



Price List  
03/2023

Alle Preise zzgl. ges. MwSt.





**Price List**  
**03/2023**

# Index

Floor/Table	p.7
Wall & ceiling	p.14
Suspension	p.70
Recessed	p.110
Bathroom	p.136
Track	p.144
Outdoor	p.160
Productcodes	p.169
Glossary	p.175



# Floor/Table

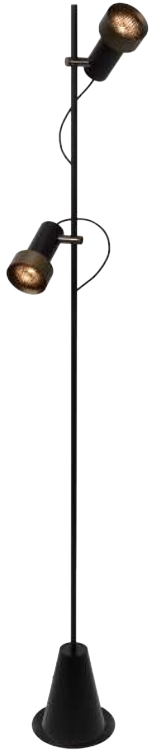

**2Thirty**  
2Thirty-Floor 1 9  
2Thirty-Floor 2 9

---



**Aude**  
Aude-Table 11

---



**Bouly**  
Bouly Table 13

---



**Aude**  
Aude-Floor 10

---



**Austere**  
Austere-Floor 12  
Austere-Table 12

---



**Scar-Led**  
Scar-Led Table 13

---





# 2Thirty-Floor 1



110V-230V - **PU** (PUSH-DIM) on armature

1 x LED array 11,8W (LED incl.) - 350mA - 1 x 1241lm - 2700K - CRI >97

Support disc (Ø 170mm x H 2mm) for uneven surfaces included.

FLOOR -

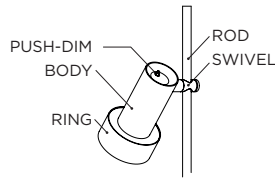

DIM	ROD + BASE black BODY black SWIVEL gunmetal RING black	ROD + BASE black BODY black SWIVEL gunmetal RING bronze	ROD + BASE black BODY black SWIVEL gunmetal RING gold	RETAIL PRICE VAT. EXCL.
●	●	●	●	
●	●	●	●	
●	●	●	●	
●	●	●	●	

+ honeycomb	EU plug		I	THF EU 12H	◆	THF EU 17H	◆	THF EU 18H	◆	I	930€
+ honeycomb	UK plug		I	THF UK 12H	◆	THF UK 17H	◆	THF UK 18H	◆	I	930€
+ honeycomb	US plug		I	THF US 12H	◆	THF US 17H	◆	THF US 18H	◆	I	930€
+ honeycomb	AU plug		I	THF AU 12H	◆	THF AU 17H	◆	THF AU 18H	◆	I	930€

# 2Thirty-Floor 2

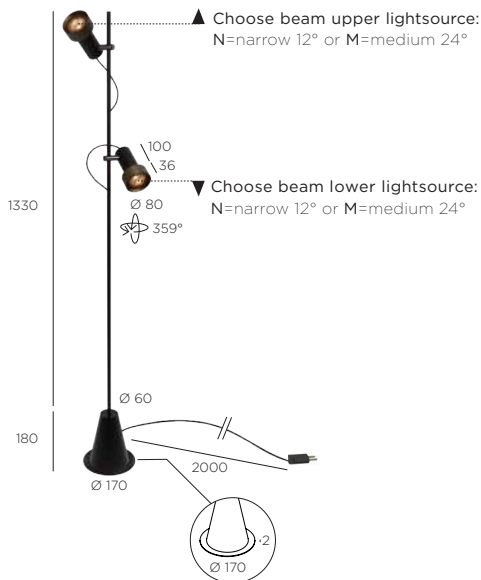

110V-230V - **PU** (PUSH-DIM) on armature

2 x LED array 11,8W (LED incl.) - 350mA - 2 x 1241lm - 2700K - CRI >97

Support disc (Ø 170mm x H 2mm) for uneven surfaces included.

FLOOR -

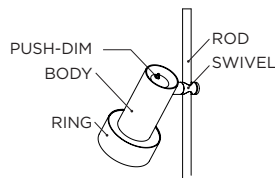

DIM	ROD + BASE black BODY black SWIVEL gunmetal RING black	ROD + BASE black BODY black SWIVEL gunmetal RING bronze	ROD + BASE black BODY black SWIVEL gunmetal RING gold	RETAIL PRICE VAT. EXCL.
●	●	●	●	
●	●	●	●	
●	●	●	●	
●	●	●	●	

+ honeycomb	EU plug		I	THF EU 22H	▲▼	THF EU 27H	▲▼	THF EU 28H	▲▼	I	1.350€
+ honeycomb	UK plug		I	THF UK 22H	▲▼	THF UK 27H	▲▼	THF UK 28H	▲▼	I	1.350€
+ honeycomb	US plug		I	THF US 22H	▲▼	THF US 27H	▲▼	THF US 28H	▲▼	I	1.350€
+ honeycomb	AU plug		I	THF AU 22H	▲▼	THF AU 27H	▲▼	THF AU 28H	▲▼	I	1.350€

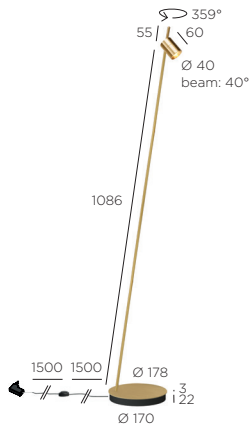

# Aude-Floor

100V-240V - plugdriver with **PU (PUSH-DIM) button on cable**  
 1 x LED array 4,32W (LED incl.) - 500mA - 2700K (487lm) or 3000K (517lm) - CRI >95  
**FLOOR** -

		COLOR LED	DIM		FRAME brass	FRAME gunmetal	FRAME bronze	FRAME nickel	RETAIL PRICE VAT. EXCL.
	EU plug	2700K		ADFL 1273					850€
	EU plug	2700K				ADFL 1274	ADFL 1277	ADFL 1279	1.010€
	UK plug	2700K		ADFL 1273UK					850€
	UK plug	2700K				ADFL 1274UK	ADFL 1277UK	ADFL 1279UK	1.010€
	US plug	2700K		ADFL 1273US					850€
	US plug	2700K				ADFL 1274US	ADFL 1277US	ADFL 1279US	1.010€
	AU plug	2700K		ADFL 1273AU					850€
	AU plug	2700K				ADFL 1274AU	ADFL 1277AU	ADFL 1279AU	1.010€
	EU plug	3000K		ADFL 1303					850€
	EU plug	3000K				ADFL 1304	ADFL 1307	ADFL 1309	1.010€
	UK plug	3000K		ADFL 1303UK					850€
	UK plug	3000K				ADFL 1304UK	ADFL 1307UK	ADFL 1309UK	1.010€
	US plug	3000K		ADFL 1303US					850€
	US plug	3000K				ADFL 1304US	ADFL 1307US	ADFL 1309US	1.010€
	AU plug	3000K		ADFL 1303AU					850€
	AU plug	3000K				ADFL 1304AU	ADFL 1307AU	ADFL 1309AU	1.010€
<b>+ honeycomb</b>	EU plug	2700K		ADFL 1273H					860€
<b>+ honeycomb</b>	EU plug	2700K				ADFL 1274H	ADFL 1277H	ADFL 1279H	1.020€
<b>+ honeycomb</b>	UK plug	2700K		ADFL 1273HUK					860€
<b>+ honeycomb</b>	UK plug	2700K				ADFL 1274HUK	ADFL 1277HUK	ADFL 1279HUK	1.020€
<b>+ honeycomb</b>	US plug	2700K		ADFL 1273HUS					860€
<b>+ honeycomb</b>	US plug	2700K				ADFL 1274HUS	ADFL 1277HUS	ADFL 1279HUS	1.020€
<b>+ honeycomb</b>	AU plug	2700K		ADFL 1273HAU					860€
<b>+ honeycomb</b>	AU plug	2700K				ADFL 1274HAU	ADFL 1277HAU	ADFL 1279HAU	1.020€
<b>+ honeycomb</b>	EU plug	3000K		ADFL 1303H					860€
<b>+ honeycomb</b>	EU plug	3000K				ADFL 1304H	ADFL 1307H	ADFL 1309H	1.020€
<b>+ honeycomb</b>	UK plug	3000K		ADFL 1303HUK					860€
<b>+ honeycomb</b>	UK plug	3000K				ADFL 1304HUK	ADFL 1307HUK	ADFL 1309HUK	1.020€
<b>+ honeycomb</b>	US plug	3000K		ADFL 1303HUS					860€
<b>+ honeycomb</b>	US plug	3000K				ADFL 1304HUS	ADFL 1307HUS	ADFL 1309HUS	1.020€
<b>+ honeycomb</b>	AU plug	3000K		ADFL 1303HAU					860€
<b>+ honeycomb</b>	AU plug	3000K				ADFL 1304HAU	ADFL 1307HAU	ADFL 1309HAU	1.020€

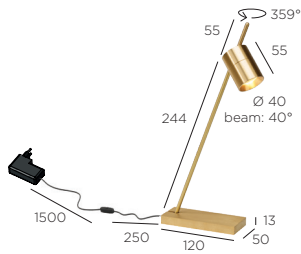

# Aude-Table

100V-240V - plugdriver with **PU (PUSH-DIM)** button on cable  
 1 x LED array 4,32W (LED incl.) - 500mA - 2700K (487lm) or 3000K (517lm) - CRI >95  
**TABLE** -

		COLOR LED	DIM	FRAME brass	FRAME black	FRAME gunmetal	FRAME bronze	FRAME nickel	RETAIL PRICE VAT. EXCL.
	EU plug	2700K		ADTA 1273	ADTA 1272				625€
	EU plug	2700K				ADTA 1274	ADTA 1277	ADTA 1279	715€
	UK plug	2700K		ADTA 1273UK	ADTA 1272UK				625€
	UK plug	2700K				ADTA 1274UK	ADTA 1277UK	ADTA 1279UK	715€
	US plug	2700K		ADTA 1273US	ADTA 1272US				625€
	US plug	2700K				ADTA 1274US	ADTA 1277US	ADTA 1279US	715€
	AU plug	2700K		ADTA 1273AU	ADTA 1272AU				625€
	AU plug	2700K				ADTA 1274AU	ADTA 1277AU	ADTA 1279AU	715€
	EU plug	3000K		ADTA 1303	ADTA 1302				625€
	EU plug	3000K				ADTA 1304	ADTA 1307	ADTA 1309	715€
	UK plug	3000K		ADTA 1303UK	ADTA 1302UK				625€
	UK plug	3000K				ADTA 1304UK	ADTA 1307UK	ADTA 1309UK	715€
	US plug	3000K		ADTA 1303US	ADTA 1302US				625€
	US plug	3000K				ADTA 1304US	ADTA 1307US	ADTA 1309US	715€
	AU plug	3000K		ADTA 1303AU	ADTA 1302AU				625€
	AU plug	3000K				ADTA 1304AU	ADTA 1307AU	ADTA 1309AU	715€
<b>+ honeycomb</b>	EU plug	2700K		ADTA 1273H	ADTA 1272H				635€
<b>+ honeycomb</b>	EU plug	2700K				ADTA 1274H	ADTA 1277H	ADTA 1279H	725€
<b>+ honeycomb</b>	UK plug	2700K		ADTA 1273HUK	ADTA 1272HUK				635€
<b>+ honeycomb</b>	UK plug	2700K				ADTA 1274HUK	ADTA 1277HUK	ADTA 1279HUK	725€
<b>+ honeycomb</b>	US plug	2700K		ADTA 1273HUS	ADTA 1272HUS				635€
<b>+ honeycomb</b>	US plug	2700K				ADTA 1274HUS	ADTA 1277HUS	ADTA 1279HUS	725€
<b>+ honeycomb</b>	AU plug	2700K		ADTA 1273HAU	ADTA 1272HAU				635€
<b>+ honeycomb</b>	AU plug	2700K				ADTA 1274HAU	ADTA 1277HAU	ADTA 1279HAU	725€
<b>+ honeycomb</b>	EU plug	3000K		ADTA 1303H	ADTA 1302H				635€
<b>+ honeycomb</b>	EU plug	3000K				ADTA 1304H	ADTA 1307H	ADTA 1309H	725€
<b>+ honeycomb</b>	UK plug	3000K		ADTA 1303HUK	ADTA 1302HUK				635€
<b>+ honeycomb</b>	UK plug	3000K				ADTA 1304HUK	ADTA 1307HUK	ADTA 1309HUK	725€
<b>+ honeycomb</b>	US plug	3000K		ADTA 1303HUS	ADTA 1302HUS				635€
<b>+ honeycomb</b>	US plug	3000K				ADTA 1304HUS	ADTA 1307HUS	ADTA 1309HUS	725€
<b>+ honeycomb</b>	AU plug	3000K		ADTA 1303HAU	ADTA 1302HAU				635€
<b>+ honeycomb</b>	AU plug	3000K				ADTA 1304HAU	ADTA 1307HAU	ADTA 1309HAU	725€

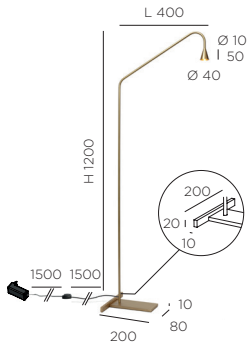

# Austere-Floor

100V-240V - plugdriver with **PU (PUSH-DIM)** button on cable  
 1 x LED array 6W (LED incl.) - 350mA - 634lm - 2700K - CRI >93  
 The base bracket is standard included and recommended for optimal stability.  
**FLOOR** -

	DIM	FRAME brass	FRAME black	FRAME white	FRAME gunmetal	FRAME bronze	FRAME nickel	RETAIL PRICE VAT. EXCL.
EU plug		HVFL 1003	HVFL 1002	HVFL 1001				780€
EU plug					HVFL 1004	HVFL 1007	HVFL 1009	920€
UK plug		HVFL 1003UK	HVFL 1002UK	HVFL 1001UK				780€
UK plug					HVFL 1004UK	HVFL 1007UK	HVFL 1009UK	920€
US plug		HVFL 1003US	HVFL 1002US	HVFL 1001US				780€
US plug					HVFL 1004US	HVFL 1007US	HVFL 1009US	920€
AU plug		HVFL 1003AU	HVFL 1002AU	HVFL 1001AU				780€
AU plug					HVFL 1004AU	HVFL 1007AU	HVFL 1009AU	920€

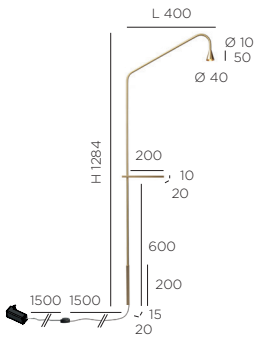

# Austere-Table

100V-240V - plugdriver with **PU (PUSH-DIM)** button on cable  
 1 x LED array 6W (LED incl.) - 350mA - 634lm - 2700K - CRI >93  
**TABLE** -

	DIM	FRAME brass	FRAME black	FRAME white	FRAME gunmetal	FRAME bronze	FRAME nickel	RETAIL PRICE VAT. EXCL.
EU plug		HVTA 1003	HVTA 1002	HVTA 1001				720€
EU plug					HVTA 1004	HVTA 1007	HVTA 1009	855€
UK plug		HVTA 1003UK	HVTA 1002UK	HVTA 1001UK				720€
UK plug					HVTA 1004UK	HVTA 1007UK	HVTA 1009UK	855€
US plug		HVTA 1003US	HVTA 1002US	HVTA 1001US				720€
US plug					HVTA 1004US	HVTA 1007US	HVTA 1009US	855€
AU plug		HVTA 1003AU	HVTA 1002AU	HVTA 1001AU				720€
AU plug					HVTA 1004AU	HVTA 1007AU	HVTA 1009AU	855€

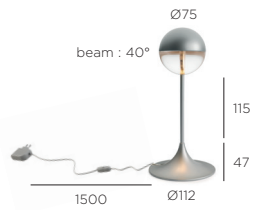

# Bouly Table

230V - EU-plugdriver with **PU (PUSH-DIM) button on cable**  
 1 x 4 LED 0.96W (LED incl.) - 350mA - 456lm - 2700K - CRI >93  
**TABLE** -

	DIM				RETAIL PRICE VAT. EXCL.	
EU plug		●	○	●	○	465€
EU plug		BOWW 5202	BOWW 5201	BOWW 5203	BOWW 5209	515€
		FRAME black	FRAME white	FRAME grey	FRAME chrome	

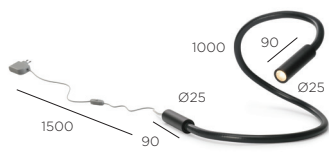

◆ Choose beam:  
 N=narrow 10° or  
 M=medium 25° or  
 W=wide 40°

# Scar-Led Table

230V - EU-plugdriver with switch on cable  
 1 x LED 0.96W (LED incl.) - 350mA - 114lm - 2700K - CRI >93  
**TABLE** -

FLEX LENGTH						RETAIL PRICE VAT. EXCL.	
L 1000	◆	●	○	●	○	300€	
		FRAME black FLEX black	FRAME white FLEX white	FRAME alu FLEX black	FRAME alu FLEX alu	FRAME bronze FLEX bronze	
		SCAR 2851◆	SCAR 2852◆	SCAR 2850◆	SCAR 2853◆	SCAR 2857◆	

# Wall & Ceiling



## 2THIRTY

2Thirty-C1	16
2Thirty-CH2	16
2Thirty-CV2	16
2Thirty-W1	17
2Thirty-W1 plug	17
2Thirty-WH2	18
2Thirty-WV2	18



## AUDETTE UP

Audette up Rounded	27
Audette-Duo up Rounded	28
Audette-Varié up Rounded	29



## AUSTERE-ELEMENTS

Austere-Elements design	38
Austere-Elements configurations	39
Austere-Elements rods & straps	43
Austere-Elements connectors	44
Austere-Elements connectors with light-element	44
Austere-Elements connectors with powercord	45
Austere-Elements connectors with light-element & powercord	46
Austere-Elements required drivers	47
Austere-Elements mounting options	47



## 7TY

7Ty up	18
--------	----



## AUDETTE-WALL

Audette W1 in	30
Audette-Duo W1 in	31
Audette-Varié W1 in	32
Audette WD1 up	32
Audette-Duo WD1 up	33
Audette-Varié WD1 up	33



## AUDE-WALL

Aude-Wall L built-in	19
Aude-Wall L plug	20



## AUDY UP

Audy 1 up Rounded	34
Audy 2 up Rounded	34
Audy-Duo 1 up Rounded	35
Audy-Duo 2 up Rounded	35



## AUSTERE

Austere-Wall built-in	48
Austere-Wall plug	48
Austere-Wall push built-in	49
Austere-Wall push plug	49



## AUDETTE UP

Audette up	21
Audette-Duo up	23
Audette-Varié up	25



## AUDY-WALL

Audy-Wall 1S	36
Audy-Wall 1S Duo	36
Audy-Wall 2S	37
Audy-Wall 2S Duo	37



## BILY

Bily 16 up	50
------------	----

# Wall & Ceiling

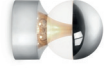

## BOULY W/C

Bouly W/C	50
Bouly W/C D+B	50



## CODE 1 / CODE 2

Code 1 GU10	51
Code 1 LED	51
Code 2 GU10	52
Code 2 LED	52
Code W G9	52
Code W LED	53



## KWA-KWA

Kwa-Kwa 1F Round	53
Kwa-Kwa 1F Square	54
Kwa-Kwa 1F +B Round	54
Kwa-Kwa 1FT Rounded LED	54
Kwa-Kwa 1FT Rectangular LED	55
Kwa-Kwa 2FT Rounded LED	55
Kwa-Kwa 2FT Rectangular LED	55
Kwa-Kwa 4FT Rounded LED	55



## MINI-PI UP

Mini-Pi 1 up	56
Mini-Pi 1 up Round	56
Mini-Pi 2 up	56
Mini-Pi 3 up	56



## NAGA

Naga	57
------	----



## PIN-UP

Pin-Up 1 Round LED	57
Pin-Up 1 Square LED	57
Pin-Up 2 LED	58
Pin-Up 4 LED	58
Pin-Up 6 LED	58



## R5 UP

R51 up GU10	59
R52 up GU10	59
R54 up GU10	59
R51 up LED	60
R52 up LED	60
R54 up LED	60



## R07 / R70 UP

R07 up	61
R70 up	61



## R110 / R111 UP

R110 up G53	61
R111 up G53	61



## SCAR-LED

Scar-Led 1FD built-in 45	62
Scar-Led 1FD built-in 60	62
Scar-Led 1FDS built-in 60	63
Scar-Led 1FD built-in 95	63
Scar-Led 1FDS built-in 95	64
Scar-Led 1FD built-up	64
Scar-Led 1FDS built-up	64
Scar-Led 1FDS built-up plug	65



## SCAR-LITE

Scar-Lite 1FD built-in	65
Scar-Lite 1FDS built-in	66
Scar-Lite 1FDS built-up	66
Scar-Lite USB built-up	67
Scar-Lite 1FDS built-up plug	67



## SIRENS W/C

Sirens W/C diffuser glass	68
Sirens W/C mirror	68
Sirens W/C frosted glass	
big mirror + edge mirror	68
Sirens W/C frosted glass	
small mirror + edge mirror	69
Sirens W/C frosted glass + edge mirror	69



◆ Choose beam:  
 N=narrow 12° or  
 M=medium 24° or  
 W=wide 40°

# 2Thirty-C1

230V (110V on demand)

1 x LED module 10W (LED incl.) - 230V - 1000lm - 2700K - CRI >90 - TRIAC dimmable

CEILING -

<ul style="list-style-type: none"> <li>● ROD + BASE black</li> <li>● BODY black</li> <li>● SWIVEL black</li> <li>● RING black</li> </ul>	<ul style="list-style-type: none"> <li>● ROD + BASE black</li> <li>● BODY black</li> <li>● SWIVEL black</li> <li>● RING bronze</li> </ul>	<ul style="list-style-type: none"> <li>● ROD + BASE black</li> <li>● BODY black</li> <li>● SWIVEL black</li> <li>● RING gold</li> </ul>	<p>RETAIL PRICE VAT. EXCL.</p>
--	---	---	------------------------------------

| THC 12223◆      THC 17223◆      THC 18223◆      | 500€

+ honeycomb | THC 12223H◆      THC 17223H◆      THC 18223H◆      | 520€

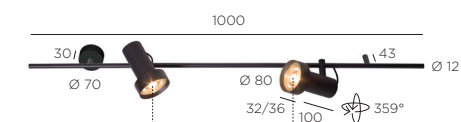

Choose beam  
left lightsource:  
 N=narrow 12° or  
 M=medium 24° or  
 W=wide 40°

Choose beam  
right lightsource:  
 N=narrow 12° or  
 M=medium 24° or  
 W=wide 40°

# 2Thirty-CH2

230V (110V on demand)

2 x LED module 10W (LED incl.) - 230V - 2 x 1000lm - 2700K - CRI >90 - TRIAC dimmable

CEILING -

<ul style="list-style-type: none"> <li>● ROD + BASE black</li> <li>● BODY black</li> <li>● SWIVEL black</li> <li>● RING black</li> </ul>	<ul style="list-style-type: none"> <li>● ROD + BASE black</li> <li>● BODY black</li> <li>● SWIVEL black</li> <li>● RING bronze</li> </ul>	<ul style="list-style-type: none"> <li>● ROD + BASE black</li> <li>● BODY black</li> <li>● SWIVEL black</li> <li>● RING gold</li> </ul>	<p>RETAIL PRICE VAT. EXCL.</p>
--	---	---	------------------------------------

| THP 22223◀▶      THP 27223◀▶      THP 28223◀▶      | 980€

+ honeycomb | THP 22223H◀▶      THP 27223H◀▶      THP 28223H◀▶      | 1.020€

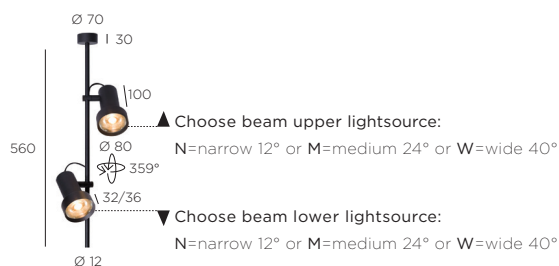

▲ Choose beam upper lightsource:  
 N=narrow 12° or M=medium 24° or W=wide 40°

▼ Choose beam lower lightsource:  
 N=narrow 12° or M=medium 24° or W=wide 40°

# 2Thirty-CV2

230V (110V on demand)

2 x LED module 10W (LED incl.) - 230V - 2 x 1000lm - 2700K - CRI >90 - TRIAC dimmable

CEILING -

<ul style="list-style-type: none"> <li>● ROD + BASE black</li> <li>● BODY black</li> <li>● SWIVEL black</li> <li>● RING black</li> </ul>	<ul style="list-style-type: none"> <li>● ROD + BASE black</li> <li>● BODY black</li> <li>● SWIVEL black</li> <li>● RING bronze</li> </ul>	<ul style="list-style-type: none"> <li>● ROD + BASE black</li> <li>● BODY black</li> <li>● SWIVEL black</li> <li>● RING gold</li> </ul>	<p>RETAIL PRICE VAT. EXCL.</p>
--	---	---	------------------------------------

| THC 22223▲▼      THC 27223▲▼      THC 28223▲▼      | 865€

+ honeycomb | THC 22223H▲▼      THC 27223H▲▼      THC 28223H▲▼      | 905€



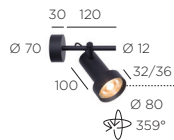

Choose beam:  
 N=narrow 12° or  
 M=medium 24° or  
 W=wide 40°

# 2Thirty-W1

230V (110V on demand)  
 1 x LED module 10W (LED incl.) - 230V - 1000lm - 2700K - CRI >90 - TRIAC dimmable  
 WALL -

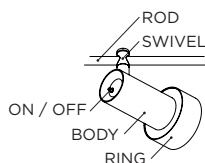

ROD + BASE black  
 BODY black  
 SWIVEL black  
 RING black

ROD + BASE black  
 BODY black  
 SWIVEL black  
 RING bronze

ROD + BASE black  
 BODY black  
 SWIVEL black  
 RING gold

RETAIL PRICE  
 VAT. EXCL.

| THW 12223 ◆ | THW 17223 ◆ | THW 18223 ◆ | 500€

+ honeycomb | THW 12223H ◆ | THW 17223H ◆ | THW 18223H ◆ | 520€

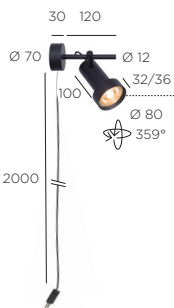

Choose beam:  
 N=narrow 12° or  
 M=medium 24° or  
 W=wide 40°

# 2Thirty-W1 plug

230V - ON/OFF on armature or \*110V - ON/OFF on armature  
 1 x LED module 10W (LED incl.) - 230V - 1000lm - 2700K - CRI >90  
 WALL -

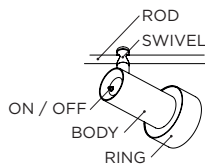

ROD + BASE black  
 BODY black  
 SWIVEL black  
 RING black

ROD + BASE black  
 BODY black  
 SWIVEL black  
 RING bronze

ROD + BASE black  
 BODY black  
 SWIVEL black  
 RING gold

RETAIL PRICE  
 VAT. EXCL.

EU plug | THWP EU 12 ◆ | THWP EU 17 ◆ | THWP EU 18 ◆ | 545€

UK plug | THWP UK 12 ◆ | THWP UK 17 ◆ | THWP UK 18 ◆ | 545€

US plug\* | THWP US 12 ◆ | THWP US 17 ◆ | THWP US 18 ◆ | on demand

AU plug | THWP AU 12 ◆ | THWP AU 17 ◆ | THWP AU 18 ◆ | 545€

+ honeycomb EU plug | THWP EU 12H ◆ | THWP EU 17H ◆ | THWP EU 18H ◆ | 565€

+ honeycomb UK plug | THWP UK 12H ◆ | THWP UK 17H ◆ | THWP UK 18H ◆ | 565€

+ honeycomb US plug\* | THWP US 12H ◆ | THWP US 17H ◆ | THWP US 18H ◆ | on demand

+ honeycomb AU plug | THWP AU 12H ◆ | THWP AU 17H ◆ | THWP AU 18H ◆ | 565€

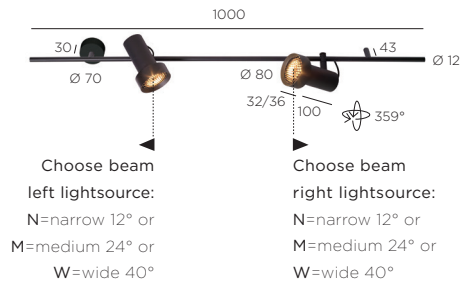

# 2Thirty-WH2

230V (110V on demand)  
 2 x LED module 10W (LED incl.) - 230V - 2 x 1000lm - 2700K - CRI >90 - TRIAC dimmable  
 WALL -

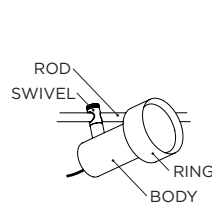

- |  |   |   |
|--|---|---|
| ROD + BASE black<br>BODY black<br>SWIVEL black<br>RING black | ROD + BASE black<br>BODY black<br>SWIVEL black<br>RING bronze | ROD + BASE black<br>BODY black<br>SWIVEL black<br>RING gold |
|--|---|---|

RETAIL PRICE  
 VAT: EXCL.

| THH 22223 ◀▶ THH 27223 ◀▶ THH 28223 ◀▶ | 980€

+ honeycomb | THH 22223H ◀▶ THH 27223H ◀▶ THH 28223H ◀▶ | 1.020€

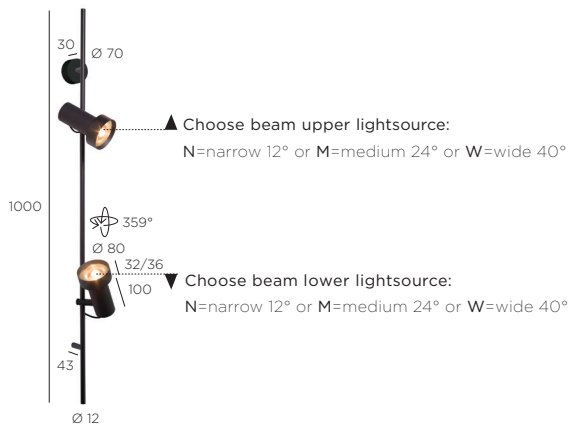

# 2Thirty-WV2

230V (110V on demand)  
 2 x LED module 10W (LED incl.) - 230V - 2 x 1000lm - 2700K - CRI >90 - TRIAC dimmable  
 WALL -

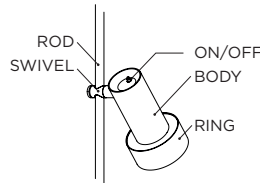

- |  |   |   |
|--|---|---|
| ROD + BASE black<br>BODY black<br>SWIVEL black<br>RING black | ROD + BASE black<br>BODY black<br>SWIVEL black<br>RING bronze | ROD + BASE black<br>BODY black<br>SWIVEL black<br>RING gold |
|--|---|---|

RETAIL PRICE  
 VAT: EXCL.

| THR 22223 ▲▼ THR 27223 ▲▼ THR 28223 ▲▼ | 980€

+ honeycomb | THR 22223H ▲▼ THR 27223H ▲▼ THR 28223H ▲▼ | 1.020€

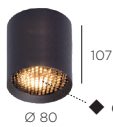

Choose beam:  
 N=narrow 12° or  
 M=medium 24° or  
 W=wide 40°

# 7Ty up

230V - driver included in base - LC (TRIAC/IGBT) dimmable  
 1 x LED array 11,8W (LED incl.) - 250mA - 913lm - 2700K - CRI >97  
 CEILING -

- |     |                                      |                                      |                                       |                                     |                                    |                            |
|-----|--------------------------------------|--------------------------------------|---------------------------------------|-------------------------------------|------------------------------------|----------------------------|
| DIM | FRAME black<br><input type="radio"/> | FRAME white<br><input type="radio"/> | FRAME bronze<br><input type="radio"/> | FRAME gold<br><input type="radio"/> | FRAME alu<br><input type="radio"/> | RETAIL PRICE<br>VAT: EXCL. |
|-----|--------------------------------------|--------------------------------------|---------------------------------------|-------------------------------------|------------------------------------|----------------------------|

LC | STUP 1002 ◆ STUP 1001 ◆ STUP 1007 ◆ STUP 1008 ◆ STUP 1009 ◆ | 295€

+ honeycomb LC | STUP 1002H ◆ STUP 1001H ◆ STUP 1007H ◆ STUP 1008H ◆ STUP 1009H ◆ | 305€

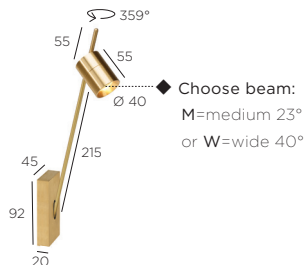

# Aude-Wall L

500mA - **required remote mounted driver see below**

1 x LED array 4,32W (LED incl.) - 500mA - 2700K (487lm) or 3000K (517lm) - CRI >95

WALL -

COLOR LED	FRAME brass	FRAME gunmetal	FRAME bronze	FRAME nickel	RETAIL PRICE VAT. EXCL.
2700K	ADWL 1273				565€
2700K		ADWL 1274	ADWL 1277	ADWL 1279	655€
3000K	ADWL 1303				565€
3000K		ADWL 1304	ADWL 1307	ADWL 1309	655€
+ honeycomb	ADWL 1273H				575€
+ honeycomb		ADWL 1274H	ADWL 1277H	ADWL 1279H	665€
+ honeycomb	ADWL 1303H				575€
+ honeycomb		ADWL 1304H	ADWL 1307H	ADWL 1309H	665€

## REQUIRED REMOTE MOUNTED DRIVER

DEVICE	DIM.	DRIVER	NET PRICE
1 x	LC (TRIAC/IGBT)	D 6WT500	16€
2 x	LC (TRIAC/IGBT)	D 10WT500	18€
1-4 x	PU (PUSH-DIM) + 1-10 (1-10V)	D 15WP*	25€
1-4 x	DA (DALI)	D 15WDA US*	28€
1-12 x	PU (PUSH-DIM) + DA (DALI) + 1-10 (1-10V)	D 40WDP*	57€

For warranty use only Trizo21® supplied LED drivers as mentioned.  
For all specs and techs about drivers, see [www.trizo21.com/drivers](http://www.trizo21.com/drivers)

driver remote mounting: driver does not fit through cutout hole of fixture  
\*110V-230V

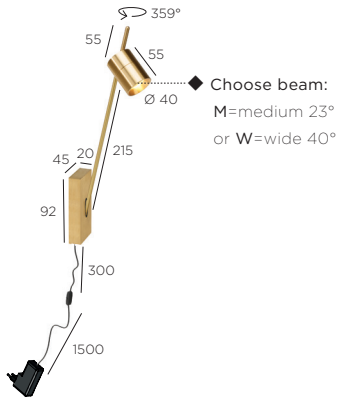

# Aude-Wall L plug

100V-240V - plugdriver with (PUSH-DIM) button on cable  
 1 x LED array 4,32W (LED incl.) - 500mA - 2700K (487lm) or 3000K (517lm) - CRI >95  
 WALL -

	COLOR LED	DIM		FRAME brass	FRAME gunmetal	FRAME bronze	FRAME nickel	RETAIL PRICE VAT. EXCL.
	EU plug	2700K		ADWL 1273EU ◆				655€
	EU plug	2700K			ADWL 1274EU ◆	ADWL 1277EU ◆	ADWL 1279EU ◆	745€
	UK plug	2700K		ADWL 1273UK ◆				655€
	UK plug	2700K			ADWL 1274UK ◆	ADWL 1277UK ◆	ADWL 1279UK ◆	745€
	US plug	2700K		ADWL 1273US ◆				655€
	US plug	2700K			ADWL 1274US ◆	ADWL 1277US ◆	ADWL 1279US ◆	745€
	AU plug	2700K		ADWL 1273AU ◆				655€
	AU plug	2700K			ADWL 1274AU ◆	ADWL 1277AU ◆	ADWL 1279AU ◆	745€
	EU plug	3000K		ADWL 1303EU ◆				655€
	EU plug	3000K			ADWL 1304EU ◆	ADWL 1307EU ◆	ADWL 1309EU ◆	745€
	UK plug	3000K		ADWL 1303UK ◆				655€
	UK plug	3000K			ADWL 1304UK ◆	ADWL 1307UK ◆	ADWL 1309UK ◆	745€
	US plug	3000K		ADWL 1303US ◆				655€
	US plug	3000K			ADWL 1304US ◆	ADWL 1307US ◆	ADWL 1309US ◆	745€
	AU plug	3000K		ADWL 1303AU ◆				655€
	AU plug	3000K			ADWL 1304AU ◆	ADWL 1307AU ◆	ADWL 1309AU ◆	745€
+ honeycomb	EU plug	2700K		ADWL 1273HEU ◆				665€
+ honeycomb	EU plug	2700K			ADWL 1274HEU ◆	ADWL 1277HEU ◆	ADWL 1279HEU ◆	755€
+ honeycomb	UK plug	2700K		ADWL 1273HUK ◆				665€
+ honeycomb	UK plug	2700K			ADWL 1274HUK ◆	ADWL 1277HUK ◆	ADWL 1279HUK ◆	755€
+ honeycomb	US plug	2700K		ADWL 1273HUS ◆				665€
+ honeycomb	US plug	2700K			ADWL 1274HUS ◆	ADWL 1277HUS ◆	ADWL 1279HUS ◆	755€
+ honeycomb	AU plug	2700K		ADWL 1273HAU ◆				665€
+ honeycomb	AU plug	2700K			ADWL 1274HAU ◆	ADWL 1277HAU ◆	ADWL 1279HAU ◆	755€
+ honeycomb	EU plug	3000K		ADWL 1303HEU ◆				665€
+ honeycomb	EU plug	3000K			ADWL 1304HEU ◆	ADWL 1307HEU ◆	ADWL 1309HEU ◆	755€
+ honeycomb	UK plug	3000K		ADWL 1303HUK ◆				665€
+ honeycomb	UK plug	3000K			ADWL 1304HUK ◆	ADWL 1307HUK ◆	ADWL 1309HUK ◆	755€
+ honeycomb	US plug	3000K		ADWL 1303HUS ◆				665€
+ honeycomb	US plug	3000K			ADWL 1304HUS ◆	ADWL 1307HUS ◆	ADWL 1309HUS ◆	755€
+ honeycomb	AU plug	3000K		ADWL 1303HAU ◆				665€
+ honeycomb	AU plug	3000K			ADWL 1304HAU ◆	ADWL 1307HAU ◆	ADWL 1309HAU ◆	755€

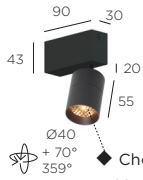

Choose beam:  
M=medium 23°  
or W=wide 40°

# Audette 1 up

230V - driver included in base - LC (TRIAC/IGBT) dimmable  
1 x LED array 6,25W (LED incl.) - 350mA - 2700K (633lm) or 3000K (673lm) - CRI >95  
CEILING - CE IP50 eco

		COLOR LED	DIM	BASE black SWIVEL brass BODY brass RING brass	BASE white SWIVEL brass BODY brass RING brass	BASE black SWIVEL black BODY black RING black	BASE white SWIVEL white BODY white RING white	RETAIL PRICE VAT. EXCL.
		2700K	LC	ADST 122333	ADST 121333			420€
		2700K	LC			ADST 122222	ADST 121111	400€
		3000K	LC	ADST 132333	ADST 131333			420€
		3000K	LC			ADST 132222	ADST 131111	400€
+ honeycomb		2700K	LC	ADST 122333H	ADST 121333H			430€
+ honeycomb		2700K	LC			ADST 122222H	ADST 121111H	410€
+ honeycomb		3000K	LC	ADST 132333H	ADST 131333H			430€
+ honeycomb		3000K	LC			ADST 132222H	ADST 131111H	410€

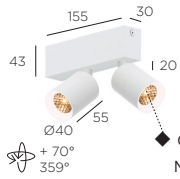

Choose beam:  
M=medium 23°  
or W=wide 40°

# Audette 2 up

230V - driver included in base - LC (TRIAC/IGBT) dimmable  
2 x LED array 6,25W (LED incl.) - 350mA - 2700K (2 x 633lm) or 3000K (2 x 673lm) - CRI >95  
CEILING - CE IP50 eco

		COLOR LED	DIM	BASE black SWIVEL brass BODY brass RING brass	BASE white SWIVEL brass BODY brass RING brass	BASE black SWIVEL black BODY black RING black	BASE white SWIVEL white BODY white RING white	RETAIL PRICE VAT. EXCL.
		2700K	LC	ADST 222333	ADST 221333			780€
		2700K	LC			ADST 222222	ADST 221111	735€
		3000K	LC	ADST 232333	ADST 231333			780€
		3000K	LC			ADST 232222	ADST 231111	735€
+ honeycomb		2700K	LC	ADST 222333H	ADST 221333H			800€
+ honeycomb		2700K	LC			ADST 222222H	ADST 221111H	755€
+ honeycomb		3000K	LC	ADST 232333H	ADST 231333H			800€
+ honeycomb		3000K	LC			ADST 232222H	ADST 231111H	755€

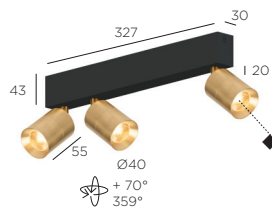

Choose beam:  
M=medium 23°  
or W=wide 40°

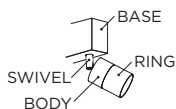

# Audette 3 up

230V - driver included in base - (TRIAC/IGBT) dimmable  
3 x LED array 6.25W (LED incl.) - 350mA - 2700K (3 x 633lm) or 3000K (3 x 673lm) - CRI >95  
CEILING -

	COLOR LED	DIM	BASE black SWIVEL brass BODY brass RING brass	BASE white SWIVEL brass BODY brass RING brass	BASE black SWIVEL black BODY black RING black	BASE white SWIVEL white BODY white RING white	RETAIL PRICE VAT. EXCL.
	2700K		ADST 322333	ADST 321333			1.135€
	2700K				ADST 322222	ADST 321111	1.065€
	3000K		ADST 332333	ADST 331333			1.135€
	3000K				ADST 332222	ADST 331111	1.065€
+ honeycomb	2700K		ADST 322333H	ADST 321333H			1.165€
+ honeycomb	2700K				ADST 322222H	ADST 321111H	1.095€
+ honeycomb	3000K		ADST 332333H	ADST 331333H			1.165€
+ honeycomb	3000K				ADST 332222H	ADST 331111H	1.095€

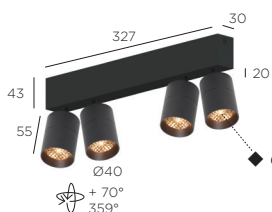

Choose beam:  
M=medium 23°  
or W=wide 40°

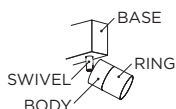

# Audette 4 up

230V - driver included in base - (TRIAC/IGBT) dimmable  
4 x LED array 6.25W (LED incl.) - 350mA - 2700K (4 x 633lm) or 3000K (4 x 673lm) - CRI >95  
CEILING -

	COLOR LED	DIM	BASE black SWIVEL brass BODY brass RING brass	BASE white SWIVEL brass BODY brass RING brass	BASE black SWIVEL black BODY black RING black	BASE white SWIVEL white BODY white RING white	RETAIL PRICE VAT. EXCL.
	2700K		ADST 422333	ADST 421333			1.490€
	2700K				ADST 422222	ADST 421111	1.400€
	3000K		ADST 432333	ADST 431333			1.490€
	3000K				ADST 432222	ADST 431111	1.400€
+ honeycomb	2700K		ADST 422333H	ADST 421333H			1.530€
+ honeycomb	2700K				ADST 422222H	ADST 421111H	1.440€
+ honeycomb	3000K		ADST 432333H	ADST 431333H			1.530€
+ honeycomb	3000K				ADST 432222H	ADST 431111H	1.440€

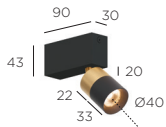

Choose beam:  
M=medium 23°  
or W=wide 40°

# Audette-Duo 1 up

230V - driver included in base - (TRIAC/IGBT) dimmable  
1 x LED array 6,25W (LED incl.) - 350mA - 2700K (633lm) or 3000K (673lm) - CRI >95  
CEILING -

		COLOR LED	DIM	BASE black SWIVEL brass BODY brass RING black	BASE white SWIVEL brass BODY brass RING white	BASE black SWIVEL black BODY black RING brass	BASE white SWIVEL white BODY white RING brass	RETAIL PRICE VAT. EXCL.
	2700K			●	○	●	○	400€
	2700K			●	○	●	○	420€
	3000K			●	○	●	○	400€
	3000K			●	○	●	○	420€
+ honeycomb	2700K			●	○	●	○	410€
+ honeycomb	2700K			●	○	●	○	430€
+ honeycomb	3000K			●	○	●	○	410€
+ honeycomb	3000K			●	○	●	○	430€

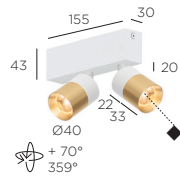

Choose beam:  
M=medium 23°  
or W=wide 40°

# Audette-Duo 2 up

230V - driver included in base - (TRIAC/IGBT) dimmable  
2 x LED array 6,25W (LED incl.) - 350mA - 2700K (2 x 633lm) or 3000K (2 x 673lm) - CRI >95  
CEILING -

		COLOR LED	DIM	BASE black SWIVEL brass BODY brass RING black	BASE white SWIVEL brass BODY brass RING white	BASE black SWIVEL black BODY black RING brass	BASE white SWIVEL white BODY white RING brass	RETAIL PRICE VAT. EXCL.
	2700K			●	○	●	○	735€
	2700K			●	○	●	○	775€
	3000K			●	○	●	○	735€
	3000K			●	○	●	○	775€
+ honeycomb	2700K			●	○	●	○	755€
+ honeycomb	2700K			●	○	●	○	795€
+ honeycomb	3000K			●	○	●	○	755€
+ honeycomb	3000K			●	○	●	○	795€

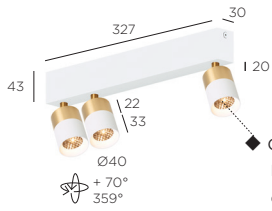

Choose beam:  
M=medium 23°  
or W=wide 40°

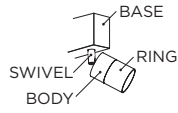

	COLOR LED	DIM	BASE black	SWIVEL brass	BODY brass	RING black	BASE white	SWIVEL brass	BODY brass	RING white	BASE black	SWIVEL black	BODY black	RING brass	BASE white	SWIVEL white	BODY white	RING brass	RETAIL PRICE VAT. EXCL.
	2700K	LC	●	●	●	●	○	●	●	○	●	●	●	●	○	○	○	○	1.065€
	2700K	LC																	1.135€
	3000K	LC	●	●	●	●	○	●	●	○	●	●	●	●	○	○	○	○	1.065€
	3000K	LC																	1.135€
+ honeycomb	2700K	LC	●	●	●	●	○	●	●	○	●	●	●	●	○	○	○	○	1.095€
+ honeycomb	2700K	LC																	1.165€
+ honeycomb	3000K	LC	●	●	●	●	○	●	●	○	●	●	●	●	○	○	○	○	1.095€
+ honeycomb	3000K	LC																	1.165€

## Audette-Duo 4 up

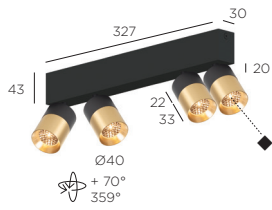

Choose beam:  
M=medium 23°  
or W=wide 40°

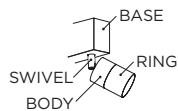

	COLOR LED	DIM	BASE black	SWIVEL brass	BODY brass	RING black	BASE white	SWIVEL brass	BODY brass	RING white	BASE black	SWIVEL black	BODY black	RING brass	BASE white	SWIVEL white	BODY white	RING brass	RETAIL PRICE VAT. EXCL.
	2700K	LC	●	●	●	●	○	●	●	○	●	●	●	●	○	○	○	○	1.400€
	2700K	LC																	1.490€
	3000K	LC	●	●	●	●	○	●	●	○	●	●	●	●	○	○	○	○	1.400€
	3000K	LC																	1.490€
+ honeycomb	2700K	LC	●	●	●	●	○	●	●	○	●	●	●	●	○	○	○	○	1.440€
+ honeycomb	2700K	LC																	1.530€
+ honeycomb	3000K	LC	●	●	●	●	○	●	●	○	●	●	●	●	○	○	○	○	1.440€
+ honeycomb	3000K	LC																	1.530€



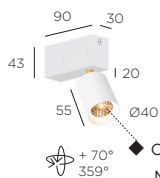

Choose beam:  
 M=medium 23°  
 or W=wide 40°

# Audette-Varié 1 up

230V - driver included in base - **LC** (TRIAC/IGBT) dimmable  
 1 x LED array 6,25W (LED incl.) - 350mA - 2700K (633lm) or 3000K (673lm) - CRI >95  
**CEILING** -

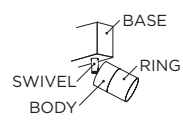

	COLOR LED	DIM	BASE black	SWIVEL brass	BODY black	RING black	BASE white	SWIVEL brass	BODY white	RING white	RETAIL PRICE VAT. EXCL.
	2700K		<input type="radio"/>	<input type="radio"/>	<input type="radio"/>	<input type="radio"/>	<input type="radio"/>	<input type="radio"/>	<input type="radio"/>	<input type="radio"/>	400€
	3000K		<input type="radio"/>	<input type="radio"/>	<input type="radio"/>	<input type="radio"/>	<input type="radio"/>	<input type="radio"/>	<input type="radio"/>	<input type="radio"/>	400€
<b>+ honeycomb</b>	2700K		<input type="radio"/>	<input type="radio"/>	<input type="radio"/>	<input type="radio"/>	<input type="radio"/>	<input type="radio"/>	<input type="radio"/>	<input type="radio"/>	410€
<b>+ honeycomb</b>	3000K		<input type="radio"/>	<input type="radio"/>	<input type="radio"/>	<input type="radio"/>	<input type="radio"/>	<input type="radio"/>	<input type="radio"/>	<input type="radio"/>	410€

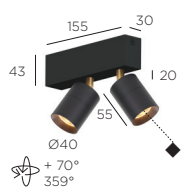

Choose beam:  
 M=medium 23°  
 or W=wide 40°

# Audette-Varié 2 up

230V - driver included in base - **LC** (TRIAC/IGBT) dimmable  
 2 x LED array 6,25W (LED incl.) - 350mA - 2700K (2 x 633lm) or 3000K (2 x 673lm) - CRI >95  
**CEILING** -

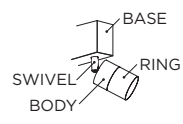

	COLOR LED	DIM	BASE black	SWIVEL brass	BODY black	RING black	BASE white	SWIVEL brass	BODY white	RING white	RETAIL PRICE VAT. EXCL.
	2700K		<input type="radio"/>	<input type="radio"/>	<input type="radio"/>	<input type="radio"/>	<input type="radio"/>	<input type="radio"/>	<input type="radio"/>	<input type="radio"/>	735€
	3000K		<input type="radio"/>	<input type="radio"/>	<input type="radio"/>	<input type="radio"/>	<input type="radio"/>	<input type="radio"/>	<input type="radio"/>	<input type="radio"/>	735€
<b>+ honeycomb</b>	2700K		<input type="radio"/>	<input type="radio"/>	<input type="radio"/>	<input type="radio"/>	<input type="radio"/>	<input type="radio"/>	<input type="radio"/>	<input type="radio"/>	755€
<b>+ honeycomb</b>	3000K		<input type="radio"/>	<input type="radio"/>	<input type="radio"/>	<input type="radio"/>	<input type="radio"/>	<input type="radio"/>	<input type="radio"/>	<input type="radio"/>	755€

# Audette-Varié 3 up

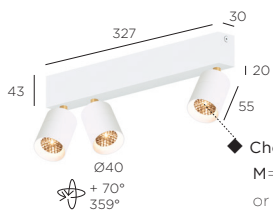

Choose beam:  
M=medium 23°  
or W=wide 40°

230V - driver included in base - LC (TRIAC/IGBT) dimmable

3 x LED array 6.25W (LED incl.) - 350mA - 2700K (3 x 633lm) or 3000K (3 x 673lm) - CRI >95

CEILING -

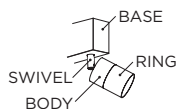

	COLOR LED	DIM	BASE black	SWIVEL brass	BODY black	RING black	BASE white	SWIVEL brass	BODY white	RING white	RETAIL PRICE VAT. EXCL.
	2700K		<input type="radio"/>	<input type="radio"/>	<input type="radio"/>	<input type="radio"/>	<input type="radio"/>	<input type="radio"/>	<input type="radio"/>	<input type="radio"/>	1.065€
	3000K		<input type="radio"/>	<input type="radio"/>	<input type="radio"/>	<input type="radio"/>	<input type="radio"/>	<input type="radio"/>	<input type="radio"/>	<input type="radio"/>	1.065€
+ honeycomb	2700K		<input type="radio"/>	<input type="radio"/>	<input type="radio"/>	<input type="radio"/>	<input type="radio"/>	<input type="radio"/>	<input type="radio"/>	<input type="radio"/>	1.095€
+ honeycomb	3000K		<input type="radio"/>	<input type="radio"/>	<input type="radio"/>	<input type="radio"/>	<input type="radio"/>	<input type="radio"/>	<input type="radio"/>	<input type="radio"/>	1.095€

# Audette-Varié 4 up

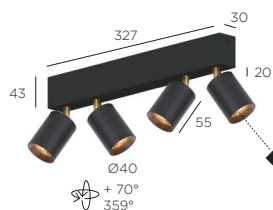

Choose beam:  
M=medium 23°  
or W=wide 40°

230V - driver included in base - LC (TRIAC/IGBT) dimmable

4 x LED array 6.25W (LED incl.) - 350mA - 2700K (4 x 633lm) or 3000K (4 x 673lm) - CRI >95

CEILING -

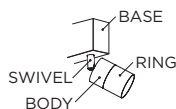

	COLOR LED	DIM	BASE black	SWIVEL brass	BODY black	RING black	BASE white	SWIVEL brass	BODY white	RING white	RETAIL PRICE VAT. EXCL.
	2700K		<input type="radio"/>	<input type="radio"/>	<input type="radio"/>	<input type="radio"/>	<input type="radio"/>	<input type="radio"/>	<input type="radio"/>	<input type="radio"/>	1.400€
	3000K		<input type="radio"/>	<input type="radio"/>	<input type="radio"/>	<input type="radio"/>	<input type="radio"/>	<input type="radio"/>	<input type="radio"/>	<input type="radio"/>	1.400€
+ honeycomb	2700K		<input type="radio"/>	<input type="radio"/>	<input type="radio"/>	<input type="radio"/>	<input type="radio"/>	<input type="radio"/>	<input type="radio"/>	<input type="radio"/>	1.440€
+ honeycomb	3000K		<input type="radio"/>	<input type="radio"/>	<input type="radio"/>	<input type="radio"/>	<input type="radio"/>	<input type="radio"/>	<input type="radio"/>	<input type="radio"/>	1.440€

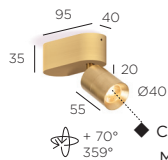

Choose beam:  
M=medium 23°  
or W=wide 40°

# Audette 1 up Rounded

230V - driver included in base - (TRIAC/IGBT) dimmable

1 x LED array 6.25W (LED incl.) - 350mA - 2700K (633lm) or 3000K (673lm) - CRI >95

CEILING -

COLOR LED	DIM	BASE brass	SWIVEL brass	BODY brass	RING brass	BASE black	SWIVEL black	BODY black	RING black	BASE white	SWIVEL white	BODY white	RING white	BASE gunmetal	SWIVEL gunmetal	BODY gunmetal	RING gunmetal	BASE bronze	SWIVEL bronze	BODY bronze	RING bronze	BASE nickel	SWIVEL nickel	BODY nickel	RING nickel	RETAIL PRICE VAT. EXCL.
2700K		●	●	●	●	●	●	●	●	○	○	○	○	●	●	●	●	●	●	●	●	○	○	○	○	495€
2700K						●	●	●	●	○	○	○	○													415€
2700K														●	●	●	●	●	●	●	●	○	○	○	○	565€
3000K		●	●	●	●	●	●	●	●	○	○	○	○													495€
3000K						●	●	●	●	○	○	○	○													415€
3000K														●	●	●	●	●	●	●	●	○	○	○	○	565€
+ honeycomb	2700K																									505€
+ honeycomb	2700K					●	●	●	●	○	○	○	○													425€
+ honeycomb	2700K													●	●	●	●	●	●	●	●	○	○	○	○	575€
+ honeycomb	3000K																									505€
+ honeycomb	3000K					●	●	●	●	○	○	○	○													425€
+ honeycomb	3000K													●	●	●	●	●	●	●	●	○	○	○	○	575€



Choose beam:  
M=medium 23°  
or W=wide 40°

# Audette 2 up Rounded

230V - driver included in base - (TRIAC/IGBT) dimmable

2 x LED array 6.25W (LED incl.) - 350mA - 2700K (2 x 633lm) or 3000K (2 x 673lm) - CRI >95

CEILING -

COLOR LED	DIM	BASE brass	SWIVEL brass	BODY brass	RING brass	BASE black	SWIVEL black	BODY black	RING black	BASE white	SWIVEL white	BODY white	RING white	BASE gunmetal	SWIVEL gunmetal	BODY gunmetal	RING gunmetal	BASE bronze	SWIVEL bronze	BODY bronze	RING bronze	BASE nickel	SWIVEL nickel	BODY nickel	RING nickel	RETAIL PRICE VAT. EXCL.
2700K		●	●	●	●	●	●	●	●	○	○	○	○	●	●	●	●	●	●	●	●	○	○	○	○	905€
2700K						●	●	●	●	○	○	○	○													745€
2700K														●	●	●	●	●	●	●	●	○	○	○	○	1.040€
3000K		●	●	●	●	●	●	●	●	○	○	○	○													905€
3000K						●	●	●	●	○	○	○	○													745€
3000K														●	●	●	●	●	●	●	●	○	○	○	○	1.040€
+ honeycomb	2700K																									925€
+ honeycomb	2700K					●	●	●	●	○	○	○	○													765€
+ honeycomb	2700K													●	●	●	●	●	●	●	●	○	○	○	○	1.060€
+ honeycomb	3000K																									925€
+ honeycomb	3000K					●	●	●	●	○	○	○	○													765€
+ honeycomb	3000K													●	●	●	●	●	●	●	●	○	○	○	○	1.060€

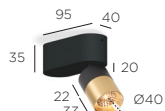

Choose beam:  
M=medium 23°  
or W=wide 40°

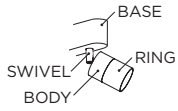

# Audette-Duo 1 up Rounded

230V - driver included in base - LC (TRIAC/IGBT) dimmable  
1 x LED array 6.25W (LED incl.) - 350mA - 2700K (633lm) or 3000K (673lm) - CRI >95  
CEILING -

	COLOR LED	DIM	BASE brass SWIVEL brass BODY brass RING black	BASE brass SWIVEL brass BODY brass RING white	BASE black SWIVEL black BODY black RING brass	BASE white SWIVEL white BODY white RING brass	BASE black SWIVEL brass BODY brass RING black	BASE white SWIVEL brass BODY brass RING white	RETAIL PRICE VAT. EXCL.
	2700K		● ● ● ●	● ● ● ●	● ● ● ●	○ ○ ○ ●	● ● ● ●	○ ● ● ○	470€
	2700K				ADRT 122223	ADRT 121113			440€
	2700K						ADRT 122332	ADRT 121331	415€
	3000K		ADRT 133332	ADRT 133331					470€
	3000K				ADRT 132223	ADRT 131113			440€
	3000K						ADRT 132332	ADRT 131331	415€
+ honeycomb	2700K		ADRT 123332H	ADRT 123331H					480€
+ honeycomb	2700K				ADRT 122223H	ADRT 121113H			450€
+ honeycomb	2700K						ADRT 122332H	ADRT 121331H	425€
+ honeycomb	3000K		ADRT 133332H	ADRT 133331H					480€
+ honeycomb	3000K				ADRT 132223H	ADRT 131113H			450€
+ honeycomb	3000K						ADRT 132332H	ADRT 131331H	425€

gunmetal, bronze and nickel combinations on demand

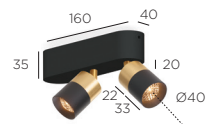

Choose beam:  
M=medium 23°  
or W=wide 40°

# Audette-Duo 2 up Rounded

230V - driver included in base - LC (TRIAC/IGBT) dimmable  
2 x LED array 6.25W (LED incl.) - 350mA - 2700K (2 x 633lm) or 3000K (2 x 673lm) - CRI >95  
CEILING -

	COLOR LED	DIM	BASE brass SWIVEL brass BODY brass RING black	BASE brass SWIVEL brass BODY brass RING white	BASE black SWIVEL black BODY black RING brass	BASE white SWIVEL white BODY white RING brass	BASE black SWIVEL brass BODY brass RING black	BASE white SWIVEL brass BODY brass RING white	RETAIL PRICE VAT. EXCL.
	2700K		● ● ● ●	● ● ● ●	● ● ● ●	○ ○ ○ ●	● ● ● ●	○ ● ● ○	855€
	2700K				ADRT 222223	ADRT 221113			790€
	2700K						ADRT 222332	ADRT 221331	745€
	3000K		ADRT 233332	ADRT 233331					855€
	3000K				ADRT 232223	ADRT 231113			790€
	3000K						ADRT 232332	ADRT 231331	745€
+ honeycomb	2700K		ADRT 223332H	ADRT 223331H					875€
+ honeycomb	2700K				ADRT 222223H	ADRT 221113H			810€
+ honeycomb	2700K						ADRT 222332H	ADRT 221331H	765€
+ honeycomb	3000K		ADRT 233332H	ADRT 233331H					875€
+ honeycomb	3000K				ADRT 232223H	ADRT 231113H			810€
+ honeycomb	3000K						ADRT 232332H	ADRT 231331H	765€

gunmetal, bronze and nickel combinations on demand



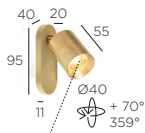

◆ Choose beam:  
M=medium 23°  
or W=wide 40°

# Audette W1 in Rounded

500mA - **required remote mounted driver see below**

1 x LED array 4,32W (LED incl.) - 500mA - 2700K (487lm) or 3000K (517lm) - CRI >95

WALL -

COLOR LED	BASE brass	SWIVEL brass	BODY brass	RING brass	BASE black	SWIVEL black	BODY black	RING black	BASE white	SWIVEL white	BODY white	RING white	BASE gunmetal	SWIVEL gunmetal	BODY gunmetal	RING gunmetal	BASE bronze	SWIVEL bronze	BODY bronze	RING bronze	BASE nickel	SWIVEL nickel	BODY nickel	RING nickel	RETAIL PRICE VAT. EXCL.
2700K	AWBI 23333◆																								400€
2700K					AWBI 22222◆				AWBI 21111◆																375€
2700K													AWBI 24444◆				AWBI 27777◆						AWBI 29999◆		455€
3000K	AWBI 33333◆																								400€
3000K					AWBI 32222◆				AWBI 31111◆																375€
3000K													AWBI 34444◆				AWBI 37777◆						AWBI 39999◆		455€
+ honeycomb	AWBI 23333H◆																								410€
+ honeycomb					AWBI 22222H◆				AWBI 21111H◆																385€
+ honeycomb													AWBI 24444H◆				AWBI 27777H◆						AWBI 29999H◆		465€
+ honeycomb	AWBI 33333H◆																								410€
+ honeycomb					AWBI 32222H◆				AWBI 31111H◆																385€
+ honeycomb													AWBI 34444H◆				AWBI 37777H◆						AWBI 39999H◆		465€

## REQUIRED REMOTE MOUNTED DRIVER

DEVICE	DIM.
1 x	LC (TRIAC/IGBT)
2 x	LC (TRIAC/IGBT)
1-4 x	PU (PUSH-DIM) + 1-10 (1-10V)
1-4 x	DA (DALI)
1-12 x	PU (PUSH-DIM) + DA (DALI) + 1-10 (1-10V)

DRIVER	NET PRICE
D 6WT500	16€
D 10WT500	18€
D 15WP*	25€
D 15WDA US*	28€
D 40WDP*	57€

For warranty use only Trizo21® supplied LED drivers as mentioned.  
For all specs and techs about drivers, see [www.trizo21.com/drivers](http://www.trizo21.com/drivers)

driver remote mounting: driver does not fit through cutout hole of fixture  
\*110V-230V

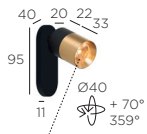

◆ Choose beam:  
M=medium 23°  
or W=wide 40°

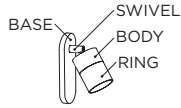

# Audette-Duo W1 in Rounded

500mA - **required remote mounted driver see below**

1 x LED array 4,32W (LED incl.) - 500mA - 2700K (487lm) or 3000K (517lm) - CRI >95

WALL -

	COLOR LED	BASE	SWIVEL	BODY	RING	RETAIL PRICE VAT. EXCL.	
	BASE brass SWIVEL brass BODY brass RING black	BASE brass SWIVEL brass BODY brass RING white	BASE black SWIVEL black BODY black RING brass	BASE white SWIVEL white BODY white RING brass	BASE black SWIVEL brass BODY brass RING black	BASE white SWIVEL brass BODY brass RING white	
	2700K	AWBI 23332◆	AWBI 23331◆			375€	
	2700K			AWBI 22223◆	AWBI 21113◆	400€	
	3000K	AWBI 33332◆	AWBI 33331◆			375€	
	3000K			AWBI 32223◆	AWBI 31113◆	400€	
+ honeycomb	2700K	AWBI 23332H◆	AWBI 23331H◆			385€	
+ honeycomb	2700K			AWBI 22223H◆	AWBI 21113H◆	410€	
+ honeycomb	3000K	AWBI 33332H◆	AWBI 33331H◆			385€	
+ honeycomb	3000K			AWBI 32223H◆	AWBI 31113H◆	410€	

## REQUIRED REMOTE MOUNTED DRIVER

DEVICE	DIM.	DRIVER	NET PRICE
1 x	LC (TRIAC/IGBT)	D 6WT500	16€
2 x	LC (TRIAC/IGBT)	D 10WT500	18€
1-4 x	PU (PUSH-DIM) + 1-10 (1-10V)	D 15WP*	25€
1-4 x	DA (DALI)	D 15WDA US*	28€
1-12 x	PU (PUSH-DIM) + DA (DALI) + 1-10 (1-10V)	D 40WDP*	57€

For warranty use only Trizo21® supplied LED drivers as mentioned.  
For all specs and techs about drivers, see [www.trizo21.com/drivers](http://www.trizo21.com/drivers)

driver remote mounting; driver does not fit through cutout hole of fixture  
\*110V-230V

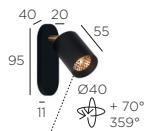

◆ Choose beam:  
M=medium 23°  
or W=wide 40°

# Audette-Varié W1 in Rounded

500mA - **required remote mounted driver see below**

1 x LED array 4.32W (LED incl.) - 500mA - 2700K (487lm) or 3000K (517lm) - CRI >95

WALL -

		COLOR LED	BASE black SWIVEL brass BODY black RING black	BASE white SWIVEL brass BODY white RING white	RETAIL PRICE VAT. EXCL.
		2700K	AWBI 22322◆	AWBI 21311◆	375€
		3000K	AWBI 32322◆	AWBI 31311◆	375€
+ honeycomb		2700K	AWBI 22322H◆	AWBI 21311H◆	385€
+ honeycomb		3000K	AWBI 32322H◆	AWBI 31311H◆	385€

## REQUIRED REMOTE MOUNTED DRIVER

DEVICE	DIM.	DRIVER	NET PRICE
1 x	LC (TRIAC/IGBT)	D 6WTS500	16€
2 x	LC (TRIAC/IGBT)	D 10WTS500	18€
1-4 x	PU (PUSH-DIM) + 1-10 (1-10V)	D 15WP*	25€
1-4 x	DA (DALI)	D 15WDA US*	28€
1-12 x	PU (PUSH-DIM) + DA (DALI) + 1-10 (1-10V)	D 40WDP*	57€

For warranty use only Trizo21® supplied LED drivers as mentioned.  
For all specs and techs about drivers, see [www.trizo21.com/drivers](http://www.trizo21.com/drivers)

driver remote mounting: driver does not fit through cutout hole of fixture  
\*110V-230V

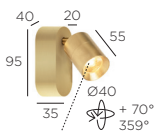

◆ Choose beam:  
M=medium 23°  
or W=wide 40°

# Audette WD1 up Rounded

230V - driver included in base - LC (TRIAC/IGBT) dimmable

1 x LED array 4.32W (LED incl.) - 500mA - 2700K (487lm) or 3000K (517lm) - CRI >95

WALL -

		COLOR LED	DIM	BASE brass SWIVEL brass BODY brass RING brass	BASE black SWIVEL black BODY black RING black	BASE white SWIVEL white BODY white RING white	BASE gunmetal SWIVEL gunmetal BODY gunmetal RING gunmetal	BASE bronze SWIVEL bronze BODY bronze RING bronze	BASE nickel SWIVEL nickel BODY nickel RING nickel	RETAIL PRICE VAT. EXCL.
		2700K	LC	AWBU 23333◆						495€
		2700K	LC		AWBU 22222◆	AWBU 21111◆				415€
		2700K	LC				AWBU 24444◆	AWBU 27777◆	AWBU 29999◆	565€
		3000K	LC	AWBU 33333◆						495€
		3000K	LC		AWBU 32222◆	AWBU 31111◆				415€
		3000K	LC				AWBU 34444◆	AWBU 37777◆	AWBU 39999◆	565€
+ honeycomb		2700K	LC	AWBU 23333H◆						505€
+ honeycomb		2700K	LC		AWBU 22222H◆	AWBU 21111H◆				425€
+ honeycomb		2700K	LC				AWBU 24444H◆	AWBU 27777H◆	AWBU 29999H◆	575€
+ honeycomb		3000K	LC	AWBU 33333H◆						505€
+ honeycomb		3000K	LC		AWBU 32222H◆	AWBU 31111H◆				425€
+ honeycomb		3000K	LC				AWBU 34444H◆	AWBU 37777H◆	AWBU 39999H◆	575€



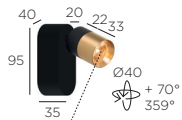

Choose beam:  
M=medium 23°  
or W=wide 40°

# Audette-Duo WD1 up Rounded

230V - driver included in base - LC (TRIAC/IGBT) dimmable

1 x LED array 4,32W (LED incl.) - 500mA - 2700K (487lm) or 3000K (517lm) - CRI >95

WALL - CE IP50 eco

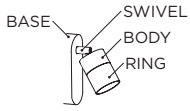

	COLOR LED	DIM	BASE	SWIVEL	BODY	RING	RETAIL PRICE VAT. EXCL.		
			● BASE brass	● SWIVEL brass	● BODY brass	● RING black			
			● BASE brass	● SWIVEL brass	● BODY brass	○ RING white			
			● BASE black	● SWIVEL black	● BODY black	● RING brass			
			○ BASE white	○ SWIVEL white	○ BODY white	● RING brass			
			● BASE black	● SWIVEL brass	● BODY brass	● RING black			
			○ BASE white	● SWIVEL brass	● BODY brass	○ RING white			
2700K	LC	▲	AWBU 23332◆	AWBU 23331◆			475€		
2700K	LC	▲			AWBU 22223◆	AWBU 21113◆	435€		
2700K	LC	▲				AWBU 22332◆	AWBU 21331◆	415€	
3000K	LC	▲	AWBU 33332◆	AWBU 33331◆			475€		
3000K	LC	▲			AWBU 32223◆	AWBU 31113◆	435€		
3000K	LC	▲				AWBU 32332◆	AWBU 31331◆	415€	
+ honeycomb	2700K	LC	▲	AWBU 23332H◆	AWBU 23331H◆			485€	
+ honeycomb	2700K	LC	▲			AWBU 22223H◆	AWBU 21113H◆	445€	
+ honeycomb	2700K	LC	▲				AWBU 22332H◆	AWBU 21331H◆	425€
+ honeycomb	3000K	LC	▲	AWBU 33332H◆	AWBU 33331H◆			485€	
+ honeycomb	3000K	LC	▲			AWBU 32223H◆	AWBU 31113H◆	445€	
+ honeycomb	3000K	LC	▲				AWBU 32332H◆	AWBU 31331H◆	425€

gunmetal, bronze and nickel combinations on demand

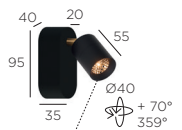

Choose beam:  
M=medium 23°  
or W=wide 40°

# Audette-Varié WD1 up Rounded

230V - driver included in base - LC (TRIAC/IGBT) dimmable

1 x LED array 4,32W (LED incl.) - 500mA - 2700K (487lm) or 3000K (517lm) - CRI >95

WALL - CE IP50 eco

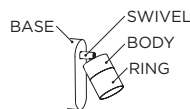

	COLOR LED	DIM	BASE	SWIVEL	BODY	RING	RETAIL PRICE VAT. EXCL.
			● BASE black	● SWIVEL brass	● BODY black	● RING black	
			○ BASE white	● SWIVEL brass	○ BODY white	○ RING white	
2700K	LC	▲	AWBU 22322◆		AWBU 21311◆		415€
3000K	LC	▲	AWBU 32322◆		AWBU 31311◆		415€
+ honeycomb	2700K	LC	▲	AWBU 22322H◆	AWBU 21311H◆		425€
+ honeycomb	3000K	LC	▲	AWBU 32322H◆	AWBU 31311H◆		425€

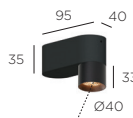

◆ Choose beam:  
M=medium 23°  
or W=wide 40°

# Audy 1 up Rounded

230V - driver included in base - (TRIAC/IGBT) dimmable  
1 x LED array 4,32W (LED incl.) - 500mA - 2700K (487lm) or 3000K (517lm) - CRI >95  
CEILING -

	COLOR LED	DIM	BASE brass RING brass	BASE black RING black	BASE white RING white	BASE gunmetal RING gunmetal	BASE bronze RING bronze	BASE nickel RING nickel	RETAIL PRICE VAT. EXCL.
	2700K		AYUP 2133◆	AYUP 2122◆	AYUP 2111◆	AYUP 2144◆	AYUP 2177◆	AYUP 2199◆	400€
	2700K								340€
	2700K								485€
	3000K		AYUP 3133◆	AYUP 3122◆	AYUP 3111◆	AYUP 3144◆	AYUP 3177◆	AYUP 3199◆	400€
	3000K								340€
	3000K								485€
+ honeycomb	2700K		AYUP 2133H◆	AYUP 2122H◆	AYUP 2111H◆	AYUP 2144H◆	AYUP 2177H◆	AYUP 2199H◆	410€
+ honeycomb	2700K								350€
+ honeycomb	2700K								495€
+ honeycomb	3000K		AYUP 3133H◆	AYUP 3122H◆	AYUP 3111H◆	AYUP 3144H◆	AYUP 3177H◆	AYUP 3199H◆	410€
+ honeycomb	3000K								350€
+ honeycomb	3000K								495€

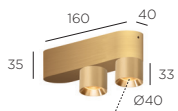

◆ Choose beam:  
M=medium 23°  
or W=wide 40°

# Audy 2 up Rounded

230V - driver included in base - (TRIAC/IGBT) dimmable  
2 x LED array 4,32W (LED incl.) - 500mA - 2700K (2 x 487lm) or 3000K (2 x 517lm) - CRI >95  
CEILING -

	COLOR LED	DIM	BASE brass RING brass	BASE black RING black	BASE white RING white	BASE gunmetal RING gunmetal	BASE bronze RING bronze	BASE nickel RING nickel	RETAIL PRICE VAT. EXCL.
	2700K		AYUP 2233◆	AYUP 2222◆	AYUP 2211◆	AYUP 2244◆	AYUP 2277◆	AYUP 2299◆	710€
	2700K								600€
	2700K								840€
	3000K		AYUP 3233◆	AYUP 3222◆	AYUP 3211◆	AYUP 3244◆	AYUP 3277◆	AYUP 3299◆	710€
	3000K								600€
	3000K								840€
+ honeycomb	2700K		AYUP 2233H◆	AYUP 2222H◆	AYUP 2211H◆	AYUP 2244H◆	AYUP 2277H◆	AYUP 2299H◆	730€
+ honeycomb	2700K								620€
+ honeycomb	2700K								860€
+ honeycomb	3000K		AYUP 3233H◆	AYUP 3222H◆	AYUP 3211H◆	AYUP 3244H◆	AYUP 3277H◆	AYUP 3299H◆	730€
+ honeycomb	3000K								620€
+ honeycomb	3000K								860€

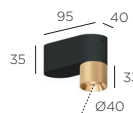

◆ Choose beam:  
M=medium 23°  
or W=wide 40°

# Audy-Duo 1 up Rounded

230V - driver included in base - (TRIAC/IGBT) dimmable  
1 x LED array 4,32W (LED incl.) - 500mA - 2700K (487lm) or 3000K (517lm) - CRI >95  
CEILING -

	COLOR LED	DIM	BASE brass RING black	BASE brass RING white	BASE black RING brass	BASE white RING brass	RETAIL PRICE VAT. EXCL.
	2700K		AYUP 2132◆	AYUP 2131◆	AYUP 2123◆	AYUP 2113◆	400€
	2700K						340€
	3000K		AYUP 3132◆	AYUP 3131◆	AYUP 3123◆	AYUP 3113◆	400€
	3000K						340€
+ honeycomb	2700K		AYUP 2132H◆	AYUP 2131H◆	AYUP 2123H◆	AYUP 2113H◆	410€
+ honeycomb	2700K						350€
+ honeycomb	3000K		AYUP 3132H◆	AYUP 3131H◆	AYUP 3123H◆	AYUP 3113H◆	410€
+ honeycomb	3000K						350€

gunmetal, bronze and nickel combinations on demand

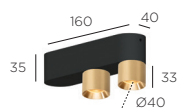

◆ Choose beam:  
M=medium 23°  
or W=wide 40°

# Audy-Duo 2 up Rounded

230V - driver included in base - (TRIAC/IGBT) dimmable  
2 x LED array 4,32W (LED incl.) - 500mA - 2700K (2 x 487lm) or 3000K (2 x 517lm) - CRI >95  
CEILING -

	COLOR LED	DIM	BASE brass RING black	BASE brass RING white	BASE black RING brass	BASE white RING brass	RETAIL PRICE VAT. EXCL.
	2700K		AYUP 2232◆	AYUP 2231◆	AYUP 2223◆	AYUP 2213◆	710€
	2700K						600€
	3000K		AYUP 3232◆	AYUP 3231◆	AYUP 3223◆	AYUP 3213◆	710€
	3000K						600€
+ honeycomb	2700K		AYUP 2232H◆	AYUP 2231H◆	AYUP 2223H◆	AYUP 2213H◆	730€
+ honeycomb	2700K						620€
+ honeycomb	3000K		AYUP 3232H◆	AYUP 3231H◆	AYUP 3223H◆	AYUP 3213H◆	730€
+ honeycomb	3000K						620€

gunmetal, bronze and nickel combinations on demand

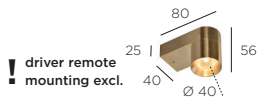

! driver remote mounting excl.

Choose beam:  
M=medium 23°  
or W=wide 40°

# Audy-Wall 1S

500mA - **required remote mounted driver see below**

1 x LED array 4,32W (LED incl.) - 500mA - 2700K (487lm) or 3000K (517lm) - CRI >95

WALL -

COLOR LED	FRAME brass	FRAME black	FRAME white	FRAME gunmetal	FRAME bronze	FRAME nickel	RETAIL PRICE VAT. EXCL.
2700K	ATWS 1273	ATWS 1272	ATWS 1271				420€
2700K				ATWS 1274	ATWS 1277	ATWS 1279	495€
3000K	ATWS 1303	ATWS 1302	ATWS 1301				420€
3000K				ATWS 1304	ATWS 1307	ATWS 1309	495€

## REQUIRED REMOTE MOUNTED DRIVER

DEVICE	DIM.	DRIVER	NET PRICE
1 x	LC (TRIAC/IGBT)	D 6WT500	16€
2 x	LC (TRIAC/IGBT)	D 10WT500	18€
1-4 x	PU (PUSH-DIM) + 1-10 (1-10V)	D 15WP*	25€
1-4 x	DA (DALI)	D 15WDA US*	28€
1-12 x	PU (PUSH-DIM) + DA (DALI) + 1-10 (1-10V)	D 40WDP*	57€

For warranty use only Trizo21® supplied LED drivers as mentioned.  
For all specs and techs about drivers, see [www.trizo21.com/drivers](http://www.trizo21.com/drivers)

driver remote mounting; driver does not fit through cutout hole of fixture  
\*110V-230V

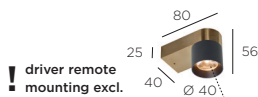

! driver remote mounting excl.

Choose beam:  
M=medium 23°  
or W=wide 40°

# Audy-Wall 1S Duo

500mA - **required remote mounted driver see below**

1 x LED array 4,32W (LED incl.) - 500mA - 2700K (487lm) or 3000K (517lm) - CRI >95

WALL -

COLOR LED	FRAME RING	FRAME brass	FRAME black	FRAME white	FRAME gunmetal	FRAME bronze	RETAIL PRICE VAT. EXCL.
2700K	brass RING		ATWS 1223	ATWS 1213			420€
2700K	black RING	ATWS 1232					420€
2700K	white RING	ATWS 1231					420€
2700K	gunmetal RING	ATWS 1234					435€
2700K	bronze RING	ATWS 1237					435€
2700K	brass RING				ATWS 1243	ATWS 1773	480€
3000K	brass RING		ATWS 1323	ATWS 1313			420€
3000K	black RING	ATWS 1332					420€
3000K	white RING	ATWS 1331					420€
3000K	gunmetal RING	ATWS 1334					435€
3000K	bronze RING	ATWS 1337					435€
3000K	brass RING				ATWS 1343	ATWS 1373	480€

## REQUIRED REMOTE MOUNTED DRIVER

DEVICE	DIM.	DRIVER	NET PRICE
1 x	LC (TRIAC/IGBT)	D 6WT500	16€
2 x	LC (TRIAC/IGBT)	D 10WT500	18€
1-4 x	PU (PUSH-DIM) + 1-10 (1-10V)	D 15WP*	25€
1-4 x	DA (DALI)	D 15WDA US*	28€
1-12 x	PU (PUSH-DIM) + DA (DALI) + 1-10 (1-10V)	D 40WDP*	57€

For warranty use only Trizo21® supplied LED drivers as mentioned.  
For all specs and techs about drivers, see [www.trizo21.com/drivers](http://www.trizo21.com/drivers)

driver remote mounting; driver does not fit through cutout hole of fixture  
\*110V-230V

! driver remote mounting excl.

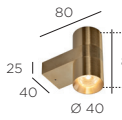

▲ Choose beam upper lightsource:  
M=medium 23° or W=wide 40°  
▼ Choose beam lower lightsource:  
M=medium 23° or W=wide 40°

# Audy-Wall 2S

500mA - **required remote mounted driver see below**

2 x LED array 4,32W (LED incl.) - 500mA - 2700K (2 x 487lm) or 3000K (2 x 517lm) - CRI >95

WALL -

COLOR LED	FRAME brass	FRAME black	FRAME white	FRAME gunmetal	FRAME bronze	FRAME nickel	RETAIL PRICE VAT. EXCL.
2700K	ATWD 2273 ▲▼	ATWD 2272 ▲▼	ATWD 2271 ▲▼				540€
2700K				ATWD 2274 ▲▼	ATWD 2277 ▲▼	ATWD 2279 ▲▼	635€
3000K	ATWD 2303 ▲▼	ATWD 2302 ▲▼	ATWD 2301 ▲▼				540€
3000K				ATWD 2304 ▲▼	ATWD 2307 ▲▼	ATWD 2309 ▲▼	635€

## REQUIRED REMOTE MOUNTED DRIVER

DEVICE	DIM.
1 x	LC (TRIAC/IGBT)
1-2 x	PU (PUSH-DIM) + 1-10 (1-10V)
1-2 x	DA (DALI)
1-4 x	PU (PUSH-DIM) + DA (DALI) + 1-10 (1-10V)

DRIVER	NET PRICE
D 10WT500	18€
D 15WP*	25€
D 15WDA US*	28€
D 40WDP*	57€

For warranty use only Trizo21® supplied LED drivers as mentioned.  
For all specs and techs about drivers, see [www.trizo21.com/drivers](http://www.trizo21.com/drivers)

driver remote mounting: driver does not fit through cutout hole of fixture  
\*110V-230V

! driver remote mounting excl.

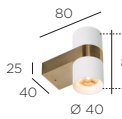

▲ Choose beam upper lightsource:  
M=medium 23° or W=wide 40°  
▼ Choose beam lower lightsource:  
M=medium 23° or W=wide 40°

# Audy-Wall 2S Duo

500mA - **required remote mounted driver see below**

2 x LED array 4,32W (LED incl.) - 500mA - 2700K (2 x 487lm) or 3000K (2 x 517lm) - CRI >95

WALL -

COLOR LED	RING	FRAME	FRAME brass	FRAME black	FRAME white	FRAME gunmetal	FRAME bronze	RETAIL PRICE VAT. EXCL.
2700K				ATWD 2223 ▲▼	ATWD 2213 ▲▼			540€
2700K			ATWD 2232 ▲▼					540€
2700K			ATWD 2231 ▲▼					540€
2700K			ATWD 2234 ▲▼					570€
2700K			ATWD 2237 ▲▼					570€
2700K						ATWD 2243 ▲▼	ATWD 2273 ▲▼	605€
3000K				ATWD 2323 ▲▼	ATWD 2313 ▲▼			540€
3000K			ATWD 2332 ▲▼					540€
3000K			ATWD 2331 ▲▼					540€
3000K			ATWD 2334 ▲▼					570€
3000K			ATWD 2337 ▲▼					570€
3000K						ATWD 2343 ▲▼	ATWD 2373 ▲▼	605€

## REQUIRED REMOTE MOUNTED DRIVER

DEVICE	DIM.
1 x	LC (TRIAC/IGBT)
1-2 x	PU (PUSH-DIM) + 1-10 (1-10V)
1-2 x	DA (DALI)
1-4 x	PU (PUSH-DIM) + DA (DALI) + 1-10 (1-10V)

DRIVER	NET PRICE
D 10WT500	18€
D 15WP*	25€
D 15WDA US*	28€
D 40WDP*	57€

For warranty use only Trizo21® supplied LED drivers as mentioned.  
For all specs and techs about drivers, see [www.trizo21.com/drivers](http://www.trizo21.com/drivers)

driver remote mounting: driver does not fit through cutout hole of fixture  
\*110V-230V

# AUSTERE-ELEMENTS

Design your own unique composition with our configurator:  
[www.elements-configurator.trizo21.com](http://www.elements-configurator.trizo21.com)

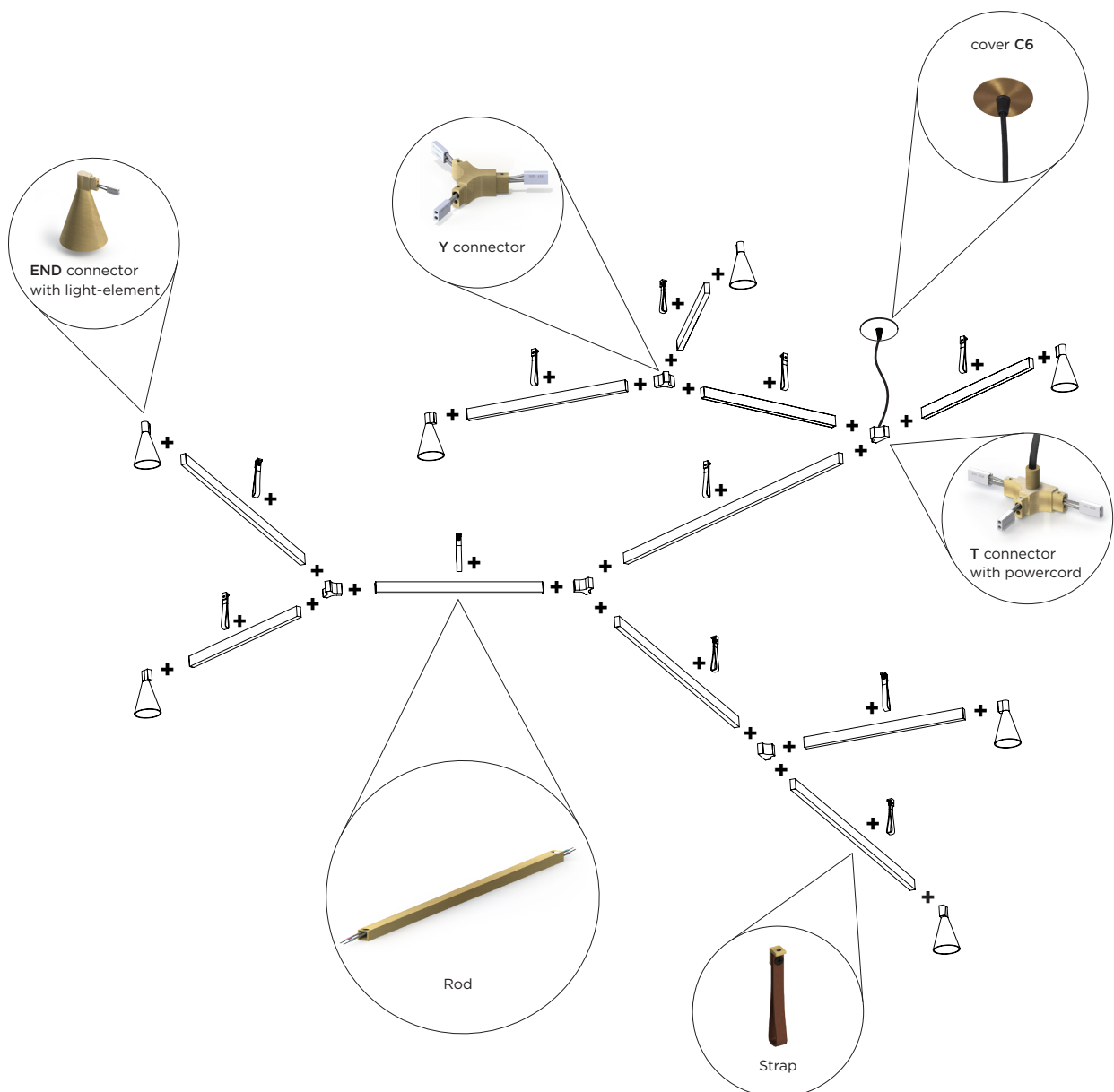

# Austere-Elements Configuration °1

350mA - **driver + base/cover/canopy required** see p.47  
 6 x LED array 6W (LED incl.) - 350mA - 6 x 634lm - 2700K - CRI >93  
 CEILING - IP50

FRAME brass  
 POWERCORD black  
 LEATHER oak

ELEM 1323

FRAME black  
 POWERCORD black  
 LEATHER black

ELEM 1222

FRAME brass  
 POWERCORD white  
 LEATHER oak

ELEM 1313

FRAME black  
 POWERCORD white  
 LEATHER black

ELEM 1212

RETAIL PRICE  
 VAT. EXCL.

| 3.815€

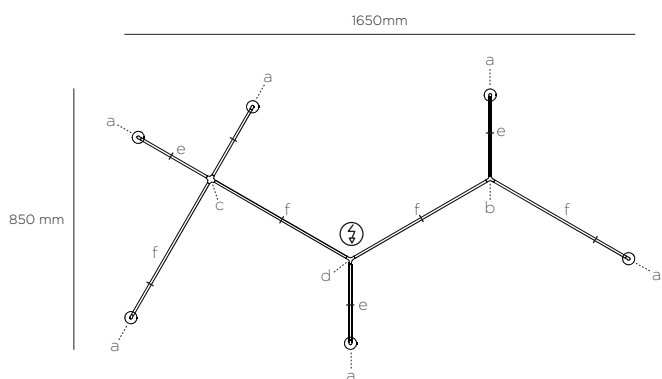

- a: 6x **END** connector with light-element
  - b: 1x **Y** connector
  - c: 1x **+** connector
  - d: 1x **Y** connector with powercord L250
  - e: 4x **Austere-Elements rods L250**
  - f: 4x **Austere-Elements rods L500**
  - 8x **Austere-Elements straps H93**
- (driver + base/cover/canopy excl. see p.47)

# Austere-Elements Configuration °2

350mA - **driver + base/cover/canopy required** see p.47  
 8 x LED array 6W (LED incl.) - 350mA - 8 x 634lm - 2700K - CRI >93  
 CEILING - IP50

FRAME brass  
 POWERCORD black  
 LEATHER oak

ELEM 2323

FRAME black  
 POWERCORD black  
 LEATHER black

ELEM 2222

FRAME brass  
 POWERCORD white  
 LEATHER oak

ELEM 2313

FRAME black  
 POWERCORD white  
 LEATHER black

ELEM 2212

RETAIL PRICE  
 VAT. EXCL.

| 5.245€

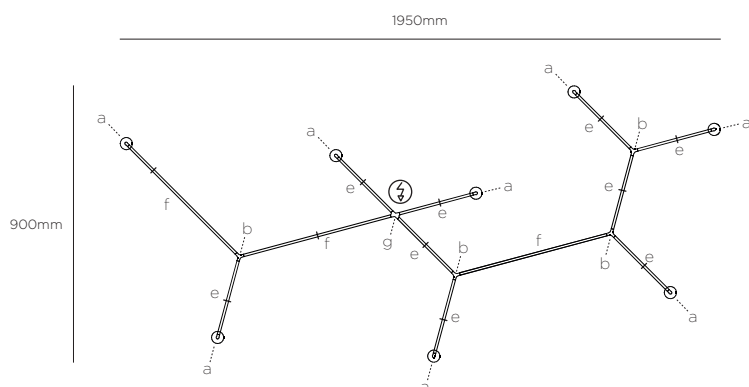

- a: 8x **END** connector with light-element
  - b: 4x **Y** connector
  - g: 1x **X** connector with powercord L250
  - e: 9x **Austere-Elements rods L250**
  - f: 3x **Austere-Elements rods L500**
  - 12x **Austere-Elements straps H93**
- (driver + base/cover/canopy excl. see p.47)

# Austere-Elements Configuration °3

350mA - **driver + base/cover/canopy required** see p.47  
 8 x LED array 6W (LED incl.) - 350mA - 8 x 634lm - 2700K - CRI >93  
 CEILING - IP50

FRAME brass  
 POWERCORD black  
 LEATHER oak

ELEM 3323

FRAME black  
 POWERCORD black  
 LEATHER black

ELEM 3222

FRAME brass  
 POWERCORD white  
 LEATHER oak

ELEM 3313

FRAME black  
 POWERCORD white  
 LEATHER black

ELEM 3212

RETAIL PRICE  
 VAT. EXCL.

| 5.480€

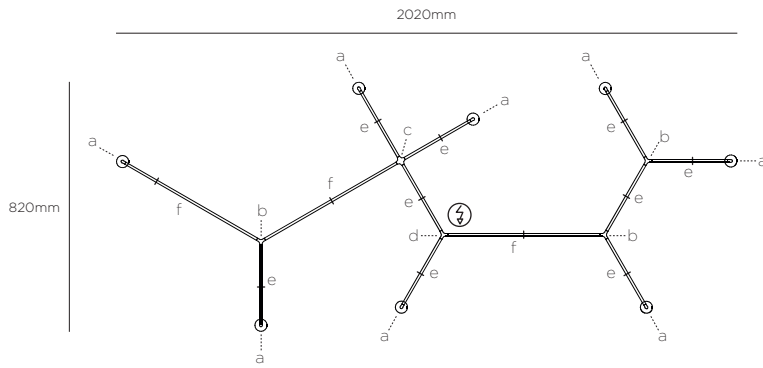

- a: 8x **END** connector with light-element
  - b: 3x **Y** connector
  - c: 1x **+** connector
  - d: 1x **Y** connector with powercord L250
  - e: 9x **Austere-Elements** rods L250
  - f: 3x **Austere-Elements** rods L500
  - 12x **Austere-Elements** straps H93
- (driver + base/cover/canopy excl. see p.47)

# Austere-Elements Configuration °4

350mA - **driver + base/cover/canopy required** see p.47  
 7 x LED array 6W (LED incl.) - 350mA - 7 x 634lm - 2700K - CRI >93  
 CEILING - IP50

FRAME brass  
 POWERCORD black  
 LEATHER oak

ELEM 4323

FRAME black  
 POWERCORD black  
 LEATHER black

ELEM 4222

FRAME brass  
 POWERCORD white  
 LEATHER oak

ELEM 4313

FRAME black  
 POWERCORD white  
 LEATHER black

ELEM 4212

RETAIL PRICE  
 VAT. EXCL.

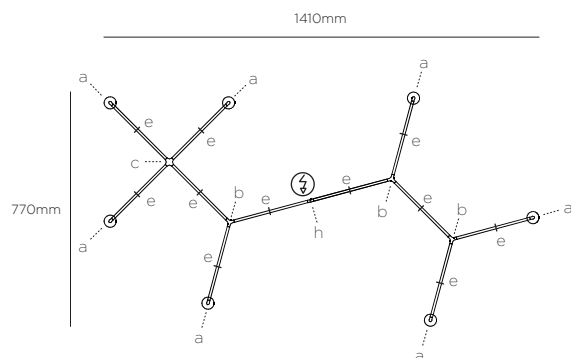

| 4.940€



- a: 7x **END** connector with light-element
  - b: 3x **Y** connector
  - c: 1x **+** connector
  - h: 1x **-** connector with powercord L500
  - e: 11x **Austere-Elements** rods L250
  - 11x **Austere-Elements** straps H93
- (driver + base/cover/canopy excl. see p.47)



# Austere-Elements Configuration °5

350mA - **driver + base/cover/canopy required** see p.47  
 9 x LED array 6W (LED incl.) - 350mA - 9 x 634lm - 2700K - CRI >93  
 CEILING -  IP50 

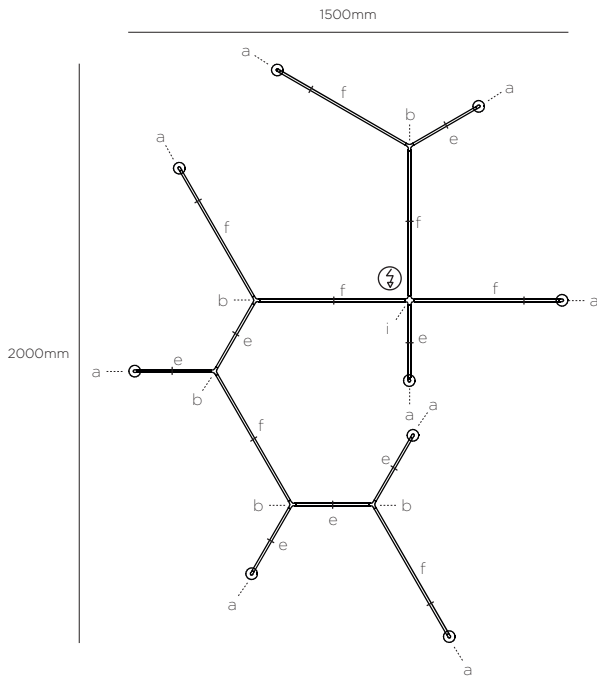

FRAME brass  
 POWERCORD black  
 LEATHER oak

ELEM 5323

FRAME black  
 POWERCORD black  
 LEATHER black

ELEM 5222

FRAME brass  
 POWERCORD white  
 LEATHER oak

ELEM 5313

FRAME black  
 POWERCORD white  
 LEATHER black



ELEM 5212

RETAIL PRICE  
 VAT. EXCL.

| 6.230€

- a: 9x **END** connector with light-element
  - b: 5x **Y** connector
  - i: 1x **+** connector with powercord L250
  - e: 7x **Austere-Elements** rods L250
  - f: 7x **Austere-Elements** rods L500
  - 14x **Austere-Elements** straps H93
- (driver + base/cover/canopy excl. see p.47)

# Austere-Elements Configuration °6

350mA - **driver + base/cover/canopy required** see p.47  
 8 x LED array 6W (LED incl.) - 350mA - 8 x 634lm - 2700K - CRI >93  
 CEILING -  IP50 

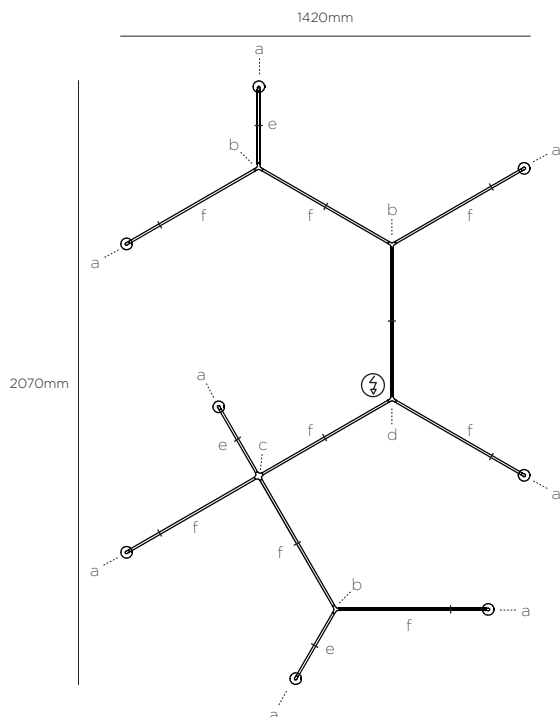

FRAME brass  
 POWERCORD black  
 LEATHER oak

ELEM 6323

FRAME black  
 POWERCORD black  
 LEATHER black

ELEM 6222

FRAME brass  
 POWERCORD white  
 LEATHER oak

ELEM 6313

FRAME black  
 POWERCORD white  
 LEATHER black

ELEM 6212

RETAIL PRICE  
 VAT. EXCL.

| 5.570€

- a: 8x **END** connector with light-element
  - b: 3x **Y** connector
  - c: 1x **+** connector
  - d: 1x **Y** connector with powercord L250
  - e: 3x **Austere-Elements** rods L250
  - f: 9x **Austere-Elements** rods L500
  - 12x **Austere-Elements** straps H93
- (driver + base/cover/canopy excl. see p.47)

# Austere-Elements Configuration °7

350mA - **driver + base/cover/canopy required** see p.47  
 7 x LED array 6W (LED incl.) - 350mA - 7 x 634lm - 2700K - CRI >93  
 CEILING - IP50

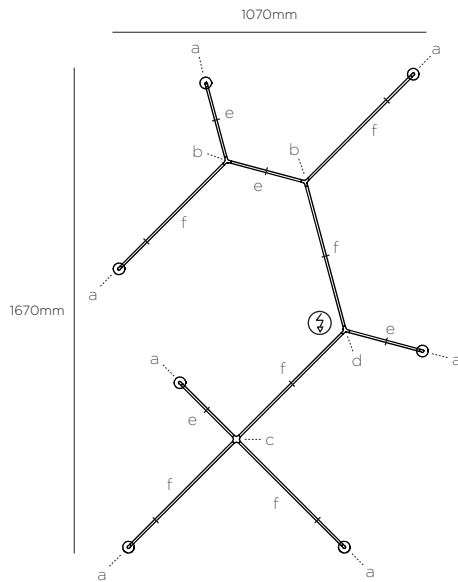

FRAME brass  
 POWERCORD black  
 LEATHER oak

ELEM 7323

FRAME black  
 POWERCORD black  
 LEATHER black

ELEM 7222

FRAME brass  
 POWERCORD white  
 LEATHER oak

ELEM 7313

FRAME black  
 POWERCORD white  
 LEATHER black

ELEM 7212

RETAIL PRICE  
 VAT. EXCL.

| 4.685€

- a: 7x **END** connector with light-element
  - b: 2x **Y** connector
  - c: 1x **+** connector
  - d: 1x **Y** connector with powercord L250
  - e: 4x **Austere-Elements** rods L250
  - f: 6x **Austere-Elements** rods L500
  - 10x **Austere-Elements** straps H93
- (driver + base/cover/canopy excl. see p.47)

# Austere-Elements Configuration °8

350mA - **driver + base/cover/canopy required** see p.47  
 9 x LED array 6W (LED incl.) - 350mA - 9 x 634lm - 2700K - CRI >93  
 CEILING - IP50

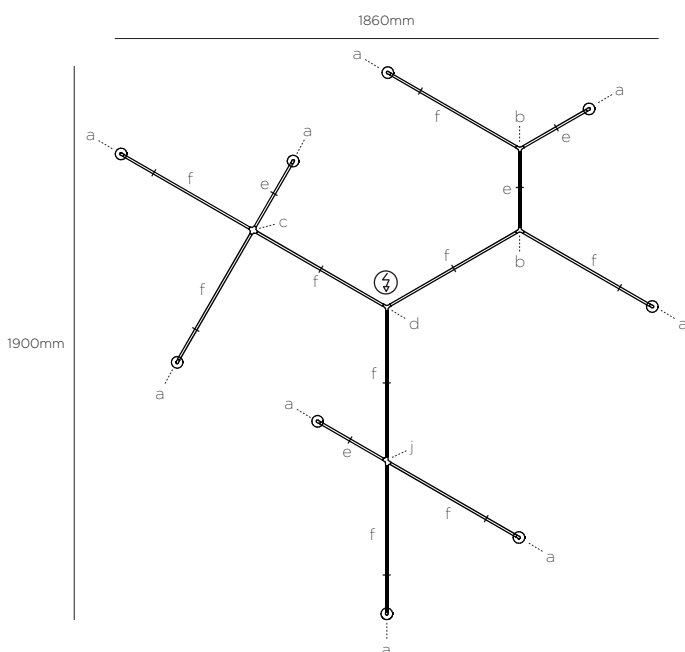

FRAME brass  
 POWERCORD black  
 LEATHER oak

ELEM 8323

FRAME black  
 POWERCORD black  
 LEATHER black

ELEM 8222

FRAME brass  
 POWERCORD white  
 LEATHER oak

ELEM 8313

FRAME black  
 POWERCORD white  
 LEATHER black

ELEM 8212

RETAIL PRICE  
 VAT. EXCL.

| 6.035€

- a: 9x **END** connector with light-element
  - b: 2x **Y** connector
  - c: 1x **+** connector
  - j: 1x **X** connector
  - d: 1x **Y** connector with powercord L250
  - e: 4x **Austere-Elements** rods L250
  - f: 9x **Austere-Elements** rods L500
  - 13x **Austere-Elements** straps H93
- (driver + base/cover/canopy excl. see p.47)

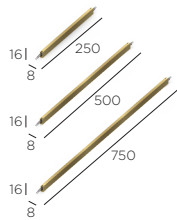

## Austere-Elements Rods

LENGTH	FRAME brass	FRAME black	RETAIL PRICE VAT. EXCL.
L 250	HEL <b>R</b> 2003	HEL <b>R</b> 2002	125€
L 500	HEL <b>R</b> 5003	HEL <b>R</b> 5002	140€
L 750	HEL <b>R</b> 7003	HEL <b>R</b> 7002	150€



## Austere-Elements Straps H93



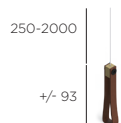







FRAME brass LEATHER oak	FRAME black LEATHER oak	FRAME brass LEATHER black	FRAME black LEATHER black	RETAIL PRICE VAT. EXCL.
HEL <b>S</b> 0933	HEL <b>S</b> 0923	HEL <b>S</b> 0932	HEL <b>S</b> 0922	85€





## Austere-Elements Straps Steelcable











LENGTH	FRAME brass LEATHER oak STEELCABLE silver	FRAME black LEATHER oak STEELCABLE black	FRAME brass LEATHER black STEELCABLE silver	FRAME black LEATHER black STEELCABLE black	RETAIL PRICE VAT. EXCL.
L 250	HEL <b>S</b> 0033	HEL <b>S</b> 0023	HEL <b>S</b> 0032	HEL <b>S</b> 0022	140€
L 500	HEL <b>S</b> 0533	HEL <b>S</b> 0523	HEL <b>S</b> 0532	HEL <b>S</b> 0522	145€
L 1000	HEL <b>S</b> 1033	HEL <b>S</b> 1023	HEL <b>S</b> 1032	HEL <b>S</b> 1022	150€
L 2000	HEL <b>S</b> 2033	HEL <b>S</b> 2023	HEL <b>S</b> 2032	HEL <b>S</b> 2022	155€

# Austere-Elements connectors

	FRAME brass	FRAME black	RETAIL PRICE VAT. EXCL.		FRAME brass	FRAME black	RETAIL PRICE VAT. EXCL.
<b>END connector</b>					HEL <b>E</b> 0003	HEL <b>E</b> 0002	90€
<b>- connector</b>					HEL <b>-</b> 0003	HEL <b>-</b> 0002	130€
<b>+ connector</b>					HEL <b>+</b> 0003	HEL <b>+</b> 0002	170€
<b>Y connector</b>					HEL <b>Y</b> 0003	HEL <b>Y</b> 0002	170€
					HEL <b>T</b> 0003	HEL <b>T</b> 0002	165€
					HEL <b>X</b> 0003	HEL <b>X</b> 0002	175€
					HEL <b>90</b> 0003	HEL <b>90</b> 0002	160€
					HEL <b>120</b> 0003	HEL <b>120</b> 0002	160€

# Austere-Elements connectors with light-element

350mA - **driver + base/cover/canopy required** see p.47  
 1 x LED array 6W (LED incl.) - 350mA - 634lm - 2700K - CRI >93  
**CEILING** -   

	FRAME brass	FRAME black	RETAIL PRICE VAT. EXCL.		FRAME brass	FRAME black	RETAIL PRICE VAT. EXCL.
<b>END connector with light-element</b>					HELE L003	HELE L002	250€
<b>- connector with light-element</b>					HEL <b>-</b> L003	HEL <b>-</b> L002	295€
<b>+ connector with light-element</b>					HEL <b>+</b> L003	HEL <b>+</b> L002	330€
<b>Y connector with light-element</b>					HELY L003	HELY L002	330€
					HEL <b>T</b> L003	HEL <b>T</b> L002	325€
					HEL <b>X</b> L003	HEL <b>X</b> L002	325€
					HEL <b>90</b> L003	HEL <b>90</b> L002	320€
					HEL <b>120</b> L003	HEL <b>120</b> L002	320€

# Austere-Elements connectors with powercord

	POWERCORD LENGTH	FRAME brass POWERCORD black	FRAME black POWERCORD black	FRAME brass POWERCORD white	FRAME black POWERCORD white	RETAIL PRICE VAT. EXCL.
<b>END</b> connector with powercord						
 <p>250-2000   16   15</p>	L 250	HECE 0023	HECE 0022	HECE 0013	HECE 0012	150€
	L 500	HECE 0523	HECE 0522	HECE 0513	HECE 0512	155€
	L 1000	HECE 0123	HECE 0122	HECE 0113	HECE 0112	160€
	L 2000	HECE 0223	HECE 0222	HECE 0213	HECE 0212	170€
<b>-</b> connector with powercord						
 <p>250-2000   16   15</p>	L 250	HEC- 0023	HEC- 0022	HEC- 0013	HEC- 0012	200€
	L 500	HEC- 0523	HEC- 0522	HEC- 0513	HEC- 0512	205€
	L 1000	HEC- 0123	HEC- 0122	HEC- 0113	HEC- 0112	210€
	L 2000	HEC- 0223	HEC- 0222	HEC- 0213	HEC- 0212	220€
<b>+</b> connector with powercord						
 <p>250-2000   16   15</p>	L 250	HEC+ 0023	HEC+ 0022	HEC+ 0013	HEC+ 0012	235€
	L 500	HEC+ 0523	HEC+ 0522	HEC+ 0513	HEC+ 0512	240€
	L 1000	HEC+ 0123	HEC+ 0122	HEC+ 0113	HEC+ 0112	245€
	L 2000	HEC+ 0223	HEC+ 0222	HEC+ 0213	HEC+ 0212	255€
<b>Y</b> connector with powercord						
 <p>250-2000   16   15</p>	L 250	HECY 0023	HECY 0022	HECY 0013	HECY 0012	235€
	L 500	HECY 0523	HECY 0522	HECY 0513	HECY 0512	240€
	L 1000	HECY 0123	HECY 0122	HECY 0113	HECY 0112	245€
	L 2000	HECY 0223	HECY 0222	HECY 0213	HECY 0212	255€
<b>T</b> connector with powercord						
 <p>250-2000   16   15</p>	L 250	HECT 0023	HECT 0022	HECT 0013	HECT 0012	225€
	L 500	HECT 0523	HECT 0522	HECT 0513	HECT 0512	230€
	L 1000	HECT 0123	HECT 0122	HECT 0113	HECT 0112	235€
	L 2000	HECT 0223	HECT 0222	HECT 0213	HECT 0212	245€
<b>X</b> connector with powercord						
 <p>250-2000   16   15</p>	L 250	HECX 0023	HECX 0022	HECX 0013	HECX 0012	240€
	L 500	HECX 0523	HECX 0522	HECX 0513	HECX 0512	245€
	L 1000	HECX 0123	HECX 0122	HECX 0113	HECX 0112	250€
	L 2000	HECX 0223	HECX 0222	HECX 0213	HECX 0212	260€
<b>90°</b> connector with powercord						
 <p>250-2000   16   15   90°</p>	L 250	HEC90 0023	HEC90 0022	HEC90 0013	HEC90 0012	220€
	L 500	HEC90 0523	HEC90 0522	HEC90 0513	HEC90 0512	225€
	L 1000	HEC90 0123	HEC90 0122	HEC90 0113	HEC90 0112	230€
	L 2000	HEC90 0223	HEC90 0222	HEC90 0213	HEC90 0212	240€
<b>120°</b> connector with powercord						
 <p>250-2000   16   15   120°</p>	L 250	HEC120 0023	HEC120 0022	HEC120 0013	HEC120 0012	220€
	L 500	HEC120 0523	HEC120 0522	HEC120 0513	HEC120 0512	225€
	L 1000	HEC120 0123	HEC120 0122	HEC120 0113	HEC120 0112	230€
	L 2000	HEC120 0223	HEC120 0222	HEC120 0213	HEC120 0212	240€

# Austere-Elements connectors with light-element & powercord

350mA - **driver + base/cover/canopy required** see p.47  
 1 x LED array 6W (LED incl.) - 350mA - 634lm - 2700K - CRI >93  
**CEILING** -

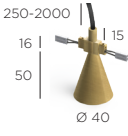
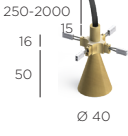
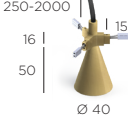
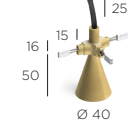
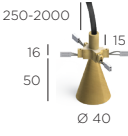
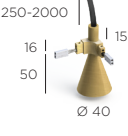
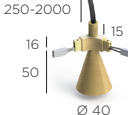
	POWERCORD LENGTH	FRAME brass POWERCORD black	FRAME black POWERCORD black	FRAME brass POWERCORD white	FRAME black POWERCORD white	RETAIL PRICE VAT. EXCL.
<b>-</b> connector with light-element & powercord						
 <p>250-2000 16   15 50 Ø 40</p>	L 250	HEC- L023	HEC- L022	HEC- L013	HEC- L012	355€
	L 500	HEC- L523	HEC- L522	HEC- L513	HEC- L512	360€
	L 1000	HEC- L123	HEC- L122	HEC- L113	HEC- L112	365€
	L 2000	HEC- L223	HEC- L222	HEC- L213	HEC- L212	375€
<b>+</b> connector with light-element & powercord						
 <p>250-2000 16   15 50 Ø 40</p>	L 250	HEC+ L023	HEC+ L022	HEC+ L013	HEC+ L012	400€
	L 500	HEC+ L523	HEC+ L522	HEC+ L513	HEC+ L512	405€
	L 1000	HEC+ L123	HEC+ L122	HEC+ L113	HEC+ L112	410€
	L 2000	HEC+ L223	HEC+ L222	HEC+ L213	HEC+ L212	420€
<b>Y</b> connector with light-element & powercord						
 <p>250-2000 16   15 50 Ø 40</p>	L 250	HECY L023	HECY L022	HECY L013	HECY L012	400€
	L 500	HECY L523	HECY L522	HECY L513	HECY L512	405€
	L 1000	HECY L123	HECY L122	HECY L113	HECY L112	410€
	L 2000	HECY L223	HECY L222	HECY L213	HECY L212	420€
<b>T</b> connector with light-element & powercord						
 <p>250-2000 16   15 50 Ø 40</p>	L 250	HECT L023	HECT L022	HECT L013	HECT L012	395€
	L 500	HECT L523	HECT L522	HECT L513	HECT L512	400€
	L 1000	HECT L123	HECT L122	HECT L113	HECT L112	405€
	L 2000	HECT L223	HECT L222	HECT L213	HECT L212	415€
<b>X</b> connector with light-element & powercord						
 <p>250-2000 16   15 50 Ø 40</p>	L 250	HECX L023	HECX L022	HECX L013	HECX L012	405€
	L 500	HECX L523	HECX L522	HECX L513	HECX L512	410€
	L 1000	HECX L123	HECX L122	HECX L113	HECX L112	415€
	L 2000	HECX L223	HECX L222	HECX L213	HECX L212	425€
<b>90°</b> connector with light-element & powercord						
 <p>250-2000 16   15 50 Ø 40</p>	L 250	HEC90 L023	HEC90 L022	HEC90 L013	HEC90 L012	385€
	L 500	HEC90 L523	HEC90 L522	HEC90 L513	HEC90 L512	390€
	L 1000	HEC90 L123	HEC90 L122	HEC90 L113	HEC90 L112	395€
	L 2000	HEC90 L223	HEC90 L222	HEC90 L213	HEC90 L212	405€
<b>120°</b> connector with light-element & powercord						
 <p>250-2000 16   15 50 Ø 40</p>	L 250	HEC120 L023	HEC120 L022	HEC120 L013	HEC120 L012	385€
	L 500	HEC120 L523	HEC120 L522	HEC120 L513	HEC120 L512	390€
	L 1000	HEC120 L123	HEC120 L122	HEC120 L113	HEC120 L112	395€
	L 2000	HEC120 L223	HEC120 L222	HEC120 L213	HEC120 L212	405€

### REQUIRED COVER/CANOPY for Austere-Elements with REMOTE MOUNTED DRIVER

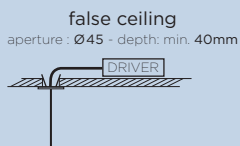

brass		21CO 0003	85€
black		21CO 0002	85€
white		21CO 0001	85€

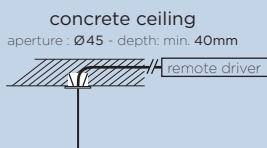

brass		21CO 0013	105€
black		21CO 0012	105€
white		21CO 0011	105€

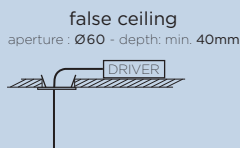

black		21CO 2000	40€
white		21CO 1000	40€

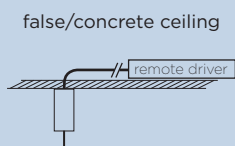
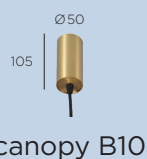

brass		21CP 3003	280€
black		21CP 2002	280€
white		21CP 1001	280€

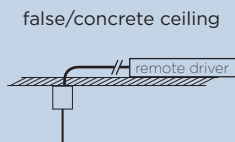

black		21CP 5000	165€
white		21CP 4000	165€

### REQUIRED REMOTE MOUNTED DRIVER for Austere-Elements

DEVICE	DIM.	DRIVER	NET PRICE
2-7 x	NO (non-dimmable)	N 50W*	29€
3-12 x	NO (non-dimmable)	N 80W*	33€
3-12 x	PU (PUSH-DIM) + 1-10 (1-10V)	D 80WP*	45€
3-12 x	PU (PUSH-DIM) + DA (DALI)	D 80WD*	51€

\*driver only fits through cutout hole of fixture with C6 and C9, min. depth for driver in false ceiling: 280mm  
For warranty use only Trizo21® supplied LED drivers as mentioned. For all specs and techs about drivers, see [www.trizo21.com/drivers](http://www.trizo21.com/drivers)

### REQUIRED BASE (DRIVER INCL.) for SURFACE MOUNTING Austere-Elements

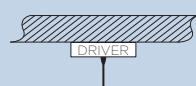

black		1-10 PU DA	BCDP 2402	320€
white		1-10 PU DA	BCDP 2401	320€

110V-230V - driver included in base  
+ casambi possible  
Min. 2 light-elements  
Max. 6 light-elements

optional: casambi | D CAS | 95€ (NET PRICE)

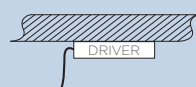
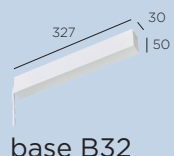

black		NO	BNDN 0822	455€
white		NO	BNDN 0811	455€

230V - driver included in base  
Min. 3 light-elements  
Max. 12 light-elements

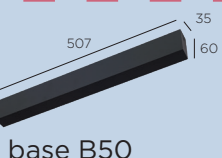

black		1-10 PU	BDFU 0822	555€
white		1-10 PU	BDFU 0811	555€
black		DA PU	BDDA 0822	590€
white		DA PU	BDDA 0811	590€

230V - driver included in base  
+ casambi possible  
Min. 3 light-elements  
Max. 12 light-elements

optional: casambi | D CAS | 95€ (NET PRICE)

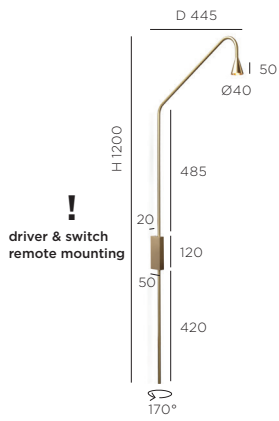

# Austere-Wall built-in

350mA - **required remote mounted driver see below**  
 1 x LED array 6W (LED incl.) - 350mA - 634lm - 2700K - CRI >93  
 WALL -

FRAME brass	FRAME black	FRAME white	FRAME gunmetal	FRAME bronze	FRAME nickel	RETAIL PRICE VAT. EXCL.
●	●	○	●	●	○	
HVWB 1003	HVWB 1002	HVWB 1001	HVWB 1004	HVWB 1007	HVWB 1009	715€
						850€

## REQUIRED REMOTE MOUNTED DRIVER

DEVICE	DIM.	DRIVER	NET PRICE
1 x	LC (TRIAC/IGBT)	D 6WT	14€
2 x	LC (TRIAC/IGBT)	D 18WT	22€
1-2 x	PU (PUSH-DIM) + I-10 (1-10V)	D 15WP*	25€
1-2 x	DA (DALI)	D 15WDA EU	28€
1-2 x	DA (DALI)	D 15WDA US*	28€
2-6 x	PU (PUSH-DIM) + DA (DALI) + I-10 (1-10V)	D 40WDP*	57€

For warranty use only Trizo21® supplied LED drivers as mentioned.  
 For all specs and techs about drivers, see [www.trizo21.com/drivers](http://www.trizo21.com/drivers)

driver remote mounting: driver does not fit through cutout hole of fixture  
 \*110V-230V

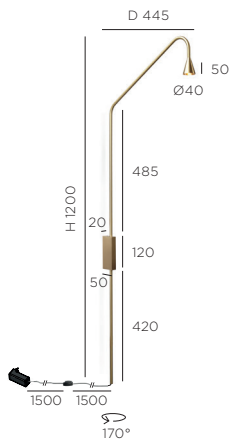

# Austere-Wall plug

100V-240V - plugdriver with PU (PUSH-DIM) button dimmer on cable  
 1 x LED array 6W (LED incl.) - 350mA - 634lm - 2700K - CRI >93  
 WALL -

FRAME brass	FRAME black	FRAME white	FRAME gunmetal	FRAME bronze	FRAME nickel	RETAIL PRICE VAT. EXCL.
●	●	○	●	●	○	
EU plug	EU plug	EU plug	EU plug	EU plug	EU plug	715€
EU plug	EU plug	EU plug	EU plug	EU plug	EU plug	850€
UK plug	UK plug	UK plug	UK plug	UK plug	UK plug	715€
UK plug	UK plug	UK plug	UK plug	UK plug	UK plug	850€
US plug	US plug	US plug	US plug	US plug	US plug	715€
US plug	US plug	US plug	US plug	US plug	US plug	850€
AU plug	AU plug	AU plug	AU plug	AU plug	AU plug	715€
AU plug	AU plug	AU plug	AU plug	AU plug	AU plug	850€



# Austere-Wall push built-in

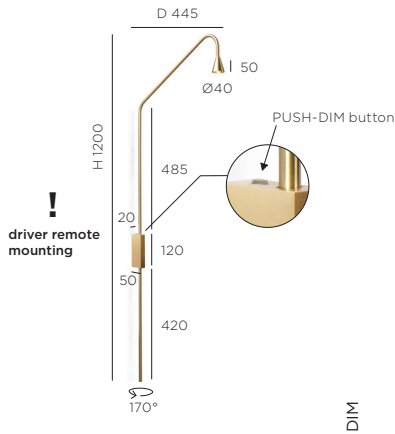

350mA - **required remote mounted driver see below** - **PU (PUSH-DIM) button on base**  
 1 x LED array 6W (LED incl.) - 350mA - 634lm - 2700K - CRI >93  
**WALL** -

DIM	FRAME brass	FRAME black	FRAME white	FRAME gunmetal	FRAME bronze	FRAME nickel	RETAIL PRICE VAT. EXCL.
 	HVWT 1003	HVWT 1002	HVWT 1001	HVWT 1004	HVWT 1007	HVWT 1009	800€ 935€

## REQUIRED REMOTE MOUNTED DRIVER

DEVICE	DIM.	DRIVER	NET PRICE
1 x	(PUSH-DIM)	D 15WPLV*	32€

For warranty use only Trizo21® supplied LED drivers as mentioned.  
 For all specs and techs about drivers, see [www.trizo21.com/drivers](http://www.trizo21.com/drivers)

driver remote mounting: driver does not fit through cutout hole of fixture  
 \*110V-230V

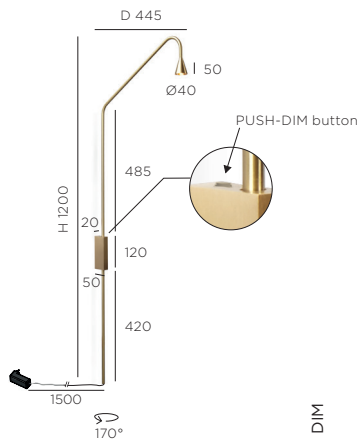

# Austere-Wall push plug

100V-240V - **plugdriver** - **PU (PUSH-DIM) button on base**  
 1 x LED array 6W (LED incl.) - 350mA - 634lm - 2700K - CRI >93  
**WALL** -

	DIM	FRAME brass	FRAME black	FRAME white	FRAME gunmetal	FRAME bronze	FRAME nickel	RETAIL PRICE VAT. EXCL.
EU plug		HVWT 1003EU	HVWT 1002EU	HVWT 1001EU	HVWT 1004EU	HVWT 1007EU	HVWT 1009EU	800€ 935€
EU plug								
UK plug		HVWT 1003UK	HVWT 1002UK	HVWT 1001UK	HVWT 1004UK	HVWT 1007UK	HVWT 1009UK	800€ 935€
UK plug								
US plug		HVWT 1003US	HVWT 1002US	HVWT 1001US	HVWT 1004US	HVWT 1007US	HVWT 1009US	800€ 935€
US plug								
AU plug		HVWT 1003AU	HVWT 1002AU	HVWT 1001AU	HVWT 1004AU	HVWT 1007AU	HVWT 1009AU	800€ 935€
AU plug								



# Bily 16 up

230V - driver included in base - LC (TRIAC/IGBT) dimmable  
 1 x LED array 11W (LED incl.) - 350mA - 1125lm - 2700K - CRI >97  
 CEILING -

	DIM	FRAME black	FRAME white	FRAME bronze	FRAME gold	FRAME alu	RETAIL PRICE VAT. EXCL.
silver LED HOLDER		BIUP 1620	BIUP 1610	BIUP 1670	BIUP 1680	BIUP 1690	505€
gold LED HOLDER		BIUP 1628	BIUP 1618	BIUP 1678	BIUP 1688	BIUP 1698	515€

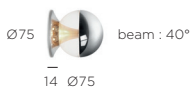

# Bouly W/C

350mA - required remote mounted driver see below  
 1 x 4 LED 0.96W (LED incl.) - 350mA - 456lm - 2700K - CRI >93  
 depth for driver in ceiling : min. 75 mm  
 WALL & CEILING -

	FRAME black	FRAME white	FRAME grey	FRAME chrome	RETAIL PRICE VAT. EXCL.
	BOWW 1002	BOWW 1001	BOWW 1003	BOWW 1009	385€ 425€

## REQUIRED REMOTE MOUNTED DRIVER

DEVICE	DIM.	DRIVER	NET PRICE
1 x	NO (non-dimmable)	N 5W	11€
1 x	C (IGBT)	D 6WI	13€
1 x	PU (PUSH-DIM) +	D 6WP	14€
1-3 x	PU (PUSH-DIM) +	D 15WP*	25€
1-3 x	DA (DALI)	D 15WDA EU	28€
1-3 x	DA (DALI)	D 15WDA US*	28€
2-8 x	PU (PUSH-DIM) + DA (DALI) +	D 40WDP*	57€

For warranty use only Trizo21® supplied LED drivers as mentioned.  
 For all specs and techs about drivers, see [www.trizo21.com/drivers](http://www.trizo21.com/drivers)

driver remote mounting: driver does not fit through cutout hole of fixture  
 \*110V-230V



# Bouly W/C D+B

230V - driver included in base - non-dimmable  
 1 x 4 LED 0.96W (LED incl.) - 350mA - 456lm - 2700K - CRI >93  
 WALL & CEILING -

	FRAME black	FRAME white	FRAME grey	FRAME chrome	RETAIL PRICE VAT. EXCL.
	BOWW 1102	BOWW 1101	BOWW 1103	BOWW 1109	460€ 510€



# Code 1 GU10

230V - GU10 - 1 x QPAR16 max. 50W or 1 x GU10 LED  
**Bulb excluded - CEILING -**

VOLT	FRAME black	FRAME white	FRAME alu	FRAME bronze	FRAME chrome	RETAIL PRICE VAT. EXCL.
230V	CODE 2001	CODE 1001				160€
230V			CODE 3001	CODE 7001		175€
230V					CODE 9001	205€

OPTIONAL COVER FOR CODE 1



ACDE 2010	ACDE 1010				40€
		ACDE 3010	ACDE 7010		42€
				ACDE 9010	50€



- ◆ Choose beam:  
 N=narrow 10° or  
 M=medium 25° or  
 W=wide 40°

# Code 1 LED

230V - driver included in base - **NO** (non-dimmable) or **C** (IGBT) dimmable  
 1 x 4 LED 0.96W (LED incl.) - 350mA - 456lm - 2700K - CRI >93  
**CEILING -**

DIM	FRAME black	FRAME white	FRAME alu	FRAME bronze	FRAME chrome	RETAIL PRICE VAT. EXCL.
<b>NO</b>	CODE 2105◆	CODE 1105◆				355€
<b>NO</b>			CODE 3105◆	CODE 7105◆		370€
<b>NO</b>					CODE 9105◆	405€
<b>C</b>	CODE 2405◆	CODE 1605◆				365€
<b>C</b>			CODE 3605◆	CODE 7605◆		380€
<b>C</b>					CODE 9605◆	415€

OPTIONAL COVER FOR CODE 1 LED



ACDE 2010	ACDE 1010				40€
		ACDE 3010	ACDE 7010		42€
				ACDE 9010	50€



# Code 2 GU10

230V - GU10 - 2 x QPAR16 max. 50W or 2 x GU10 LED  
**Bulbs excluded - CEILING -**

	FRAME black	FRAME white	FRAME alu	FRAME bronze	FRAME chrome	RETAIL PRICE VAT. EXCL.
	CODE 2002	CODE 1002	CODE 3002	CODE 7002	CODE 9002	195€ 220€ 275€

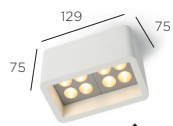

◆ Choose beam:  
 N=narrow 10° or  
 M=medium 25° or  
 W=wide 40°

# Code 2 LED

230V - driver included in base - (TRIAC/IGBT) dimmable  
 1 x 8 LED 0.96W (LED incl.) - 350mA - 912lm - 2700K - CRI >93  
**CEILING -**

	FRAME black	FRAME white	FRAME alu	FRAME bronze	FRAME chrome	RETAIL PRICE VAT. EXCL.
	CODE 2207◆	CODE 1207◆	CODE 3207◆	CODE 7207◆	CODE 9207◆	585€ 605€ 660€

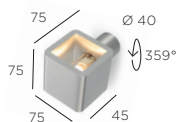

# Code W G9

230V G9 - 1 x HALO QT14 max. 60W or 1 x G9 LED (max. Ø19, max. L 62mm)  
**Bulb excluded - WALL -**

	FRAME black	FRAME white	FRAME alu	FRAME bronze	FRAME chrome	RETAIL PRICE VAT. EXCL.
230V - G9 HALO	CODE 2005	CODE 1005	CODE 3005	CODE 7005	CODE 9005	170€ 180€ 225€
230V - G9 LED	CODE L2005	CODE L1005	CODE L3005	CODE L7005	CODE L9005	170€ 180€ 225€
	ACDE 2005	ACDE 1005	ACDE 3005	ACDE 7005	ACDE 9005	40€ 42€ 50€



OPTIONAL COVER FOR CODE W

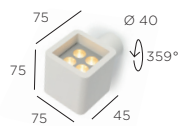

! driver remote mounting excl. driver does not fit through cutout hole of fixture

◆ Choose beam:  
 N=narrow 10° or  
 M=medium 25° or  
 W=wide 40°

# Code W LED

350mA - **required remote mounted driver see below**

1 lighting side : 1 x 4 LED 0.96W (LED incl.) - 350mA - 456lm - 2700K - CRI >93  
 2 lighting sides : 2 x 4 LED 0.96W (LED incl.) - 350mA - 2 x 456lm - 2700K - CRI >93  
 WALL - CE

	FRAME black	FRAME white	FRAME alu	FRAME bronze	FRAME chrome	RETAIL PRICE VAT. EXCL.
1 side	CODE 2555◆	CODE 1555◆				355€
2 sides	CODE 2666◆	CODE 1666◆				550€
1 side			CODE 3555◆	CODE 7555◆		375€
2 sides			CODE 3666◆	CODE 7666◆		570€
1 side					CODE 9555◆	415€
2 sides					CODE 9666◆	610€



OPTIONAL COVER FOR CODE W LED

ACDE 2005	ACDE 1005				40€
		ACDE 3005	ACDE 7005		42€
				ACDE 9005	50€

## REQUIRED REMOTE MOUNTED DRIVER

DEVICE	DIM.	DRIVER	NET PRICE
1 x 1 side	NO (non-dimmable)	N 5W ***	11€
1 x 1 side	C (IGBT)	D 6WI ***	13€
1 x 1 side	PU (PUSH-DIM) + I-10 (1-10V)	D 6WP ***	14€
1-2 x 1 side	NO (non-dimmable)	N 12W** ***	23€
2 x 1 side	LC (TRIAC/IGBT)	D 10WT ***	18€
1-3 x 1 side	PU (PUSH-DIM) + I-10 (1-10V)	D 15WP* ***	25€
1-3 x 1 side	DA (DALI)	D 15WDA EU ***	28€
1-3 x 1 side	DA (DALI)	D 15WDA US***	28€
2-8 x 1 side	PU (PUSH-DIM) + DA (DALI) + I-10 (1-10V)	D 40WDP* ***	57€
1 x 2 sides	NO (non-dimmable)	N 12W** ***	23€
1 x 2 sides	LC (TRIAC/IGBT)	D 10WT ***	18€
1 x 2 sides	PU (PUSH-DIM) + I-10 (1-10V)	D 15WP* ***	25€
1 x 2 sides	DA (DALI)	D 15WDA* ***	28€
1-4 x 2 sides	PU (PUSH-DIM) + DA (DALI) + I-10 (1-10V)	D 40WDP* ***	57€

For warranty use only Trizo21<sup>®</sup> supplied LED drivers as mentioned.  
 For all specs and techs about drivers, see [www.trizo21.com/drivers](http://www.trizo21.com/drivers)

driver remote mounting: driver does not fit through cutout hole of fixture  
 \*110V-230V \*\*IP65  
 \*\*\*driver fits behind optional cover for CODE W LED



# Kwa-Kwa 1F Round

12V - transformer excluded

G53 - 1 x R111 HALO max. 75W or R111 LED

Bulb excluded - WALL & CEILING ( \*only CEILING ) - CE

FLEX LENGTH	FRAME alu	RETAIL PRICE VAT. EXCL.
L 200	21IN 3201	170€
L 400	21IN 3241	175€
L 750*	21IN 3271*	185€
L 1000*	21IN 3261*	195€

OPTIONAL COVER KWA-KWA 1F ROUND

21AC 3200	42€
-----------	-----



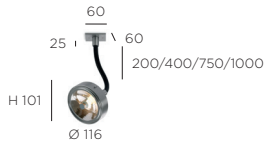

# Kwa-Kwa 1F Square

12V - transformer excluded

G53 - 1 x R111 HALO max. 75W or R111 LED

Bulb excluded - WALL & CEILING ( \*only CEILING ) -

FLEX LENGTH	FRAME alu	RETAIL PRICE VAT. EXCL.
L 200	21IN 4201	175€
L 400	21IN 4241	180€
L 750*	21IN 4271*	190€
L 1000*	21IN 4261*	200€

OPTIONAL COVER KWA-KWA 1F SQUARE

21AC 3203	42€
-----------	-----



# Kwa-Kwa 1F +B Round

12V - transformer excluded

G53 - 1 x R111 HALO max. 75W or R111 LED

Bulb excluded - WALL & CEILING ( \*only CEILING ) -

FLEX LENGTH	FRAME alu	RETAIL PRICE VAT. EXCL.
L 200	21SO 3201	190€
L 400	21SO 3241	200€
L 750*	21SO 3271*	210€
L 1000*	21SO 3251*	220€

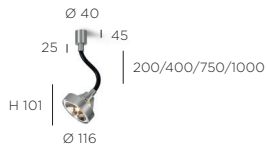

# Kwa-Kwa 1FT Rounded LED

230V - transformer included in base - (IGBT) dimmable

G53 - 1 x R111 LED max. 60W

LED bulb excluded - WALL & CEILING ( \*only CEILING ) -

FLEX LENGTH	FRAME alu	RETAIL PRICE VAT. EXCL.
L 200	21SO L3314	335€
L 400	21SO L3343	340€
L 750*	21SO L3373*	350€
L 1000*	21SO L3353*	360€

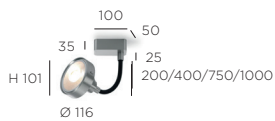

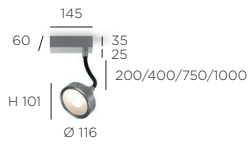

# Kwa-Kwa 1FT Rectangular LED

230V - transformer included in base - **LC** (TRIAC/IGBT) dimmable  
 G53 - 1 x R111 LED max. 60W - **LED bulb excluded** - WALL & CEILING ( \*only CEILING ) -

	FLEX LENGTH	FRAME alu	RETAIL PRICE VAT. EXCL.
	L 200	21SO L3214	315€
	L 400	21SO L3243	325€
	L 750*	21SO L3273*	335€
	L 1000*	21SO L3253*	340€

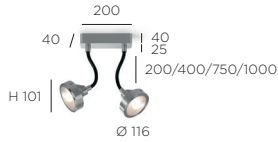

# Kwa-Kwa 2FT Rounded LED

230V - transformer included in base - **LC** (TRIAC/IGBT) dimmable  
 G53 - 2 x R111 LED max. 45W - **LED bulbs excluded** - WALL & CEILING ( \*only CEILING ) -

	FLEX LENGTH	FRAME alu	RETAIL PRICE VAT. EXCL.
	L 200	21SO L3402	500€
	L 400	21SO L3442	515€
	L 750*	21SO L3472*	535€
	L 1000*	21SO L3452*	560€

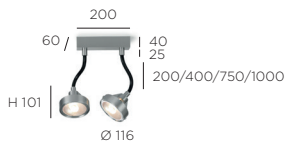

# Kwa-Kwa 2FT Rectangular LED

230V - transformer included in base - **LC** (TRIAC/IGBT) dimmable  
 G53 - 2 x R111 LED max. 45W - **LED bulbs excluded** - WALL & CEILING ( \*only CEILING ) -

	FLEX LENGTH	FRAME alu	RETAIL PRICE VAT. EXCL.
	L 200	21SO L3202	475€
	L 400	21SO L3242	485€
	L 750*	21SO L3272*	510€
	L 1000*	21SO L3252*	530€

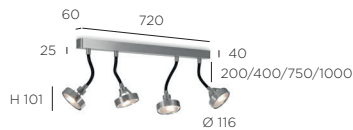

# Kwa-Kwa 4FT Rounded LED

230V - transformer included in base - **LC** (TRIAC/IGBT) dimmable  
 G53 - 4 x R111 LED max. 45W - **LED bulbs excluded** - WALL & CEILING ( \*only CEILING ) -

	FLEX LENGTH	FRAME alu	RETAIL PRICE VAT. EXCL.
	L 200	21SO L3404	1.090€
	L 400	21SO L3444	1.120€
	L 750*	21SO L3474*	1.160€
	L 1000*	21SO L3454*	1.215€

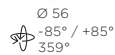
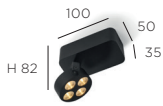

◆ Choose beam:  
 N=narrow 10° or  
 M=medium 25° or  
 W=wide 40°

# Mini-Pi 1 up

230V - driver included in base - **NO** (non-dimmable) or **C** (IGBT) dimmable  
 1 X 4 LED 0.96W (LED incl.) - 350mA - 456lm - 2700K - CRI >93  
 WALL & CEILING -

DIM	FRAME black	FRAME white	FRAME alu	FRAME bronze	RETAIL PRICE VAT. EXCL.
<b>NO</b>	MIPU 1225 ◆	MIPU 1115 ◆	MIPU 1995 ◆	MIPU 1775 ◆	355€
<b>C</b>	MIPU 1525 ◆	MIPU 1615 ◆	MIPU 1595 ◆	MIPU 1575 ◆	365€

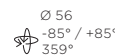

◆ Choose beam:  
 N=narrow 10° or  
 M=medium 25° or  
 W=wide 40°

# Mini-Pi 1 up Round

230V - driver included in base - **NO** (non-dimmable)  
 1 X 4 LED 0.96W (LED incl.) - 350mA - 456lm - 2700K - CRI >93  
 WALL & CEILING -

DIM	FRAME black	FRAME white	FRAME alu	FRAME bronze	RETAIL PRICE VAT. EXCL.
<b>NO</b>	MIPRU 1225 ◆	MIPRU 1115 ◆	MIPRU 1995 ◆	MIPRU 1775 ◆	355€

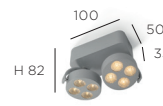

◆ Choose beam:  
 N=narrow 10° or  
 M=medium 25° or  
 W=wide 40°

# Mini-Pi 2 up

230V - driver included in base - **LC** (TRIAC/IGBT) dimmable  
 2 x 4 LED 0.96W (LED incl.) - 350mA - 2 x 456lm - 2700K - CRI >93  
 WALL & CEILING -

DIM	FRAME black	FRAME white	FRAME alu	FRAME bronze	RETAIL PRICE VAT. EXCL.
<b>LC</b>	MIPU 2225 ◆	MIPU 2115 ◆	MIPU 2995 ◆	MIPU 2775 ◆	605€

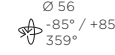

◆ Choose beam:  
 N=narrow 10° or  
 M=medium 25° or  
 W=wide 40°

# Mini-Pi 3 up

230V - driver included in base - **LC** (TRIAC/IGBT) dimmable  
 or  
 \*110V-230V - driver included in base - **1-10** (1-10V) or **PU** (PUSH-DIM) dimmable  
 3 x 4 LED 0.96W (LED incl.) - 350mA - 3 x 456lm - 2700K - CRI >93  
 WALL & CEILING -

DIM	FRAME black	FRAME white	FRAME alu	FRAME bronze	RETAIL PRICE VAT. EXCL.
<b>LC</b>	MIPU 3225 ◆	MIPU 3115 ◆	MIPU 3995 ◆	MIPU 3775 ◆	815€
<b>1-10</b> <b>PU</b> *	MIPU 3325 ◆	MIPU 3315 ◆	MIPU 3395 ◆	MIPU 3375 ◆	845€





# Naga

110V-230V - GU10 LED  
LED bulb excluded - CEILING -

	FRAME black	FRAME white	FRAME bronze	RETAIL PRICE VAT. EXCL.
black RING	NAGA 2112	NAGA 1112		225€
black RING			NAGA 7112	240€
white RING	NAGA 2111	NAGA 1111		225€
white RING			NAGA 7111	240€
bronze RING	NAGA 2117	NAGA 1117		230€
bronze RING			NAGA 7117	250€
gold RING	NAGA 2116	NAGA 1116		230€
gold RING			NAGA 7116	250€



# Pin-Up 1 Round LED

230V - transformer included in base - (IGBT) dimmable  
G53 - 1 x R111 LED max. 60W  
LED bulb excluded - WALL & CEILING -

	FRAME black	FRAME white	FRAME alu	FRAME bronze	FRAME chrome	RETAIL PRICE VAT. EXCL.
DIM						
	PIUP L2050	PIUP L1050	PIUP L3050	PIUP L7050		265€
					PIUP L9050	285€
						325€



# Pin-Up 1 Square LED

230V - transformer included in base - (IGBT) dimmable  
G53 - 1 x R111 LED max. 60W - LED bulb excluded - WALL & CEILING -

	FRAME black	FRAME white	FRAME alu	FRAME bronze	FRAME chrome	RETAIL PRICE VAT. EXCL.
DIM						
	PIUP L2150	PIUP L1150	PIUP L3150	PIUP L7150		270€
					PIUP L9150	290€
						330€

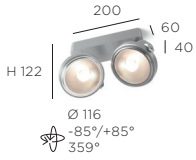

## Pin-Up 2 LED

230V - transformer included in base - **LC** (TRIAC/IGBT) dimmable  
 G53 - 2 x R111 LED max. 45W - LED bulbs excluded - WALL & CEILING -

	FRAME black	FRAME white	FRAME alu	FRAME bronze	FRAME chrome	RETAIL PRICE VAT. EXCL.
DIM	<input type="radio"/>	<input type="radio"/>	<input type="radio"/>	<input type="radio"/>	<input type="radio"/>	
	PIUP L2152	PIUP L1152	PIUP L3152	PIUP L7152	PIUP L9152	455€ 505€ 580€

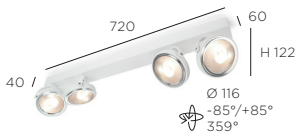

## Pin-Up 4 LED

230V - transformer included in base - **LC** (TRIAC/IGBT) dimmable  
 G53 - 4 x R111 LED max. 45W - LED bulbs excluded - WALL & CEILING -

	FRAME black	FRAME white	FRAME alu	FRAME bronze	RETAIL PRICE VAT. EXCL.
DIM	<input type="radio"/>	<input type="radio"/>	<input type="radio"/>	<input type="radio"/>	
	PIUP L2154	PIUP L1154	PIUP L3154	PIUP L7154	1.050€



## Pin-Up 6 LED

230V - transformer included in base - **LC** (TRIAC/IGBT) dimmable  
 G53 - 6 x R111 LED max. 45W - LED bulbs excluded - WALL & CEILING -

	FRAME black	FRAME white	FRAME alu	FRAME bronze	RETAIL PRICE VAT. EXCL.
DIM	<input type="radio"/>	<input type="radio"/>	<input type="radio"/>	<input type="radio"/>	
	PIUP L2156	PIUP L1156	PIUP L3156	PIUP L7156	1.435€



# R51 up GU10

230V

GU10 - 1 x HALO QPAR16 (alu reflector / no cool beam) max. 50W or 1 x GU10 LED max. 20W

LED bulb excluded - CEILING -

	FRAME black ●	INTERIOR black ●	FRAME black ●	INTERIOR white ○	FRAME white ○	INTERIOR black ●	FRAME white ○	INTERIOR white ○	RETAIL PRICE VAT. EXCL.
black RING ●	MUGU 1222		MUGU 1122		MUGU 1212		MUGU 1112	280€	
chrome RING ●	MUGU 1229		MUGU 1129		MUGU 1219		MUGU 1119	350€	
white RING ○	MUGU 1221		MUGU 1121		MUGU 1211		MUGU 1111	280€	



# R52 up GU10

230V

GU10 - 2 x HALO QPAR16 (alu reflector / no cool beam) max. 50W or 2 x GU10 LED max. 20W

LED bulbs excluded - CEILING -

	FRAME black ●	INTERIOR black ●	FRAME black ●	INTERIOR white ○	FRAME white ○	INTERIOR black ●	FRAME white ○	INTERIOR white ○	RETAIL PRICE VAT. EXCL.
black RING ●	MUGU 2222		MUGU 2122		MUGU 2212		MUGU 2112	350€	
chrome RING ●	MUGU 2229		MUGU 2129		MUGU 2219		MUGU 2119	485€	
white RING ○	MUGU 2221		MUGU 2121		MUGU 2211		MUGU 2111	350€	



# R54 up GU10

230V

GU10 - 4 x HALO QPAR16 (alu reflector / no cool beam) max. 50W or 4 x GU10 LED max. 20W

LED bulbs excluded - CEILING -

	FRAME black ●	INTERIOR black ●	FRAME black ●	INTERIOR white ○	FRAME white ○	INTERIOR black ●	FRAME white ○	INTERIOR white ○	RETAIL PRICE VAT. EXCL.
black RING ●	MUGU 4222		MUGU 4122		MUGU 4212		MUGU 4112	540€	
chrome RING ●	MUGU 4229		MUGU 4129		MUGU 4219		MUGU 4119	810€	
white RING ○	MUGU 4221		MUGU 4121		MUGU 4211		MUGU 4111	540€	



◆ Choose beam:  
 N=narrow 10° or  
 M=medium 25° or  
 W=wide 40°

# R51 up LED

230V - driver included in base - **NO** (non-dimmable) or **C** (IGBT) dimmable  
 1 x 4 LED 0.96W (LED incl.) - 350mA - 456lm - 2700K - CRI >93  
**CEILING** -

DIM		FRAME black	INTERIOR black	FRAME black	INTERIOR white	FRAME white	INTERIOR black	FRAME white	INTERIOR white	RETAIL PRICE VAT. EXCL.
<b>NO</b>	black RING ●	MUWW 1222◆	MUWW 1122◆	MUWW 1212◆	MUWW 1112◆	435€				
	white RING ○	MUWW 1221◆	MUWW 1121◆	MUWW 1211◆	MUWW 1111◆	435€				
<b>C</b>	black RING ●	MUWW 1522◆	MUWW 1622◆	MUWW 1512◆	MUWW 1612◆	445€				
	white RING ○	MUWW 1521◆	MUWW 1621◆	MUWW 1511◆	MUWW 1611◆	445€				

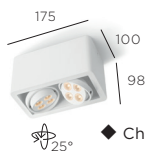

◆ Choose beam:  
 N=narrow 10° or  
 M=medium 25° or  
 W=wide 40°

# R52 up LED

230V - driver included in base - **LC** (TRIAC/IGBT) or **1-10** (1-10V), **PU** (PUSH-DIM) dimmable  
 2 x 4 LED 0.96W (LED incl.) - 350mA - 2 x 456lm - 2700K - CRI >93  
**CEILING** -

DIM		FRAME black	INTERIOR black	FRAME black	INTERIOR white	FRAME white	INTERIOR black	FRAME white	INTERIOR white	RETAIL PRICE VAT. EXCL.
<b>LC</b>	black RING ●	MUWW 2222◆	MUWW 2122◆	MUWW 2212◆	MUWW 2112◆	695€				
	white RING ○	MUWW 2221◆	MUWW 2121◆	MUWW 2211◆	MUWW 2111◆	695€				
<b>1-10</b> <b>PU</b>	black RING ●	MUWW 2222P◆	MUWW 2122P◆	MUWW 2212P◆	MUWW 2112P◆	720€				
	white RING ○	MUWW 2221P◆	MUWW 2121P◆	MUWW 2211P◆	MUWW 2111P◆	720€				



◆ Choose beam:  
 N=narrow 10° or  
 M=medium 25° or  
 W=wide 40°

# R54 up LED

230V - driver included in base - **LC** (TRIAC/IGBT) or **1-10** (1-10V), **PU** (PUSH-DIM) dimmable  
 4 x 4 LED 0.96W (LED incl.) - 350mA - 4 x 456lm - 2700K - CRI >93  
**CEILING** -

DIM		FRAME black	INTERIOR black	FRAME black	INTERIOR white	FRAME white	INTERIOR black	FRAME white	INTERIOR white	RETAIL PRICE VAT. EXCL.
<b>LC</b>	black RING ●	MUWW 4222◆	MUWW 4122◆	MUWW 4212◆	MUWW 4112◆	1.245€				
	white RING ○	MUWW 4221◆	MUWW 4121◆	MUWW 4211◆	MUWW 4111◆	1.245€				
<b>1-10</b> <b>PU</b>	black RING ●	MUWW 4222P◆	MUWW 4122P◆	MUWW 4212P◆	MUWW 4112P◆	1.300€				
	white RING ○	MUWW 4221P◆	MUWW 4121P◆	MUWW 4211P◆	MUWW 4111P◆	1.300€				

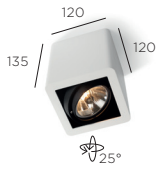

# R07 up

230V - transformer included in base - **NO** (non-dimmable)  
BA15d - 1 x QR70 max. 50W - Bulb excluded - CEILING -

DIM		FRAME black	INTERIOR black	FRAME black	INTERIOR white	FRAME white	INTERIOR black	FRAME white	INTERIOR white	RETAIL PRICE VAT. EXCL.
	black RING									390€
	chrome RING	ARUP 2222	ARUP 2122	ARUP 2129	ARUP 2219	ARUP 2112	ARUP 2119	ARUP 2111		465€
	white RING	ARUP 2221	ARUP 2121	ARUP 2211	ARUP 2111					390€



# R70 up

230V - transformer included in base - **LC** (TRIAC/IGBT) dimmable  
BA15d - 2 x QR70 max. 50W - Bulbs excluded - CEILING -

DIM		FRAME black	INTERIOR black	FRAME black	INTERIOR white	FRAME white	INTERIOR black	FRAME white	INTERIOR white	RETAIL PRICE VAT. EXCL.
	black RING									475€
	chrome RING	ARUP 7222	ARUP 7122	ARUP 7129	ARUP 7219	ARUP 7112	ARUP 7119	ARUP 7111		660€
	white RING	ARUP 7221	ARUP 7121	ARUP 7211	ARUP 7111					475€



# R110 up G53 LED

230V - transformer included in base - **LC** (TRIAC/IGBT) dimmable  
G53 - 1 x R111 LED max. 60W - LED bulb excluded - CEILING -

DIM		FRAME black	INTERIOR black	FRAME black	INTERIOR white	FRAME white	INTERIOR black	FRAME white	INTERIOR white	RETAIL PRICE VAT. EXCL.
	black RING									400€
	chrome RING	ARUP L0222	ARUP L0122	ARUP L0129	ARUP L0219	ARUP L0112	ARUP L0119	ARUP L0111		490€
	white RING	ARUP L0221	ARUP L0121	ARUP L0211	ARUP L0111					400€



# R111 up G53 LED

230V - transformer included in base - **LC** (TRIAC/IGBT) dimmable  
G53 - 2 x R111 LED max. 45W - LED bulbs excluded - CEILING -

DIM		FRAME black	INTERIOR black	FRAME black	INTERIOR white	FRAME white	INTERIOR black	FRAME white	INTERIOR white	RETAIL PRICE VAT. EXCL.
	black RING									510€
	chrome RING	ARUP L1222	ARUP L1122	ARUP L1129	ARUP L1219	ARUP L1112	ARUP L1119	ARUP L1111		700€
	white RING	ARUP L1221	ARUP L1121	ARUP L1211	ARUP L1111					510€

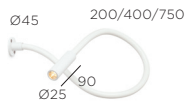

- ◆ Choose beam:  
 N=narrow 10° or  
 M=medium 25° or  
 W=wide 40°

# Scar-Led 1FD built-in 45

110V-230V - remote driver included: **driver does not fit through cutout hole of fixture** - **NO** (non-dimmable)  
 1 x LED 0.96W (LED incl.) - 350mA - 114lm - 2700K - CRI >93

or  
 230V - remote driver included: **driver does not fit through cutout hole of fixture** - **I-10** (1-10V) or **PU** (PUSH-DIM) or **DA** (DALI) dimmable  
 1 x LED 1.38W (LED incl.) - 500mA - 157lm - 2700K - CRI >93  
**WALL** -

	FLEX LENGTH	DIM		FRAME black FLEX black	FRAME white FLEX white	FRAME alu FLEX black	FRAME alu FLEX alu	FRAME bronze FLEX bronze	RETAIL PRICE VAT. EXCL.
no dim	L 200	NO	I	SCAR 4281◆	SCAR 4271◆	SCAR 4201◆	SCAR 4251◆	SCAR 4231◆	280€
no dim	L 400	NO	I	SCAR 4481◆	SCAR 4471◆	SCAR 4401◆	SCAR 4451◆	SCAR 4431◆	285€
no dim	L 750	NO	I	SCAR 4781◆	SCAR 4771◆	SCAR 4701◆	SCAR 6711◆	SCAR 6731◆	295€
dim	L 200	I-10 PU	I	SCAR 4281P◆	SCAR 4271P◆	SCAR 4201P◆	SCAR 4251P◆	SCAR 4231P◆	350€
dim	L 400	I-10 PU	I	SCAR 4481P◆	SCAR 4471P◆	SCAR 4401P◆	SCAR 4451P◆	SCAR 4431P◆	355€
dim	L 750	I-10 PU	I	SCAR 4781P◆	SCAR 4771P◆	SCAR 4701P◆	SCAR 6711P◆	SCAR 6731P◆	365€
dim	L 200	DA	I	SCAR 4281D◆	SCAR 4271D◆	SCAR 4201D◆	SCAR 4251D◆	SCAR 4231D◆	370€
dim	L 400	DA	I	SCAR 4481D◆	SCAR 4471D◆	SCAR 4401D◆	SCAR 4451D◆	SCAR 4431D◆	375€
dim	L 750	DA	I	SCAR 4781D◆	SCAR 4771D◆	SCAR 4701D◆	SCAR 6711D◆	SCAR 6731D◆	385€



- ◆ Choose beam:  
 N=narrow 10° or M=medium 25°  
 or W=wide 40°

# Scar-Led 1FD built-in 60

110V-230V - remote driver included: **driver fits through cutout hole of fixture** - **NO** (non-dimmable)  
 1 x LED 0.96W (LED incl.) - 350mA - 114lm - 2700K - CRI >93  
 aperture : 25 x 45 mm - depth for driver behind fixture : min. 55 mm

or  
 230V - remote driver included: **driver fits through cutout hole of fixture, except DALI does not fit** - **I-10** (1-10V) or **PU** (PUSH-DIM) or **DA** (DALI) dimmable  
 1 x LED 1.38W (LED incl.) - 500mA - 157lm - 2700K - CRI >93  
 aperture : 25 x 55 mm - depth for driver behind fixture : min. 72 mm  
**WALL** -

	FLEX LENGTH	DIM		FRAME black FLEX black	FRAME white FLEX white	FRAME alu FLEX black	FRAME alu FLEX alu	FRAME bronze FLEX bronze	RETAIL PRICE VAT. EXCL.
no dim	L 200	NO	I	SCAR 7281◆	SCAR 7271◆	SCAR 7201◆	SCAR 7251◆	SCAR 7231◆	280€
no dim	L 400	NO	I	SCAR 7481◆	SCAR 7471◆	SCAR 7401◆	SCAR 7451◆	SCAR 7431◆	285€
no dim	L 750	NO	I	SCAR 7781◆	SCAR 7771◆	SCAR 7701◆	SCAR 7751◆	SCAR 7731◆	295€
dim	L 200	I-10 PU	I	SCAR 7281P◆	SCAR 7271P◆	SCAR 7201P◆	SCAR 7251P◆	SCAR 7231P◆	350€
dim	L 400	I-10 PU	I	SCAR 7481P◆	SCAR 7471P◆	SCAR 7401P◆	SCAR 7451P◆	SCAR 7431P◆	355€
dim	L 750	I-10 PU	I	SCAR 7781P◆	SCAR 7771P◆	SCAR 7701P◆	SCAR 7751P◆	SCAR 7731P◆	365€
dim	L 200	DA	I	SCAR 7281D◆	SCAR 7271D◆	SCAR 7201D◆	SCAR 7251D◆	SCAR 7231D◆	370€
dim	L 400	DA	I	SCAR 7481D◆	SCAR 7471D◆	SCAR 7401D◆	SCAR 7451D◆	SCAR 7431D◆	375€
dim	L 750	DA	I	SCAR 7781D◆	SCAR 7771D◆	SCAR 7701D◆	SCAR 7751D◆	SCAR 7731D◆	385€

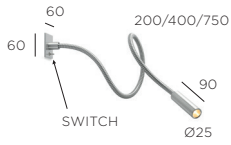

◆ Choose beam:  
 N=narrow 10° or  
 M=medium 25° or  
 W=wide 40°

# Scar-Led 1FDS built-in 60

110V-230V - remote driver included: driver fits through cutout hole of fixture - **NO** ON/OFF on armature

1 x LED 0.96W (LED incl.) - 350mA - 114lm - 2700K - CRI >93  
 aperture : 25 x 45 mm - depth for driver behind fixture : min. 55 mm  
 or

230V - remote driver included: driver fits through cutout hole of fixture - **PU** (PUSH-DIM) on armature

1 x LED 1.38W (LED incl.) - 500mA - 157lm - 2700K - CRI >93  
 aperture : 25 x 55 mm - depth for driver behind fixture : min. 72 mm

WALL -

	FLEX LENGTH	DIM	FRAME black FLEX black	FRAME white FLEX white	FRAME alu FLEX black	FRAME alu FLEX alu	FRAME bronze FLEX bronze	RETAIL PRICE VAT. EXCL.
no dim	L 200	NO	SCAR 7291◆	SCAR 7261◆	SCAR 7211◆	SCAR 7252◆	SCAR 7241◆	290€
no dim	L 400	NO	SCAR 7491◆	SCAR 7461◆	SCAR 7411◆	SCAR 7452◆	SCAR 7441◆	295€
no dim	L 750	NO	SCAR 7791◆	SCAR 7761◆	SCAR 7711◆	SCAR 7752◆	SCAR 7741◆	305€
dim	L 200	PU	SCAR 7291P◆	SCAR 7261P◆	SCAR 7211P◆	SCAR 7252P◆	SCAR 7241P◆	360€
dim	L 400	PU	SCAR 7491P◆	SCAR 7461P◆	SCAR 7411P◆	SCAR 7452P◆	SCAR 7441P◆	365€
dim	L 750	PU	SCAR 7791P◆	SCAR 7761P◆	SCAR 7711P◆	SCAR 7752P◆	SCAR 7741P◆	385€

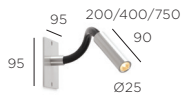

◆ Choose beam:  
 N=narrow 10° or  
 M=medium 25° or  
 W=wide 40°

# Scar-Led 1FD built-in 95

110V-230V - remote driver included: driver fits through cutout hole of fixture - **NO** (non-dimmable)

1 x LED 0.96W (LED incl.) - 350mA - 114lm - 2700K - CRI >93  
 aperture : 25 x 45 mm - depth for driver behind fixture : min. 55 mm  
 or

230V - remote driver included: driver fits through cutout hole of fixture - **1-10** (1-10V) or **PU** (PUSH-DIM) or **DA** (DALI) dimmable

1 x LED 1.38W (LED incl.) - 500mA - 157lm - 2700K - CRI >93  
 aperture : 25 x 55 mm - depth for driver behind fixture : min. 72 mm

WALL -

	FLEX LENGTH	DIM	FRAME black FLEX black	FRAME white FLEX white	FRAME alu FLEX black	FRAME alu FLEX alu	FRAME bronze FLEX bronze	RETAIL PRICE VAT. EXCL.
no dim	L 200	NO	SCAR 8281◆	SCAR 8271◆	SCAR 8211◆	SCAR 8251◆	SCAR 8231◆	285€
no dim	L 400	NO	SCAR 8481◆	SCAR 8471◆	SCAR 8411◆	SCAR 8451◆	SCAR 8431◆	290€
no dim	L 750	NO	SCAR 8781◆	SCAR 8771◆	SCAR 8711◆	SCAR 8751◆	SCAR 8731◆	300€
dim	L 200	1-10 PU	SCAR 8281P◆	SCAR 8271P◆	SCAR 8211P◆	SCAR 8251P◆	SCAR 8231P◆	355€
dim	L 400	1-10 PU	SCAR 8481P◆	SCAR 8471P◆	SCAR 8411P◆	SCAR 8451P◆	SCAR 8431P◆	360€
dim	L 750	1-10 PU	SCAR 8781P◆	SCAR 8771P◆	SCAR 8711P◆	SCAR 8751P◆	SCAR 8731P◆	370€
dim	L 200	DA	SCAR 8281D◆	SCAR 8271D◆	SCAR 8211D◆	SCAR 8251D◆	SCAR 8231D◆	375€
dim	L 400	DA	SCAR 8481D◆	SCAR 8471D◆	SCAR 8411D◆	SCAR 8451D◆	SCAR 8431D◆	380€
dim	L 750	DA	SCAR 8781D◆	SCAR 8771D◆	SCAR 8711D◆	SCAR 8751D◆	SCAR 8731D◆	390€

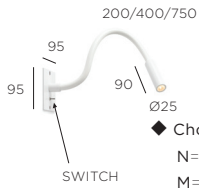

◆ Choose beam:  
 N=narrow 10° or  
 M=medium 25° or  
 W=wide 40°

# Scar-Led 1FDS built-in 95

110V-230V - remote driver included: driver fits through cutout hole of fixture - **NO ON/OFF** on armature  
 1 x LED 0.96W (LED incl.) - 350mA - 114lm - 2700K - CRI >93  
 aperture : 25 x 45 mm - depth for driver behind fixture : min. 55 mm

or  
 230V - remote driver included: driver fits through cutout hole of fixture - **PU (PUSH-DIM)** on armature  
 1 x LED 1.38W (LED incl.) - 500mA - 157lm - 2700K - CRI >93  
 aperture : 25 x 55 mm - depth for driver behind fixture : min. 72 mm

WALL -

	FLEX LENGTH	DIM	FRAME black	FLEX black	FRAME white	FLEX white	FRAME alu	FLEX black	FRAME alu	FLEX alu	FRAME bronze	FLEX bronze	RETAIL PRICE VAT. EXCL.
no dim	L 200	NO	●	●	○	○	●	●	●	○	●	●	295€
no dim	L 400	NO	●	●	○	○	●	●	●	○	●	●	300€
no dim	L 750	NO	●	●	○	○	●	●	●	○	●	●	310€
dim	L 200	PU	●	●	○	○	●	●	●	○	●	●	375€
dim	L 400	PU	●	●	○	○	●	●	●	○	●	●	380€
dim	L 750	PU	●	●	○	○	●	●	●	○	●	●	390€

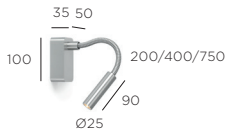

◆ Choose beam:  
 N=narrow 10° or  
 M=medium 25° or  
 W=wide 40°

# Scar-Led 1FD built-up

110V-230V - driver included in base - **NO (non-dimmable)**  
 1 x LED 0.96W (LED incl.) - 350mA - 114lm - 2700K - CRI >93  
 WALL -

	FLEX LENGTH	DIM	FRAME black	FLEX black	FRAME white	FLEX white	FRAME alu	FLEX black	FRAME alu	FLEX alu	FRAME bronze	FLEX bronze	RETAIL PRICE VAT. EXCL.
no dim	L 200	NO	●	●	○	○	●	●	●	○	●	●	300€
no dim	L 400	NO	●	●	○	○	●	●	●	○	●	●	305€
no dim	L 750	NO	●	●	○	○	●	●	●	○	●	●	315€

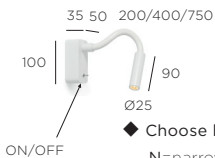

◆ Choose beam:  
 N=narrow 10° or  
 M=medium 25° or  
 W=wide 40°

# Scar-Led 1FDS built-up

110V-230V - driver included in base - **NO ON/OFF** on armature  
 1 x LED 0.96W (LED incl.) - 350mA - 114lm - 2700K - CRI >93  
 WALL -

	FLEX LENGTH	DIM	FRAME black	FLEX black	FRAME white	FLEX white	FRAME alu	FLEX black	FRAME alu	FLEX alu	FRAME bronze	FLEX bronze	RETAIL PRICE VAT. EXCL.
no dim	L 200	NO	●	●	○	○	●	●	●	○	●	●	315€
no dim	L 400	NO	●	●	○	○	●	●	●	○	●	●	320€
no dim	L 750	NO	●	●	○	○	●	●	●	○	●	●	330€



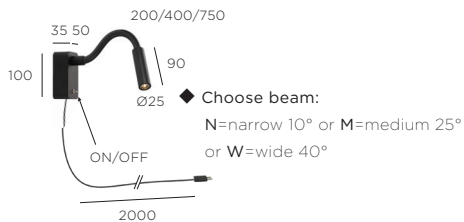

# Scar-Led 1FDS built-up plug

110V-230V - driver included in base - EU-plug - **NO** ON/OFF on armature  
 1 x LED 0.96W (LED incl.) - 350mA - 114lm - 2700K - CRI >93  
 WALL -

	FLEX LENGTH	DIM		FRAME black FLEX black	FRAME white FLEX white	FRAME alu FLEX black	FRAME alu FLEX alu	FRAME bronze FLEX bronze	RETAIL PRICE VAT. EXCL.
no dim	L 200		I	SCAR 4835EU	SCAR 4735EU	SCAR 4335EU	SCAR 4535EU	SCAR 4035EU	360€
no dim	L 400		I	SCAR 4865EU	SCAR 4765EU	SCAR 4365EU	SCAR 4565EU	SCAR 4065EU	365€
no dim	L 750		I	SCAR 4875EU	SCAR 4775EU	SCAR 4375EU	SCAR 4575EU	SCAR 4075EU	380€

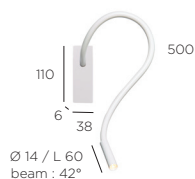

# Scar-Lite 1FD built-in

110V-230V - remote driver included: driver fits through cutout hole of fixture - **NO** (non-dimmable)  
 1 x LED 0.96W (LED incl.) - 350mA - 114lm - 2700K - CRI >93  
 aperture : 25 x 45 mm - depth for driver behind fixture : min. 55 mm  
 or  
 230V - remote driver included: driver fits through cutout hole of fixture - **1-10** (1-10V) or **PU** (PUSH-DIM) or **DA** (DALI) dimmable  
 1 x LED 1.38W (LED incl.) - 500mA - 157lm - 2700K - CRI >93  
 aperture : 25 x 55 mm - depth for driver behind fixture : min. 72 mm  
 WALL -

	FLEX LENGTH	DIM		FRAME black FLEX black	FRAME white FLEX white	FRAME bronze FLEX bronze	RETAIL PRICE VAT. EXCL.
no dim	L 500		I	SCLI 7581	SCLI 7571	SCLI 7531	285€
dim	L 500		I	SCLI 7581P	SCLI 7571P	SCLI 7531P	355€
dim	L 500		I	SCLI 7581D	SCLI 7571D	SCLI 7531D	375€



# Scar-Lite 1FDS built-in

110V-230V - **remote driver included: driver fits through cutout hole of fixture** - **NO ON/OFF on armature**  
 1 x LED 0.96W (**LED incl.**) - 350mA - 114lm - 2700K - CRI >93  
 aperture : 25 x 45 mm - depth for driver behind fixture : min. 55 mm  
**or**

230V - **remote driver included: driver fits through cutout hole of fixture** - **PU (PUSH-DIM) on armature**  
 1 x LED 1.38W (**LED incl.**) - 500mA - 157lm - 2700K - CRI >93  
 aperture : 25 x 55 mm - depth for driver behind fixture : min. 72 mm  
**WALL** -

	FLEX LENGTH	DIM		FRAME black FLEX black	FRAME white FLEX white	FRAME bronze FLEX bronze	RETAIL PRICE VAT. EXCL.
no dim	L 500	NO	I				300€
dim	L 500	PU	I				370€

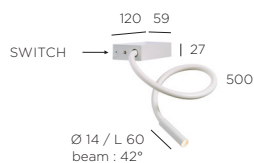

# Scar-Lite 1FDS built-up

110V-230V - **driver in base** - **NO ON/OFF on armature**  
 1 x LED 0.96W (**LED incl.**) - 350mA - 114lm - 2700K - CRI >93  
**or**

230V - **driver in base** - **PU (PUSH-DIM) on armature**  
 1 x LED 1.38W (**LED incl.**) - 500mA - 157lm - 2700K - CRI >93  
**WALL** -

	FLEX LENGTH	DIM		FRAME black FLEX black	FRAME white FLEX white	FRAME bronze FLEX bronze	RETAIL PRICE VAT. EXCL.
no dim	L 500	NO	I				385€
dim	L 500	PU	I				455€

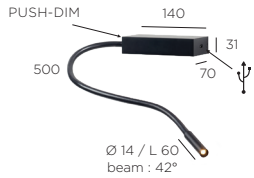

# Scar-Lite 1FDS USB built-up

110V-230V - driver in base - **PU (PUSH-DIM)** on armature

USB charger 5V incl. - compatible with tablets/smartphones and other USB chargeable devices

1 x LED 1.38W (LED incl.) - 500mA - 157lm - 2700K - CRI >93

WALL -

	FLEX LENGTH	DIM	FRAME black FLEX black	FRAME white FLEX white	FRAME bronze FLEX bronze	RETAIL PRICE VAT. EXCL.
dim	L 500	<b>PU</b>	<input checked="" type="radio"/> <input checked="" type="radio"/>	<input type="radio"/> <input type="radio"/>	<input checked="" type="radio"/> <input checked="" type="radio"/>	540€
			SCLIU 5002	SCLIU 5001	SCLIU 5007	

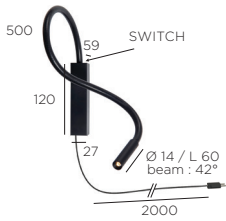

# Scar-Lite 1FDS built-up plug

110V-230V - driver in base - **EU-plug - NO ON/OFF** on armature

1 x LED 0.96W (LED incl.) - 350mA - 114lm - 2700K - CRI >93

or

230V - driver in base - **EU-plug - PU (PUSH-DIM)** on armature

1 x LED 1.38W (LED incl.) - 500mA - 157lm - 2700K - CRI >93

WALL -

	FLEX LENGTH	DIM	FRAME black FLEX black	FRAME white FLEX white	FRAME bronze FLEX bronze	RETAIL PRICE VAT. EXCL.
no dim	L 500	<b>NO</b>	<input checked="" type="radio"/> <input checked="" type="radio"/>	<input type="radio"/> <input type="radio"/>	<input checked="" type="radio"/> <input checked="" type="radio"/>	430€
			SCLI 3502EU	SCLI 3501EU	SCLI 3507EU	
dim	L 500	<b>PU</b>	<input checked="" type="radio"/> <input checked="" type="radio"/>	<input type="radio"/> <input type="radio"/>	<input checked="" type="radio"/> <input checked="" type="radio"/>	505€
			SCLI 5002EU	SCLI 5001EU	SCLI 5007EU	

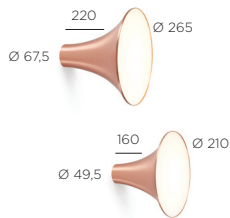

# Sirens W/C diffuser glass

110V-230V

E27 - only energy saving bulbs (LED or FLUO)

bulb size for Ø 210: max. Ø 45 mm L: 115mm, for Ø 265: max. Ø 60mm L: 175mm

LED or FLUO bulb excluded - WALL & CEILING -

	FRAME black	FRAME white	FRAME copper	RETAIL PRICE VAT. EXCL.
Ø 210	SIPR 2112	SIPR 2111		385€
Ø 265	SIPR 2612	SIPR 2611		465€
Ø 210			SIPR 2117	410€
Ø 265			SIPR 2617	490€

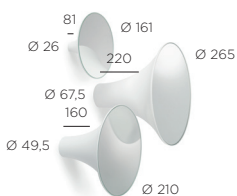

# Sirens W/C mirror

WALL & CEILING

	FRAME black	FRAME white	FRAME copper	RETAIL PRICE VAT. EXCL.
Ø 161	SIPR 1602	SIPR 1601		185€
Ø 210	SIPR 2102	SIPR 2101		290€
Ø 265	SIPR 2602	SIPR 2601		345€
Ø 161			SIPR 1607	205€
Ø 210			SIPR 2107	310€
Ø 265			SIPR 2607	370€



# Sirens W/C frosted glass big mirror + edge mirror

110V-230V

E27 - only energy saving bulbs (LED or FLUO)

bulb size for Ø 210: max. Ø 45 mm L: 115mm, for Ø 265: max. Ø 60mm L: 175mm

LED or FLUO bulb excluded - WALL & CEILING -

	FRAME black	FRAME white	FRAME copper	RETAIL PRICE VAT. EXCL.
Ø 210	SIPR 2122	SIPR 2121		360€
Ø 265	SIPR 2622	SIPR 2621		€420
Ø 210			SIPR 2127	380€
Ø 265			SIPR 2627	435€

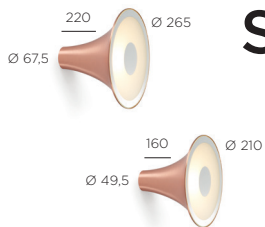

# Sirens W/C frosted glass small mirror + edge mirror

110V-230V

E27 - only energy saving bulbs (LED or FLUO)

bulb size for Ø 210: max. Ø 45 mm L: 115mm, for Ø 265: max. Ø 60mm L: 175mm

LED or FLUO bulb excluded - WALL & CEILING -

	FRAME black	FRAME white	FRAME copper	RETAIL PRICE VAT. EXCL.
Ø 210	SIPR 2132	SIPR 2131		360€
Ø 265	SIPR 2632	SIPR 2631		420€
Ø 210			SIPR 2137	380€
Ø 265			SIPR 2637	435€

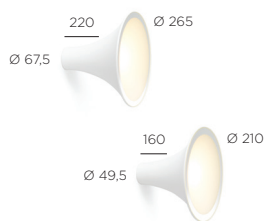

# Sirens W/C frosted glass edge mirror

110V-230V

E27 - only energy saving bulbs (LED or FLUO)

bulb size for Ø 210: max. Ø 45 mm L: 115mm, for Ø 265: max. Ø 60mm L: 175mm

LED or FLUO bulb excluded - WALL & CEILING -

	FRAME black	FRAME white	FRAME copper	RETAIL PRICE VAT. EXCL.
Ø 210	SIPR 2142	SIPR 2141		360€
Ø 265	SIPR 2642	SIPR 2641		420€
Ø 210			SIPR 2147	380€
Ø 265			SIPR 2647	435€

# Suspension



## AUDY-SOLITAIRE

Audy-Solitaire RF	72
Audy-Solitaire RF D+B	73
Audy-Solitaire RL	74
Audy-Solitaire RL D+B	75



## AUSTERE-CHANDELIER 2Y

DESIGN YOUR OWN CHANDELIER	76
Austere-Chandelier 2Y RF 75 remote	81
Austere-Chandelier 2Y RF 100 remote	81
Austere-Chandelier 2Y RS 16 remote	82
Austere-Chandelier 2Y RL 79 remote	82
Austere-Chandelier 2Y RS 16 surface	83
Austere-Chandelier 2Y RL 79 surface	83

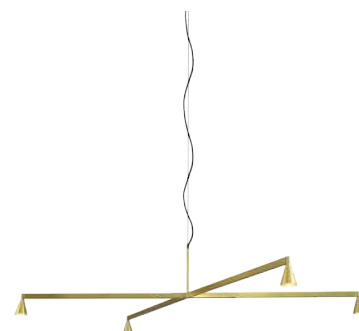

## AUSTERE-CHANDELIER 1X

DESIGN YOUR OWN CHANDELIER	76
Austere-Chandelier 1X RF 75 remote	87
Austere-Chandelier 1X RF 100 remote	87
Austere-Chandelier 1X RS 16 remote	88
Austere-Chandelier 1X RL 79 remote	88
Austere-Chandelier 1X RS 16 surface	89
Austere-Chandelier 1X RL 79 surface	89

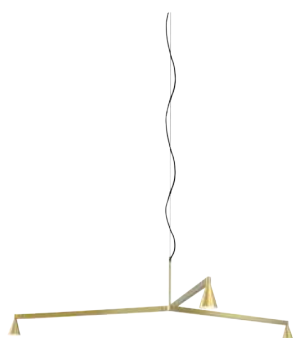

## AUSTERE-CHANDELIER 1Y

DESIGN YOUR OWN CHANDELIER	76
Austere-Chandelier 1Y RF 75 remote	78
Austere-Chandelier 1Y RF 100 remote	78
Austere-Chandelier 1Y RS 16 remote	79
Austere-Chandelier 1Y RL 79 remote	79
Austere-Chandelier 1Y RS 16 surface	80
Austere-Chandelier 1Y RL 79 surface	80



## AUSTERE-CHANDELIER 3Y

DESIGN YOUR OWN CHANDELIER	76
Austere-Chandelier 3Y RF 75 remote	84
Austere-Chandelier 3Y RF 100 remote	84
Austere-Chandelier 3Y RS 16 remote	85
Austere-Chandelier 3Y RL 79 remote	85
Austere-Chandelier 3Y RS 16 surface	86
Austere-Chandelier 3Y RL 79 surface	86



## AUSTERE-CHANDELIER 2X

DESIGN YOUR OWN CHANDELIER	76
Austere-Chandelier 2X RF 75 remote	90
Austere-Chandelier 2X RF 100 remote	90
Austere-Chandelier 2X RS 16 remote	91
Austere-Chandelier 2X RL 79 remote	91
Austere-Chandelier 2X RS 16 surface	92
Austere-Chandelier 2X RL 79 surface	92

# Suspension

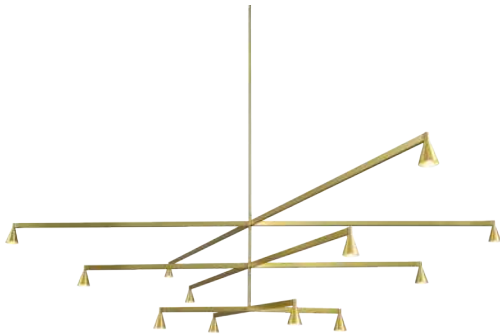

## AUSTERE-CHANDELIER 3X

### DESIGN YOUR OWN CHANDELIER 76

Austere-Chandelier 3X RF 75 remote	93
Austere-Chandelier 3X RF 100 remote	93
Austere-Chandelier 3X RS 16 remote	94
Austere-Chandelier 3X RL 79 remote	94
Austere-Chandelier 3X RS 16 surface	95
Austere-Chandelier 3X RL 79 surface	95



## AUSTERE-SOLITAIRE

Austere-Solitaire RF	99
Austere-Solitaire RF D+B	99
Austere-Solitaire RL	100
Austere-Solitaire RL D+B	100



## I-TRO

I-Tro	106
I-Tro D+B	106



## N-TRO

N-Tro	107
N-Tro D+B	107



## AUSTERE -D

Austere-D1 3 RF 75	96
Austere-D1 3 RF 100	96
Austere-D2 5 RF 75	97
Austere-D2 5 RF 100	97
Austere-D1 3 RL 79	98
Austere-D2 5 RL 79	98



## AUSTERE-SUSPENSION 1+

### DESIGN YOUR OWN SUSPENSION 101

Austere-Suspension 1+ RF 75 remote	103
Austere-Suspension 1+ RF 100 remote	103
Austere-Suspension 1+ RS 16 remote	104
Austere-Suspension 1+ RL 79 remote	104
Austere-Suspension 1+ RS 16 surface	105
Austere-Suspension 1+ RL 79 surface	105



## SIRENS SU

Sirens SU diffuser glass	108
Sirens SU mirror	108
Sirens SU frosted glass	
big mirror + edge mirror	108
Sirens SU frosted glass	
small mirror + edge mirror	109
Sirens SU frosted glass edge mirror	109

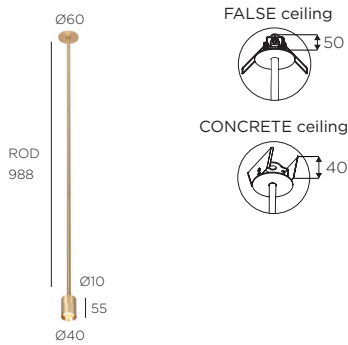

◆ Choose beam:  
M=medium 23°  
or W=wide 40°

# Audy-Solitaire RF

RF = fixed vertical rod of max. 988mm (possibility to shorten with tube cutter)

350mA - **required remote mounted driver see below**

1 x LED array 6.25W (LED incl.) - 350mA - 2700K (633lm) or 3000K (673lm) - CRI >95

FALSE ceiling = aperture : Ø 45 - depth : min. 50 mm - depth for driver in ceiling : min. 70 mm

CONCRETE ceiling = aperture : Ø 45 - depth : min. 40 mm - depth for driver in ceiling : min. 110 mm

SUSPENSION -

		COLOR LED	COVER brass FRAME brass	COVER black FRAME black	COVER white FRAME white	COVER gunmetal FRAME gunmetal	COVER bronze FRAME bronze	COVER nickel FRAME nickel	RETAIL PRICE VAT. EXCL.
FALSE ceiling		2700K	AUSF 1203◆						520€
FALSE ceiling		2700K		AUSF 1202◆	AUSF 1201◆				500€
FALSE ceiling		2700K				AUSF 1204◆	AUSF 1207◆	AUSF 1209◆	585€
FALSE ceiling		3000K	AUSF 1303◆						520€
FALSE ceiling		3000K		AUSF 1302◆	AUSF 1301◆				500€
FALSE ceiling		3000K				AUSF 1304◆	AUSF 1307◆	AUSF 1309◆	585€
FALSE ceiling	+ honeycomb	2700K	AUSF 1203H◆						530€
FALSE ceiling	+ honeycomb	2700K		AUSF 1202H◆	AUSF 1201H◆				510€
FALSE ceiling	+ honeycomb	2700K				AUSF 1204H◆	AUSF 1207H◆	AUSF 1209H◆	595€
FALSE ceiling	+ honeycomb	3000K	AUSF 1303H◆						530€
FALSE ceiling	+ honeycomb	3000K		AUSF 1302H◆	AUSF 1301H◆				510€
FALSE ceiling	+ honeycomb	3000K				AUSF 1304H◆	AUSF 1307H◆	AUSF 1309H◆	595€
CONCRETE ceiling		2700K	AUSC 1203◆						530€
CONCRETE ceiling		2700K		AUSC 1202◆	AUSC 1201◆				510€
CONCRETE ceiling		2700K				AUSC 1204◆	AUSC 1207◆	AUSC 1209◆	595€
CONCRETE ceiling		3000K	AUSC 1303◆						530€
CONCRETE ceiling		3000K		AUSC 1302◆	AUSC 1301◆				510€
CONCRETE ceiling		3000K				AUSC 1304◆	AUSC 1307◆	AUSC 1309◆	595€
CONCRETE ceiling	+ honeycomb	2700K	AUSC 1203H◆						540€
CONCRETE ceiling	+ honeycomb	2700K		AUSC 1202H◆	AUSC 1201H◆				520€
CONCRETE ceiling	+ honeycomb	2700K				AUSC 1204H◆	AUSC 1207H◆	AUSC 1209H◆	605€
CONCRETE ceiling	+ honeycomb	3000K	AUSC 1303H◆						540€
CONCRETE ceiling	+ honeycomb	3000K		AUSC 1302H◆	AUSC 1301H◆				520€
CONCRETE ceiling	+ honeycomb	3000K				AUSC 1304H◆	AUSC 1307H◆	AUSC 1309H◆	605€

## REQUIRED REMOTE MOUNTED DRIVER

DEVICE	DIM.
1 x	LC (TRIAC/IGBT)
2 x	LC (TRIAC/IGBT)
1-2 x	PU (PUSH-DIM) + 1-10 (1-10V)
1-2 x	DA (DALI)
1-2 x	DA (DALI)
2-6 x	PU (PUSH-DIM) + DA (DALI) + 1-10 (1-10V)

DRIVER	NET PRICE
D 6WT	14€
D 18WT	22€
D 15WP*	25€
D 15WDA EU	28€
D 15WDA US*	28€
D 40WDP*	57€

For warranty use only Trizo21® supplied LED drivers as mentioned.  
For all specs and techs about drivers, see [www.trizo21.com/drivers](http://www.trizo21.com/drivers)

driver remote mounting: driver does not fit through cutout hole of fixture  
\*110V-230V



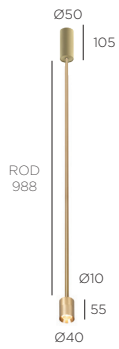

◆ Choose beam:  
M=medium 23°  
or W=wide 40°

# Audy-Solitaire RF D+B

RF = fixed vertical rod of max. 988mm (possibility to shorten with tube cutter)

230V - driver included in base - **LC (TRIAC/IGBT) dimmable**

1 x LED array 6.25W (**LED incl.**) - 350mA - 2700K (633lm) or 3000K (673lm) - CRI >95

**SUSPENSION** -

	DIM	COLOR LED	CANOPY brass FRAME brass	CANOPY black FRAME black	CANOPY white FRAME white	CANOPY gunmetal FRAME gunmetal	CANOPY bronze FRAME bronze	CANOPY nickel FRAME nickel	RETAIL PRICE VAT. EXCL.
		2700K	AUSBD 1213◆						790€
		2700K		AUSBD 1212◆	AUSBD 1211◆				770€
		2700K				AUSBD 1214◆	AUSBD 1217◆	AUSBD 1219◆	930€
		3000K	AUSBD 1313◆						790€
		3000K		AUSBD 1312◆	AUSBD 1311◆				770€
		3000K				AUSBD 1314◆	AUSBD 1317◆	AUSBD 1319◆	930€
+ honeycomb		2700K	AUSBD 1213H◆						800€
+ honeycomb		2700K		AUSBD 1212H◆	AUSBD 1211H◆				780€
+ honeycomb		2700K				AUSBD 1214H◆	AUSBD 1217H◆	AUSBD 1219H◆	940€
+ honeycomb		3000K	AUSBD 1313H◆						800€
+ honeycomb		3000K		AUSBD 1312H◆	AUSBD 1311H◆				780€
+ honeycomb		3000K				AUSBD 1314H◆	AUSBD 1317H◆	AUSBD 1319H◆	940€

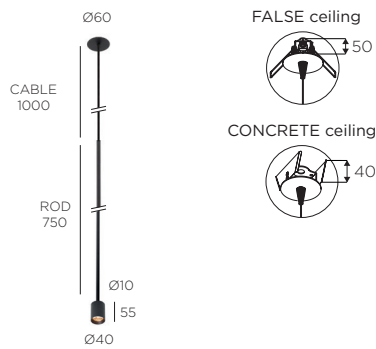

# Audy-Solitaire RL

RL = long vertical rod of 750 mm + powercord - Longer cable lengths available on demand.

350mA - **required remote mounted driver see below**

1 x LED array 6.25W (**LED incl.**) - 350mA - 2700K (633lm) or 3000K (673lm) - CRI >95

**FALSE ceiling** = aperture : Ø 45 - depth : min. 50 mm - depth for driver in ceiling : min. 70 mm

**CONCRETE ceiling** = aperture : Ø 45 - depth : min. 40 mm - depth for driver in ceiling : min. 110 mm

**SUSPENSION** -

CABLE LENGTH	COLOR LED	COVER brass			COVER black			COVER white			COVER gunmetal			COVER bronze			COVER nickel			RETAIL PRICE VAT. EXCL.
		CABLE black	FRAME brass		CABLE black	FRAME black		CABLE white	FRAME white		CABLE black	FRAME gunmetal		CABLE black	FRAME bronze		CABLE black	FRAME nickel		
FALSE ceiling	L1000 2700K	AUCA 1232																	570€	
FALSE ceiling	L1000 2700K				AUCA 1222		AUCA 1211												540€	
FALSE ceiling	L1000 2700K									AUCA 1242		AUCA 1272		AUCA 1292					630€	
FALSE ceiling	L1000 3000K	AUCA 1332																	570€	
FALSE ceiling	L1000 3000K				AUCA 1322		AUCA 1311												540€	
FALSE ceiling	L1000 3000K									AUCA 1342		AUCA 1372		AUCA 1392					630€	
FALSE ceiling + honeycomb	L1000 2700K	AUCA 1232H																	580€	
FALSE ceiling + honeycomb	L1000 2700K				AUCA 1222H		AUCA 1211H												550€	
FALSE ceiling + honeycomb	L1000 2700K									AUCA 1242H		AUCA 1272H		AUCA 1292H					640€	
FALSE ceiling + honeycomb	L1000 3000K	AUCA 1332H																	580€	
FALSE ceiling + honeycomb	L1000 3000K				AUCA 1322H		AUCA 1311H												550€	
FALSE ceiling + honeycomb	L1000 3000K									AUCA 1342H		AUCA 1372H		AUCA 1392H					640€	
CONCRETE ceiling - honeycomb	L1000 2700K	AUCC 1232																	580€	
CONCRETE ceiling - honeycomb	L1000 2700K				AUCC 1222		AUCC 1211												550€	
CONCRETE ceiling - honeycomb	L1000 2700K									AUCC 1242		AUCC 1272		AUCC 1292					640€	
CONCRETE ceiling - honeycomb	L1000 3000K	AUCC 1332																	580€	
CONCRETE ceiling - honeycomb	L1000 3000K				AUCC 1322		AUCC 1311												550€	
CONCRETE ceiling - honeycomb	L1000 3000K									AUCC 1342		AUCC 1372		AUCC 1392					640€	
CONCRETE ceiling + honeycomb	L1000 2700K	AUCC 1232H																	590€	
CONCRETE ceiling + honeycomb	L1000 2700K				AUCC 1222H		AUCC 1211H												560€	
CONCRETE ceiling + honeycomb	L1000 2700K									AUCC 1242H		AUCC 1272H		AUCC 1292H					650€	
CONCRETE ceiling + honeycomb	L1000 3000K	AUCC 1332H																	590€	
CONCRETE ceiling + honeycomb	L1000 3000K				AUCC 1322H		AUCC 1311H												560€	
CONCRETE ceiling + honeycomb	L1000 3000K									AUCC 1342H		AUCC 1372H		AUCC 1392H					650€	

## REQUIRED REMOTE MOUNTED DRIVER

DEVICE	DIM.
1 x	LC (TRIAC/IGBT)
2 x	LC (TRIAC/IGBT)
1-2 x	PU (PUSH-DIM) + 1-10 (1-10V)
1-2 x	DA (DALI)
1-2 x	DA (DALI)
2-6 x	PU (PUSH-DIM) + DA (DALI) + 1-10 (1-10V)

DRIVER	NET PRICE
D 6WT	14€
D 18WT	22€
D 15WP*	25€
D 15WDA EU	28€
D 15WDA US*	28€
D 40WDP*	57€

For warranty use only Trizo21® supplied LED drivers as mentioned.  
For all specs and techs about drivers, see [www.trizo21.com/drivers](http://www.trizo21.com/drivers)

driver remote mounting: driver does not fit through cutout hole of fixture  
\*110V-230V

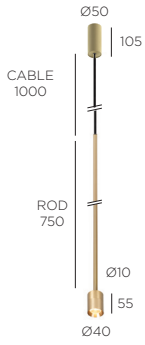

◆ Choose beam:  
M=medium 23°  
or W=wide 40°

# Audy-Solitaire RL D+B

RL = long vertical rod of 750mm + powercord - Longer cable lengths available on demand.

230V - **driver included in base** - **LC (TRIAC/IGBT) dimmable**

1 x LED array 6.25W (**LED incl.**) - 350mA - 2700K (633lm) or 3000K (673lm) - CRI >95

**SUSPENSION** -

	DIM	CABLE LENGTH	COLOR LED	CANOPY brass CABLE black FRAME brass	CANOPY black CABLE black FRAME black	CANOPY white CABLE white FRAME white	CANOPY gunmetal CABLE black FRAME gunmetal	CANOPY bronze CABLE black FRAME bronze	CANOPY nickel CABLE black FRAME nickel	RETAIL PRICE VAT. EXCL.
		L 1000	2700K	AUCBD 1213◆						835€
		L 1000	2700K		AUCBD 1212◆	AUCBD 1211◆				810€
		L 1000	2700K				AUCBD 1214◆	AUCBD 1217◆	AUCBD 1219◆	985€
		L 1000	3000K	AUCBD 1313◆						835€
		L 1000	3000K		AUCBD 1312◆	AUCBD 1311◆				810€
		L 1000	3000K				AUCBD 1314◆	AUCBD 1317◆	AUCBD 1319◆	985€
+ honeycomb		L 1000	2700K	AUCBD 1213H◆						845€
+ honeycomb		L 1000	2700K		AUCBD 1212H◆	AUCBD 1211H◆				820€
+ honeycomb		L 1000	2700K				AUCBD 1214H◆	AUCBD 1217H◆	AUCBD 1219H◆	995€
+ honeycomb		L 1000	3000K	AUCBD 1313H◆						845€
+ honeycomb		L 1000	3000K		AUCBD 1312H◆	AUCBD 1311H◆				820€
+ honeycomb		L 1000	3000K				AUCBD 1314H◆	AUCBD 1317H◆	AUCBD 1319H◆	995€

# DESIGN YOUR OWN AUSTERE-CHANDELIER - REMOTE MOUNTING

## I. Choose the shape of the chandelier: Y or X

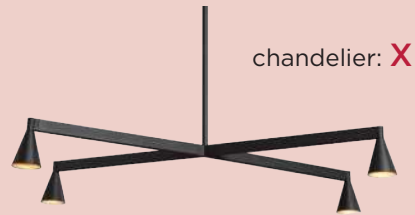
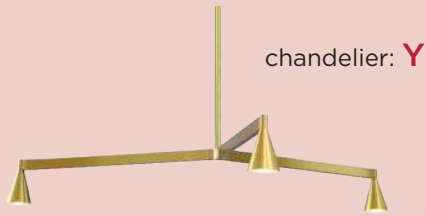

## II. Choose the levels of the chandelier: 1 level, 2 levels or 3 levels

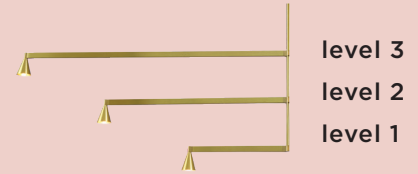

## III. Choose the arm length per level: 250 mm, 500 mm or 750 mm (Each arm on the same level has the same length)

arm 250 MM



arm 500 MM



arm 750 MM



Y chandelier: 3 x 250 mm = Ø 590 mm

Y chandelier: 3 x 500 mm = Ø 1090 mm

Y chandelier: 3 x 750 mm = Ø 1590 mm

X chandelier: 4 x 250 mm = L: 516 mm W: 316 mm

X chandelier: 4 x 500 mm = L: 949 mm W: 565 mm

X chandelier: 4 x 750 mm = L: 1382 mm W: 815 mm

## IV. Choose the colors and the vertical ROD: RS 16, RL 79, RF 75 or RF 100

rod short: **RS 16**

rod long: **RL 79**

rod fixed: **RF 75**

rod fixed: **RF 100**

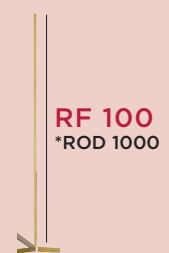
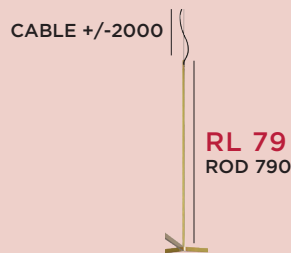
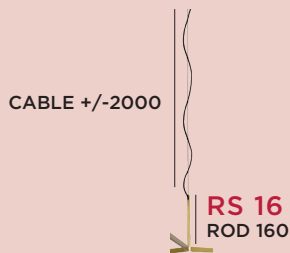

\*Total height depends on the chosen mounting option, see **NOTE** on product page.

Shorter vertical rod available on demand with additional cost.

\*Total height depends on the chosen mounting option, see **NOTE** on product page.

Shorter vertical rod available on demand with additional cost.

## V. Choose your cover or canopy for 'remote mounting' driver:

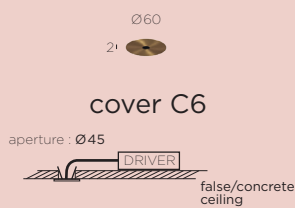

For false ceiling: **RS 16, RL 79, RF 75 & RF 100**  
For concrete ceiling: **RS 16 & RL 79**

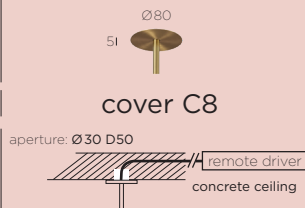

For **RF 75 & RF 100**

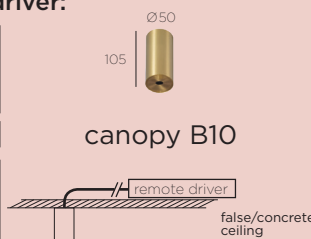

For **RS 16, RL 79, RF 75 & RF 100**

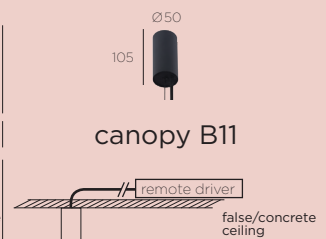

For **RS 16 & RL 79**

## VI. Choose your 'remote mounting' driver:

driver: non-dimmable

driver: 1-10V dimmable  
driver: PUSH-DIM dimmable  
driver: DALI dimmable

# DESIGN YOUR OWN AUSTERE-CHANDELIER - SURFACE MOUNTING

## I. Choose the shape of the chandelier: **Y** or **X**

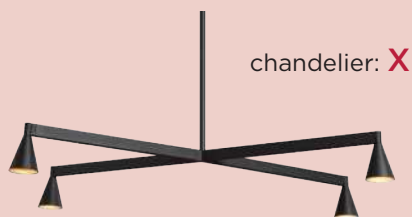
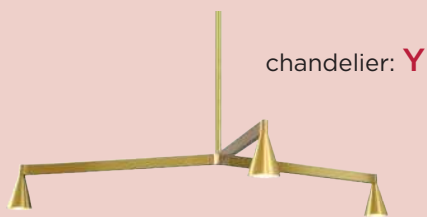

## II. Choose the levels of the chandelier: 1 level, 2 levels or 3 levels

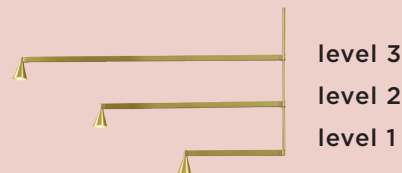

## III. Choose the arm length per level: 250 mm, 500 mm or 750 mm (Each arm on the same level has the same length)

arm 250 MM



arm 500 MM



arm 750 MM



**Y** chandelier: 3 x 250 mm = Ø 590 mm

**Y** chandelier: 3 x 500 mm = Ø 1090 mm

**Y** chandelier: 3 x 750 mm = Ø 1590 mm

**X** chandelier: 4 x 250 mm = L: 516 mm W: 316 mm

**X** chandelier: 4 x 500 mm = L: 949 mm W: 565 mm

**X** chandelier: 4 x 750 mm = L: 1382 mm W: 815 mm

## IV. Choose the colors and the vertical ROD: RS 16 or RL 79

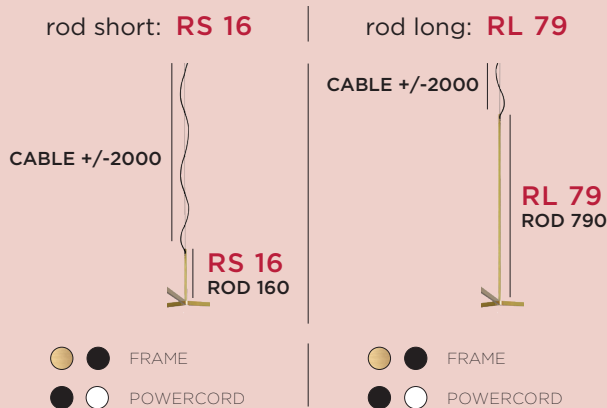

## V. Choose your base (driver incl.) for 'surface mounting':



base B20

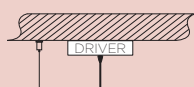

dimnable driver incl. in base  
(1-10V / PUSH-DIM / DALI)  
+ casambi possible  
Only for 1Y, 2Y, 1X  
Max. 6 light-elements



base B21

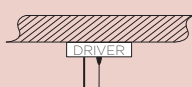

dimnable driver incl. in base  
(1-10V / PUSH-DIM / DALI)  
+ casambi possible  
Only for 1Y, 2Y, 1X  
Max. 6 light-elements

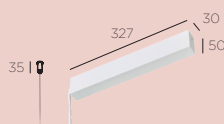

base B32

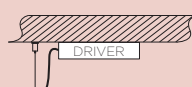

non-dimmable driver incl. in base

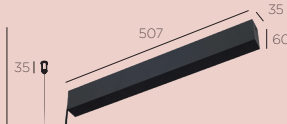

base B50



dimnable driver incl. in base  
(1-10V / PUSH-DIM / DALI)  
+ casambi possible



# Austere-Chandelier 1Y RF 75/ RF 100

Shorter RF ROD available on demand.

350mA - **required remote mounted driver + required cover/canopy see below**

3 x LED array 6W (LED incl.) - 350mA - 3 x 634lm - 2700K - CRI >93

Each arm on the same level has the same length: 3 x 250 mm = Ø 590 mm / 3 x 500 mm = Ø 1090 mm / 3 x 750 mm = Ø 1590 mm.

SUSPENSION -   

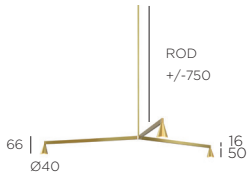

## 1Y RF 75

LENGTH / LEVEL	FRAME brass	FRAME black	RETAIL PRICE VAT. EXCL.
3x 250mm	1Y RF7 2023	1Y RF7 2022	1.465€
3x 500mm	1Y RF7 5023	1Y RF7 5022	1.500€
3x 750mm	1Y RF7 7023	1Y RF7 7022	1.545€

gunmetal, bronze and nickel on demand

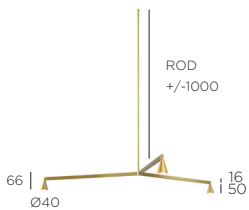

## 1Y RF 100

3x 250mm	1Y RF10 2023	1Y RF10 2022	1.475€
3x 500mm	1Y RF10 5023	1Y RF10 5022	1.510€
3x 750mm	1Y RF10 7023	1Y RF10 7022	1.555€

gunmetal, bronze and nickel on demand

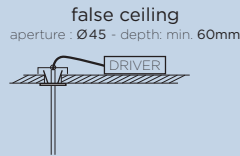

### REQUIRED COVER/CANOPY for Austere-Chandelier 1Y RF 75 / RF 100 with REMOTE MOUNTED DRIVER

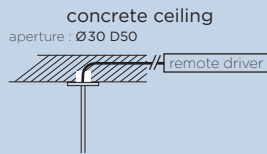

brass		21CO 3300	85€
black		21CO 2200	85€
white		21CO 1100	85€

**NOTE:** If the thickness of the false ceiling is 15mm, the total length of the chandelier:  
**RF 75** with cover C6 will be **778mm**  
**RF 100** with cover C6 will be **1028mm**



brass		21CO 8003	100€
black		21CO 8002	100€
white		21CO 8001	100€

**NOTE:** the total length of the chandelier:  
**RF 75** with cover C8 will be **806mm**  
**RF 100** with cover C8 will be **1056mm**

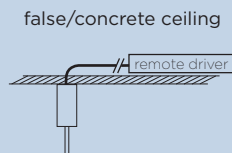
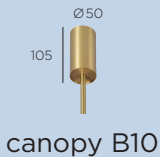

brass		21CP 3333	280€
black		21CP 2222	280€
white		21CP 1111	280€

**NOTE:** the total length of the chandelier:  
**RF 75** with canopy B10 will be **906mm**  
**RF 100** with canopy B10 will be **1156mm**

### REQUIRED REMOTE MOUNTED DRIVER for Austere-Chandelier 1Y RF 75 / RF 100

DEVICE	DIM.	DRIVER	NET PRICE
1 x	NO (non-dimmable)	N 50W*	29€
1 x	PU (PUSH-DIM) + 1-10 (1-10V)	D 80WP*	45€
1 x	PU (PUSH-DIM) + DA (DALI)	D 80WD*	51€

\*driver only fits through cutout hole of fixture with C6, min. depth for driver in false ceiling: 280mm  
 For warranty use only Trizo21® supplied LED drivers as mentioned. For all specs and techs about drivers, see [www.trizo21.com/drivers](http://www.trizo21.com/drivers)

# Austere-Chandelier 1Y RS 16 / RL 79

350mA - **required remote mounted driver + required cover/canopy see below**

3 x LED array 6W (LED incl.) - 350mA - 3 x 634lm - 2700K - CRI >93

Each arm on the same level has the same length: 3 x 250 mm = Ø 590 mm / 3 x 500 mm = Ø 1090 mm / 3 x 750 mm = Ø 1590 mm.

SUSPENSION -

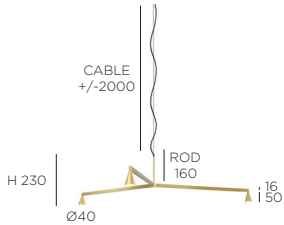

## 1Y RS 16

LENGTH / LEVEL	FRAME brass			FRAME black			FRAME brass			RETAIL PRICE VAT. EXCL.
	POWERCORD black	STEELCABLE black	STEELCABLE black	POWERCORD black	STEELCABLE black	STEELCABLE black	POWERCORD white	STEELCABLE silver		
3x 250mm	1Y RS 2023	1Y RS 2022	1Y RS 2013	1.475€						
3x 500mm	1Y RS 5023	1Y RS 5022	1Y RS 5013	1.510€						
3x 750mm	1Y RS 7023	1Y RS 7022	1Y RS 7013	1.555€						

gunmetal, bronze and nickel on demand

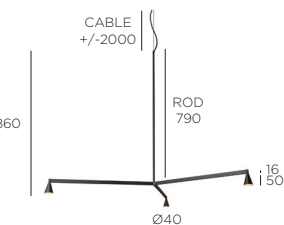

## 1Y RL 79

3x 250mm	1Y RL 2023	1Y RL 2022	1Y RL 2013	1.515€
3x 500mm	1Y RL 5023	1Y RL 5022	1Y RL 5013	1.550€
3x 750mm	1Y RL 7023	1Y RL 7022	1Y RL 7013	1.595€

gunmetal, bronze and nickel on demand

### REQUIRED COVER/CANOPY for Austere-Chandelier 1Y RS 16 / RL 79 with REMOTE MOUNTED DRIVER

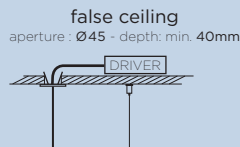

brass		21CO 0003	85€
black		21CO 0002	85€
white		21CO 0001	85€

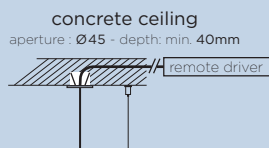

brass		21CO 0013	105€
black		21CO 0012	105€
white		21CO 0011	105€

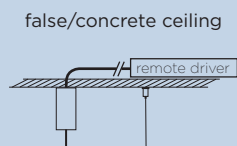
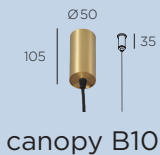

brass		21CP 3003	280€
black		21CP 2002	280€
white		21CP 1001	280€

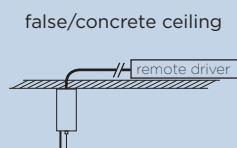

brass		21CP 3033	280€
black		21CP 2022	280€
white		21CP 1011	280€

### REQUIRED REMOTE MOUNTED DRIVER for Austere-Chandelier 1Y RS 16 / RL 79

DEVICE	DIM.	DRIVER	NET PRICE
1 x	NO (non-dimmable)	N 50W*	29€
1 x	PU (PUSH-DIM) + 1-10 (1-10V)	D 80WP*	45€
1 x	PU (PUSH-DIM) + DA (DALI)	D 80WD*	51€

\*driver only fits through cutout hole of fixture with C6, min. depth for driver in false ceiling: 280mm



For warranty use only Trizo21® supplied LED drivers as mentioned. For all specs and techs about drivers, see [www.trizo21.com/drivers](http://www.trizo21.com/drivers)

# Austere-Chandelier 1Y RS 16 / RL 79

350mA - **required base (driver incl.) see below**



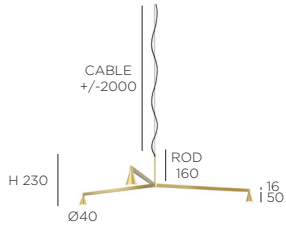

3 x LED array 6W (LED incl.) - 350mA - 3 x 634lm - 2700K - CRI >93

Each arm on the same level has the same length: 3 x 250 mm = Ø 590 mm / 3 x 500 mm = Ø 1090 mm / 3 x 750 mm = Ø 1590 mm.

SUSPENSION -   



## 1Y RS 16

LENGTH / LEVEL	FRAME brass	POWERCORD black	STEELCABLE black	FRAME black	POWERCORD black	STEELCABLE black	FRAME brass	POWERCORD white	STEELCABLE silver	RETAIL PRICE VAT. EXCL.
3x 250mm										1.475€
3x 500mm										1.510€
3x 750mm										1.555€

gunmetal, bronze and nickel on demand

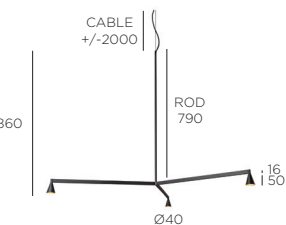



## 1Y RL 79

3x 250mm	1Y RL 2023	1Y RL 2022	1Y RL 2013	1.515€
3x 500mm	1Y RL 5023	1Y RL 5022	1Y RL 5013	1.550€
3x 750mm	1Y RL 7023	1Y RL 7022	1Y RL 7013	1.595€

gunmetal, bronze and nickel on demand

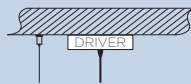

### REQUIRED BASE (DRIVER INCL.) for Austere-Chandelier 1Y RS 16 / RL 79



black  | 1-HO PU DA | BCDP 2402 | 320€ | 110V-230V - **driver included in base**  
 white  | 1-HO PU DA | BCDP 2401 | 320€ | + casambi possible

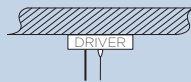
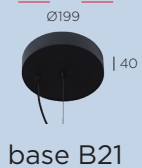

optional: **casambi** | D CAS | 95€ (NET PRICE)



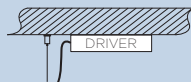
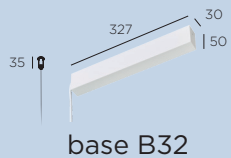

black  | 1-HO PU DA | BCDP 2422 | 320€ | 110V-230V - **driver included in base**  
 white  | 1-HO PU DA | BCDP 2411 | 320€ | + casambi possible

optional: **casambi** | D CAS | 95€ (NET PRICE)

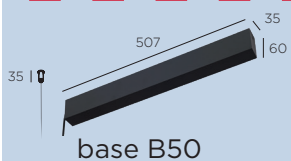

black  | NO | BNDN 0822 | 455€ | 230V - **driver included in base**  
 white  | NO | BNDN 0811 | 455€



black  | 1-HO PU | BDPU 0822 | 555€ | 230V - **driver included in base**  
 white  | 1-HO PU | BDPU 0811 | 555€ | + casambi possible

black  | DA PU | BDDA 0822 | 590€  
 white  | DA PU | BDDA 0811 | 590€

optional: **casambi** | D CAS | 95€ (NET PRICE)



# Austere-Chandelier 2Y RF 75 / RF 100

Shorter RF ROD available on demand.

350mA - **required remote mounted driver + required cover/canopy see below**

6 x LED array 6W (LED incl.) - 350mA - 6 x 634lm - 2700K - CRI >93

Each arm on the same level has the same length: 3 x 250 mm = Ø 590 mm / 3 x 500 mm = Ø 1090 mm / 3 x 750 mm = Ø 1590 mm.

SUSPENSION -

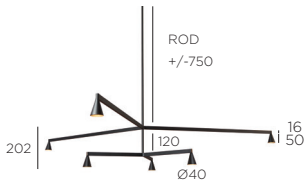

## 2Y RF 75

LENGTH / LEVEL		FRAME brass	FRAME black	RETAIL PRICE VAT. EXCL.
3x 250mm	& 3x 250mm	2Y RF7 2223	2Y RF7 2222	2.800€
3x 250mm	& 3x 500mm	2Y RF7 2523	2Y RF7 2522	2.835€
3x 500mm	& 3x 500mm	2Y RF7 5523	2Y RF7 5522	2.880€
3x 500mm	& 3x 750mm	2Y RF7 5723	2Y RF7 5722	2.915€
3x 750mm	& 3x 750mm	2Y RF7 7723	2Y RF7 7722	2.955€

gunmetal, bronze and nickel on demand

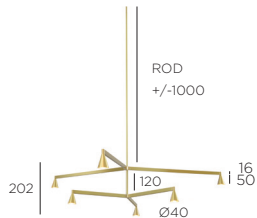

## 2Y RF 100

3x 250mm	& 3x 250mm	2Y RF10 2223	2Y RF10 2222	2.810€
3x 250mm	& 3x 500mm	2Y RF10 2523	2Y RF10 2522	2.845€
3x 500mm	& 3x 500mm	2Y RF10 5523	2Y RF10 5522	2.890€
3x 500mm	& 3x 750mm	2Y RF10 5723	2Y RF10 5722	2.925€
3x 750mm	& 3x 750mm	2Y RF10 7723	2Y RF10 7722	2.965€

gunmetal, bronze and nickel on demand

### REQUIRED COVER/CANOPY for Austere-Chandelier 2Y RF 75 / RF 100 with REMOTE MOUNTED DRIVER

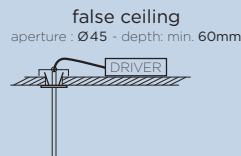

brass		21CO 3300	85€
black		21CO 2200	85€
white		21CO 1100	85€

**NOTE:** If the thickness of the false ceiling is 15mm, the total length of the chandelier:  
**RF 75** with cover C6 will be **914mm**  
**RF 100** with cover C6 will be **1164mm**

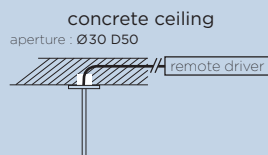

brass		21CO 8003	100€
black		21CO 8002	100€
white		21CO 8001	100€

**NOTE:** the total length of the chandelier:  
**RF 75** with cover C8 will be **942mm**  
**RF 100** with cover C8 will be **1192mm**

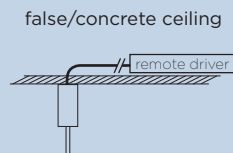
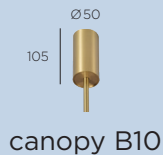

brass		21CP 3333	280€
black		21CP 2222	280€
white		21CP 1111	280€

**NOTE:** the total length of the chandelier:  
**RF 75** with canopy B10 will be **1042mm**  
**RF 100** with canopy B10 will be **1292mm**

### REQUIRED REMOTE MOUNTED DRIVER for Austere-Chandelier 2Y RF 75 / RF 100

DEVICE	DIM.	DRIVER	NET PRICE
1 x	NO (non-dimmable)	N 80W*	33€
1 x	PU (PUSH-DIM) + 1-10 (1-10V)	D 80WP*	45€
1 x	PU (PUSH-DIM) + DA (DALI)	D 80WD*	51€

\*driver only fits through cutout hole of fixture with C6, min. depth for driver in false ceiling: 280mm  
 For warranty use only Trizo21® supplied LED drivers as mentioned. For all specs and techs about drivers, see [www.trizo21.com/drivers](http://www.trizo21.com/drivers)

# Austere-Chandelier 2Y RS 16 / RL 79

350mA - **required remote mounted driver + required cover/canopy see below**

6 x LED array 6W (LED incl.) - 350mA - 6 x 634lm - 2700K - CRI >93

Each arm on the same level has the same length: 3 x 250 mm = Ø 590 mm / 3 x 500 mm = Ø 1090 mm / 3 x 750 mm = Ø 1590 mm.

SUSPENSION -

		LENGTH / LEVEL		LENGTH / LEVEL	FRAME brass	POWERCORD black	STEELCABLE black	FRAME black	POWERCORD black	STEELCABLE black	FRAME brass	POWERCORD white	STEELCABLE silver	RETAIL PRICE VAT. EXCL.
	<b>2Y RS 16</b>	3x 250mm	&	3x 250mm	2Y RS 2223			2Y RS 2222			2Y RS 2213			2.810€
		3x 250mm	&	3x 500mm	2Y RS 2523			2Y RS 2522			2Y RS 2513			2.845€
		3x 500mm	&	3x 500mm	2Y RS 5523			2Y RS 5522			2Y RS 5513			2.890€
		3x 500mm	&	3x 750mm	2Y RS 5723			2Y RS 5722			2Y RS 5713			2.925€
		3x 750mm	&	3x 750mm	2Y RS 7723			2Y RS 7722			2Y RS 7713			2.965€
gunmetal, bronze and nickel on demand														

	<b>2Y RL 79</b>	3x 250mm	&	3x 250mm	2Y RL 2223			2Y RL 2222			2Y RL 2213			2.850€
		3x 250mm	&	3x 500mm	2Y RL 2523			2Y RL 2522			2Y RL 2513			2.885€
		3x 500mm	&	3x 500mm	2Y RL 5523			2Y RL 5522			2Y RL 5513			2.930€
		3x 500mm	&	3x 750mm	2Y RL 5723			2Y RL 5722			2Y RL 5713			2.965€
		3x 750mm	&	3x 750mm	2Y RL 7723			2Y RL 7722			2Y RL 7713			3.005€
gunmetal, bronze and nickel on demand														

## REQUIRED COVER/CANOPY for Austere-Chandelier 2Y RS 16 / RL 79 with REMOTE MOUNTED DRIVER

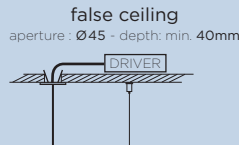

brass		21CO 0003	85€
black		21CO 0002	85€
white		21CO 0001	85€

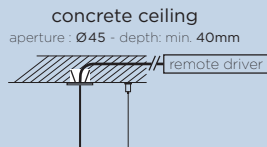

brass		21CO 0013	105€
black		21CO 0012	105€
white		21CO 0011	105€

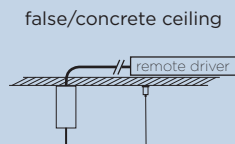
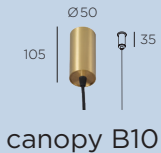

brass		21CP 3003	280€
black		21CP 2002	280€
white		21CP 1001	280€

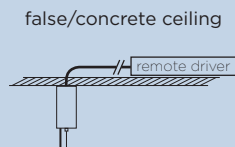

brass		21CP 3033	280€
black		21CP 2022	280€
white		21CP 1011	280€

## REQUIRED REMOTE MOUNTED DRIVER for Austere-Chandelier 2Y RS 16 / RL 79

DEVICE	DIM.	DRIVER	NET PRICE
1 x	NO (non-dimmable)	N 80W*	33€
1 x	PU (PUSH-DIM) + I-10 (1-10V)	D 80WP*	45€
1 x	PU (PUSH-DIM) + DA (DALI)	D 80WD*	51€

\*driver only fits through cutout hole of fixture with C6, min. depth for driver in false ceiling: 280mm

For warranty use only Trizo21® supplied LED drivers as mentioned. For all specs and techs about drivers, see [www.trizo21.com/drivers](http://www.trizo21.com/drivers)

# Austere-Chandelier 2Y RS 16 / RL 79

350mA - **required base (driver incl.) see below**

6 x LED array 6W (LED incl.) - 350mA - 6 x 634lm - 2700K - CRI >93

Each arm on the same level has the same length: 3 x 250 mm = Ø 590 mm / 3 x 500 mm = Ø 1090 mm / 3 x 750 mm = Ø 1590 mm.

SUSPENSION -

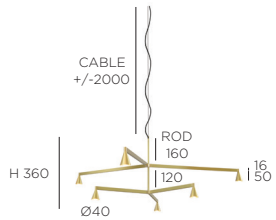

## 2Y RS 16

LENGTH / LEVEL		LENGTH / LEVEL		FRAME brass	POWERCORD black	STEELCABLE black	FRAME black	POWERCORD black	STEELCABLE black	FRAME brass	POWERCORD white	STEELCABLE silver	RETAIL PRICE VAT. EXCL.
3x 250mm	&	3x 250mm											2.810€
3x 250mm	&	3x 500mm											2.845€
3x 500mm	&	3x 500mm											2.890€
3x 500mm	&	3x 750mm											2.925€
3x 750mm	&	3x 750mm											2.965€

gunmetal, bronze and nickel on demand

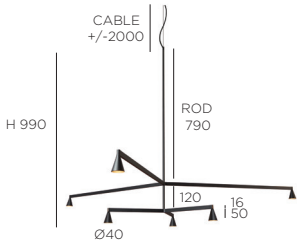

## 2Y RL 79

3x 250mm	&	3x 250mm											2.850€
3x 250mm	&	3x 500mm											2.885€
3x 500mm	&	3x 500mm											2.930€
3x 500mm	&	3x 750mm											2.965€
3x 750mm	&	3x 750mm											3.005€

gunmetal, bronze and nickel on demand

### REQUIRED BASE (DRIVER INCL.) for Austere-Chandelier 2Y RS 16 / RL 79

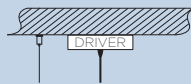

black		BCDP 2402	320€	110V-230V - <b>driver included in base</b>
white		BCDP 2401	320€	+ casambi possible
optional: <b>casambi</b>	D CAS		95€ (NET PRICE)	

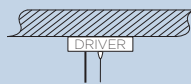

black		BCDP 2422	320€	110V-230V - <b>driver included in base</b>
white		BCDP 2411	320€	+ casambi possible
optional: <b>casambi</b>	D CAS		95€ (NET PRICE)	

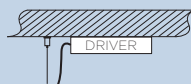
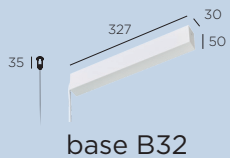

black		BNDN 0822	455€	230V - <b>driver included in base</b>
white		BNDN 0811	455€	

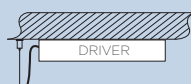
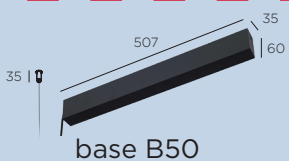

black		BDPU 0822	555€	230V - <b>driver included in base</b>
white		BDPU 0811	555€	+ casambi possible
black		BDDA 0822	590€	
white		BDDA 0811	590€	
optional: <b>casambi</b>	D CAS		95€ (NET PRICE)	

# Austere-Chandelier 3Y RF 75 / RF 100

Shorter RF ROD available on demand.

350mA - **required remote mounted driver + required cover/canopy see below**

9 x LED array 6W (LED incl.) - 350mA - 9 x 634lm - 2700K - CRI >93

Each arm on the same level has the same length: 3 x 250 mm = Ø 590 mm / 3 x 500 mm = Ø 1090 mm / 3 x 750 mm = Ø 1590 mm.

SUSPENSION -

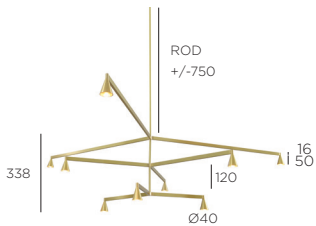

## 3Y RF 75

LENGTH / LEVEL			FRAME brass	FRAME black	RETAIL PRICE VAT. EXCL.
3x 250mm	&	3x 250mm	3Y RF7 22523	3Y RF7 22522	
3x 250mm	&	3x 500mm	3Y RF7 25523	3Y RF7 25522	4.205€
3x 250mm	&	3x 500mm	3Y RF7 25723	3Y RF7 25722	4.245€
3x 500mm	&	3x 500mm	3Y RF7 55723	3Y RF7 55722	4.280€
3x 500mm	&	3x 750mm	3Y RF7 57723	3Y RF7 57722	4.325€

gunmetal, bronze and nickel on demand

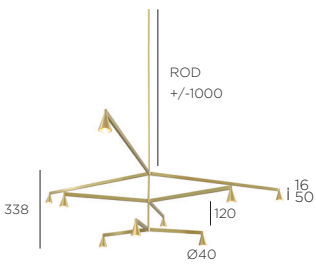

## 3Y RF 100

3x 250mm	&	3x 250mm	3Y RF10 22523	3Y RF10 22522	4.180€
3x 250mm	&	3x 500mm	3Y RF10 25523	3Y RF10 25522	4.215€
3x 250mm	&	3x 500mm	3Y RF10 25723	3Y RF10 25722	4.255€
3x 500mm	&	3x 500mm	3Y RF10 55723	3Y RF10 55722	4.290€
3x 500mm	&	3x 750mm	3Y RF10 57723	3Y RF10 57722	4.335€

gunmetal, bronze and nickel on demand

### REQUIRED COVER/CANOPY for Austere-Chandelier 3Y RF 75 / RF 100 with REMOTE MOUNTED DRIVER

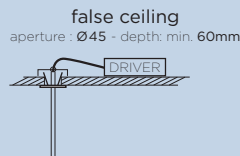

brass	21CO 3300	85€
black	21CO 2200	85€
white	21CO 1100	85€

**NOTE:** If the thickness of the false ceiling is 15mm, the total length of the chandelier:  
**RF 75** with cover C6 will be **1050mm**  
**RF 100** with cover C6 will be **1300mm**

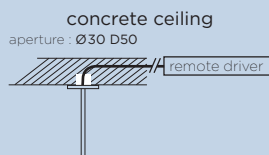

brass	21CO 8003	100€
black	21CO 8002	100€
white	21CO 8001	100€

**NOTE:** the total length of the chandelier:  
**RF 75** with cover C8 will be **1078mm**  
**RF 100** with cover C8 will be **1328mm**

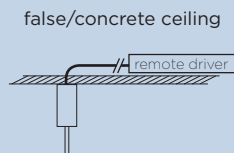
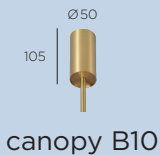

brass	21CP 3333	280€
black	21CP 2222	280€
white	21CP 1111	280€

**NOTE:** the total length of the chandelier:  
**RF 75** with canopy B10 will be **1178mm**  
**RF 100** with canopy B10 will be **1428mm**

### REQUIRED REMOTE MOUNTED DRIVER for Austere-Chandelier 3Y RF 75 / RF 100

DEVICE	DIM.	DRIVER	NET PRICE
1 x	NO (non-dimmable)	N 80W*	33€
1 x	PU (PUSH-DIM) + 1-10 (1-10V)	D 80WP*	45€
1 x	PU (PUSH-DIM) + DA (DALI)	D 80WD*	51€

\*driver only fits through cutout hole of fixture with C6, min. depth for driver in false ceiling: 280mm  
 For warranty use only Trizo21® supplied LED drivers as mentioned. For all specs and techs about drivers, see [www.trizo21.com/drivers](http://www.trizo21.com/drivers)

# Austere-Chandelier 3Y RS 16 / RL 79

350mA - **required remote mounted driver + required cover/canopy see below**

9 x LED array 6W (LED incl.) - 350mA - 9 x 634lm - 2700K - CRI >93

Each arm on the same level has the same length: 3 x 250 mm = Ø 590 mm / 3 x 500 mm = Ø 1090 mm / 3 x 750 mm = Ø 1590 mm.

SUSPENSION -

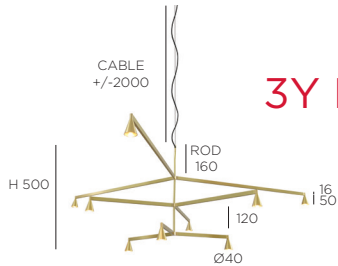

## 3Y RS 16

LENGTH / LEVEL		LENGTH / LEVEL		LENGTH / LEVEL	FRAME brass	POWERCORD black	STEELCABLE black	FRAME black	POWERCORD black	STEELCABLE black	FRAME brass	POWERCORD white	STEELCABLE silver	RETAIL PRICE VAT. EXCL.
3x 250mm	&	3x 250mm	&	3x 500mm	3Y RS 22523									4.180€
3x 250mm	&	3x 500mm	&	3x 500mm	3Y RS 25523									4.215€
3x 250mm	&	3x 500mm	&	3x 750mm	3Y RS 25723									4.255€
3x 500mm	&	3x 500mm	&	3x 750mm	3Y RS 55723									4.290€
3x 500mm	&	3x 750mm	&	3x 750mm	3Y RS 57723									4.335€

bronze and nickel on demand

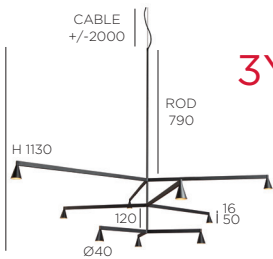

## 3Y RL 79

3x 250mm	&	3x 250mm	&	3x 500mm	3Y RL 22523									4.220€
3x 250mm	&	3x 500mm	&	3x 500mm	3Y RL 25523									4.255€
3x 250mm	&	3x 500mm	&	3x 750mm	3Y RL 25723									4.295€
3x 500mm	&	3x 500mm	&	3x 750mm	3Y RL 55723									4.330€
3x 500mm	&	3x 750mm	&	3x 750mm	3Y RL 57723									4.375€

bronze and nickel on demand

### REQUIRED COVER/CANOPY for Austere-Chandelier 3Y RS 16 / RL 79 with REMOTE MOUNTED DRIVER

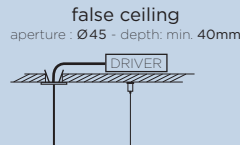

brass		21CO 0003	85€
black		21CO 0002	85€
white		21CO 0001	85€

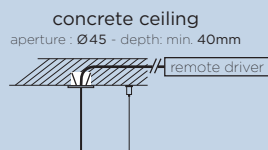

brass		21CO 0013	105€
black		21CO 0012	105€
white		21CO 0011	105€

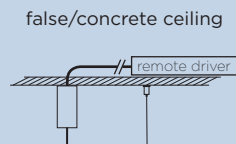
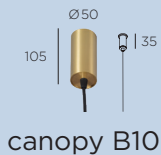

brass		21CP 3003	280€
black		21CP 2002	280€
white		21CP 1001	280€

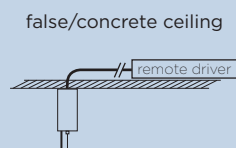

brass		21CP 3033	280€
black		21CP 2022	280€
white		21CP 1011	280€

### REQUIRED REMOTE MOUNTED DRIVER for Austere-Chandelier 3Y RS 16 / RL 79

DEVICE	DIM.	DRIVER	NET PRICE
1 x	NO (non-dimmable)	N 80W*	33€
1 x	PU (PUSH-DIM) + I-10 (1-10V)	D 80WP*	45€
1 x	PU (PUSH-DIM) + DA (DALI)	D 80WD*	51€

\*driver only fits through cutout hole of fixture with C6, min. depth for driver in false ceiling: 280mm  
For warranty use only Trizo21® supplied LED drivers as mentioned. For all specs and techs about drivers, see [www.trizo21.com/drivers](http://www.trizo21.com/drivers)

# Austere-Chandelier 3Y RS 16 / RL 79

350mA - **required base (driver incl.) see below**

9 x LED array 6W (LED incl.) - 350mA - 9 x 634lm - 2700K - CRI >93

Each arm on the same level has the same length: 3 x 250 mm = Ø 590 mm / 3 x 500 mm = Ø 1090 mm / 3 x 750 mm = Ø 1590 mm.

SUSPENSION -

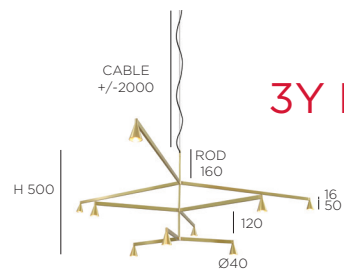

## 3Y RS 16

LENGTH / LEVEL		LENGTH / LEVEL		LENGTH / LEVEL	FRAME brass	POWERCORD black	STEELCABLE black	FRAME black	POWERCORD black	STEELCABLE black	FRAME brass	POWERCORD white	STEELCABLE silver	RETAIL PRICE VAT. EXCL.
3x 250mm	&	3x 250mm	&	3x 500mm	●	●	●	●	●	●	●	●	●	4.180€
3x 250mm	&	3x 500mm	&	3x 500mm	●	●	●	●	●	●	●	●	●	4.215€
3x 250mm	&	3x 500mm	&	3x 750mm	●	●	●	●	●	●	●	●	●	4.255€
3x 500mm	&	3x 500mm	&	3x 750mm	●	●	●	●	●	●	●	●	●	4.290€
3x 500mm	&	3x 750mm	&	3x 750mm	●	●	●	●	●	●	●	●	●	4.335€

gunmetal, bronze and nickel on demand

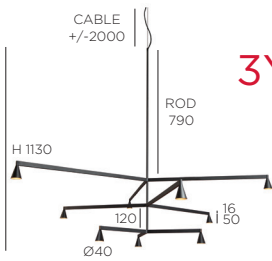

## 3Y RL 79

3x 250mm	&	3x 250mm	&	3x 500mm	●	●	●	●	●	●	●	●	●	4.220€
3x 250mm	&	3x 500mm	&	3x 500mm	●	●	●	●	●	●	●	●	●	4.255€
3x 250mm	&	3x 500mm	&	3x 750mm	●	●	●	●	●	●	●	●	●	4.295€
3x 500mm	&	3x 500mm	&	3x 750mm	●	●	●	●	●	●	●	●	●	4.330€
3x 500mm	&	3x 750mm	&	3x 750mm	●	●	●	●	●	●	●	●	●	4.375€

gunmetal, bronze and nickel on demand

### REQUIRED BASE (DRIVER INCL.) for Austere-Chandelier 3Y RS 16 / RL 79

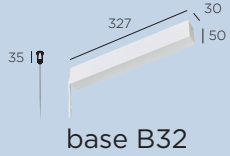

base B32

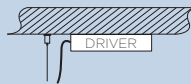

black ● | NO  
white ○ | NO

BNDN 0822 | 455€  
BNDN 0811 | 455€

230V - driver included in base

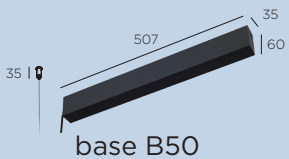

base B50

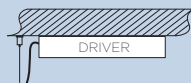

black ● | 140 PU  
white ○ | 140 PU

BDPU 0822 | 555€  
BDPU 0811 | 555€

230V - driver included in base  
+ casambi possible

black ● | DA PU  
white ○ | DA PU

BDDA 0822 | 590€  
BDDA 0811 | 590€

optional: casambi | D CAS | 95€ (NET PRICE)



# Austere-Chandelier 1X RF 75 / RF 100

Shorter RF ROD available on demand.

350mA - **required remote mounted driver + required cover/canopy see below**

4 x LED array 6W (LED incl.) - 350mA - 4 x 634lm - 2700K - CRI >93

Each arm on the same level has the same length: 4 x 250 mm = L 516 mm W 316 mm / 4 x 500 mm = L 949 mm W 565 mm / 4 x 750 mm = L 1382 mm W 815 mm

SUSPENSION -  

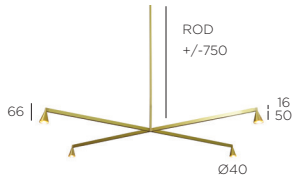

## 1X RF 75

LENGTH / LEVEL	FRAME brass	FRAME black	RETAIL PRICE VAT. EXCL.
4x 250mm	1X RF7 2023	1X RF7 2022	1.850€
4x 500mm	1X RF7 5023	1X RF7 5022	1.900€
4x 750mm	1X RF7 7023	1X RF7 7022	1.955€

gunmetal, bronze and nickel on demand

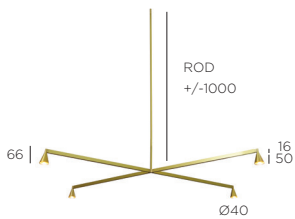

## 1X RF 100

4x 250mm	1X RF10 2023	1X RF10 2022	1.860€
4x 500mm	1X RF10 5023	1X RF10 5022	1.910€
4x 750mm	1X RF10 7023	1X RF10 7022	1.965€

gunmetal, bronze and nickel on demand

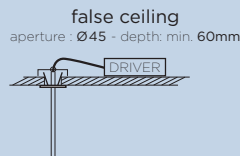

### REQUIRED COVER/CANOPY for Austere-Chandelier 1X RF 75 / RF 100 with REMOTE MOUNTED DRIVER



brass		21CO 3300	85€
black		21CO 2200	85€
white		21CO 1100	85€

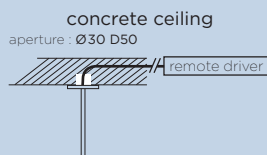

**NOTE:** If the thickness of the false ceiling is 15mm, the total length of the chandelier:  
**RF 75** with cover C6 will be **778mm**  
**RF 100** with cover C6 will be **1028mm**

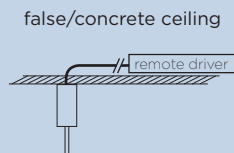
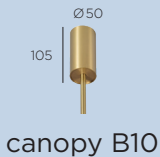

brass		21CO 8003	100€
black		21CO 8002	100€
white		21CO 8001	100€

**NOTE:** the total length of the chandelier:  
**RF 75** with cover C8 will be **806mm**  
**RF 100** with cover C8 will be **1056mm**



brass		21CP 3333	280€
black		21CP 2222	280€
white		21CP 1111	280€

**NOTE:** the total length of the chandelier:  
**RF 75** with canopy B10 will be **906mm**  
**RF 100** with canopy B10 will be **1156mm**

### REQUIRED REMOTE MOUNTED DRIVER for Austere-Chandelier 1X RF 75 / RF 100

DEVICE	DIM.	DRIVER	NET PRICE
1 x	NO (non-dimmable)	N 50W*	29€
1 x	PU (PUSH-DIM) + 1-10 (1-10V)	D 80WP*	45€
1 x	PU (PUSH-DIM) + DA (DALI)	D 80WD*	51€

\*driver only fits through cutout hole of fixture with C6, min. depth for driver in false ceiling: 280mm  
 For warranty use only Trizo21® supplied LED drivers as mentioned. For all specs and techs about drivers, see [www.trizo21.com/drivers](http://www.trizo21.com/drivers)

# Austere-Chandelier 1X RS 16 / RL 79

350mA - **required remote mounted driver + required cover/canopy see below**

4 x LED array 6W (LED incl.) - 350mA - 4 x 634lm - 2700K - CRI >93

Each arm on the same level has the same length: 4 x 250 mm = L 516 mm W 316 mm / 4 x 500 mm = L 949 mm W 565 mm / 4 x 750 mm = L 1382 mm W 815 mm.

SUSPENSION -

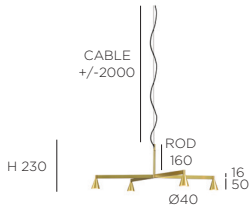

## 1X RS 16

LENGTH / LEVEL	FRAME brass			FRAME black			FRAME brass			RETAIL PRICE VAT. EXCL.
	POWERCORD black	STEELCABLE black	STEELCABLE black	POWERCORD black	STEELCABLE black	STEELCABLE black	POWERCORD white	STEELCABLE silver		
4x 250mm	1X RS 2023	1X RS 2022	1X RS 2013	1.860€						
4x 500mm	1X RS 5023	1X RS 5022	1X RS 5013	1.910€						
4x 750mm	1X RS 7023	1X RS 7022	1X RS 7013	1.965€						

gunmetal, bronze and nickel on demand

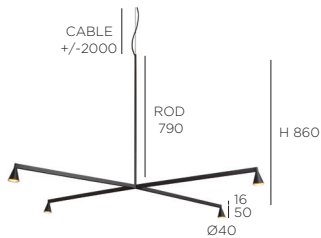

## 1X RL 79

4x 250mm	1X RL 2023	1X RL 2022	1X RL 2013	1.900€
4x 500mm	1X RL 5023	1X RL 5022	1X RL 5013	1.950€
4x 750mm	1X RL 7023	1X RL 7022	1X RL 7013	2.005€

gunmetal, bronze and nickel on demand

### REQUIRED COVER/CANOPY for Austere-Chandelier 1X RS 16 / RL 79 with REMOTE MOUNTED DRIVER

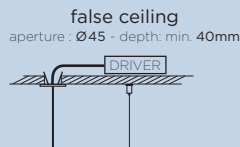

brass		21CO 0003	85€
black		21CO 0002	85€
white		21CO 0001	85€

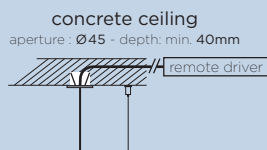

brass		21CO 0013	105€
black		21CO 0012	105€
white		21CO 0011	105€

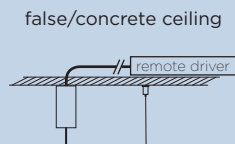
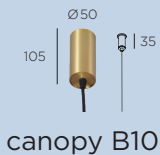

brass		21CP 3003	280€
black		21CP 2002	280€
white		21CP 1001	280€

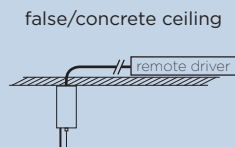

brass		21CP 3033	280€
black		21CP 2022	280€
white		21CP 1011	280€

### REQUIRED REMOTE MOUNTED DRIVER for Austere-Chandelier 1X RS 16 / RL 79

DEVICE	DIM.	DRIVER	NET PRICE
1 x	NO (non-dimmable)	N 50W*	29€
1 x	PU (PUSH-DIM) + 1-10 (1-10V)	D 80WP*	45€
1 x	PU (PUSH-DIM) + DA (DALI)	D 80WD*	51€

\*driver only fits through cutout hole of fixture with C6, min. depth for driver in false ceiling: 280mm

For warranty use only Trizo21® supplied LED drivers as mentioned. For all specs and techs about drivers, see [www.trizo21.com/drivers](http://www.trizo21.com/drivers)



# Austere-Chandelier 1X RS 16 / RL 79

350mA - **required base (driver incl.) see below**

4 x LED array 6W (LED incl.) - 350mA - 4 x 634lm - 2700K - CRI >93

Each arm on the same level has the same length: 4 x 250 mm = L 516 mm W 316 mm / 4 x 500 mm = L 949 mm W 565 mm / 4 x 750 mm = L 1382 mm W 815 mm.

SUSPENSION -

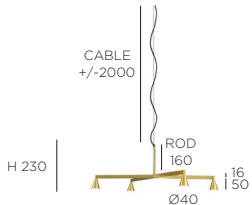

## 1X RS 16

LENGTH / LEVEL	FRAME brass	POWERCORD black	STEELCABLE black	FRAME black	POWERCORD black	STEELCABLE black	FRAME brass	POWERCORD white	STEELCABLE silver	RETAIL PRICE VAT. EXCL.
4x 250mm	●	●	●	●	●	●	●	●	●	1.860€
4x 500mm				●	●	●				1.910€
4x 750mm										1.965€

gunmetal, bronze and nickel on demand

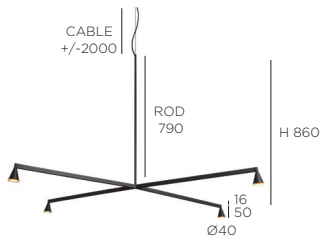

## 1X RL 79

4x 250mm				●	●	●				1.900€
4x 500mm				●	●	●				1.950€
4x 750mm										2.005€

gunmetal, bronze and nickel on demand

### REQUIRED BASE (DRIVER INCL.) for Austere-Chandelier 1X RS 16 / RL 79

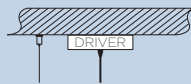

black ●	1-10 PU DA	BCDP 2402	320€	110V-230V - <b>driver included in base</b>
white ○	1-10 PU DA	BCDP 2401	320€	+ casambi possible
optional: <b>casambi</b>		D CAS	95€ (NET PRICE)	

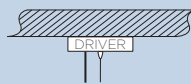

black ●	1-10 PU DA	BCDP 2422	320€	110V-230V - <b>driver included in base</b>
white ○	1-10 PU DA	BCDP 2411	320€	+ casambi possible
optional: <b>casambi</b>		D CAS	95€ (NET PRICE)	

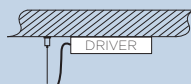
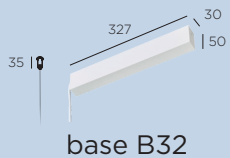

black ●	NO	BNDN 0822	455€	230V - <b>driver included in base</b>
white ○	NO	BNDN 0811	455€	

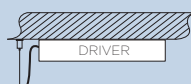
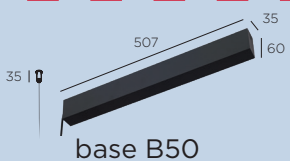

black ●	1-10 PU	BDPU 0822	555€	230V - <b>driver included in base</b>
white ○	1-10 PU	BDPU 0811	555€	+ casambi possible
black ●	DA PU	BDDA 0822	590€	
white ○	DA PU	BDDA 0811	590€	
optional: <b>casambi</b>		D CAS	95€ (NET PRICE)	



# Austere-Chandelier 2X RF 75 / RF 100

Shorter RF ROD available on demand.

350mA - **required remote mounted driver + required cover/canopy see below**

8 x LED array 6W (LED incl.) - 350mA - 8 x 634lm - 2700K - CRI >93

Each arm on the same level has the same length: 4 x 250 mm = L 516 mm W 316 mm / 4 x 500 mm = L 949 mm W 565 mm / 4 x 750 mm = L 1382 mm W 815 mm.

SUSPENSION -   

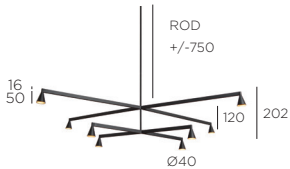

## 2X RF 75

LENGTH / LEVEL		LENGTH / LEVEL	FRAME		RETAIL PRICE VAT. EXCL.
			brass	black	
4x 250mm	&	4x 500mm	2X RF7 2523	2X RF7 2522	3.620€
4x 500mm	&	4x 750mm	2X RF7 5723	2X RF7 5722	3.720€

gunmetal, bronze and nickel on demand

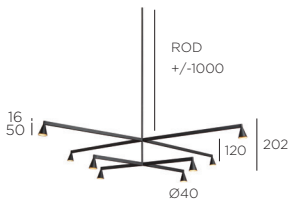

## 2X RF 100

4x 250mm	&	4x 500mm	2X RF10 2523	2X RF10 2522	3.630€
4x 500mm	&	4x 750mm	2X RF10 5723	2X RF10 5722	3.730€

gunmetal, bronze and nickel on demand

### REQUIRED COVER/CANOPY for Austere-Chandelier 2X RF 75 / RF 100 with REMOTE MOUNTED DRIVER

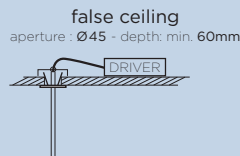

brass	21CO 3300	85€
black	21CO 2200	85€
white	21CO 1100	85€

**NOTE:** If the thickness of the false ceiling is 15mm, the total length of the chandelier:  
**RF 75** with cover C6 will be **914mm**  
**RF 100** with cover C6 will be **1164mm**

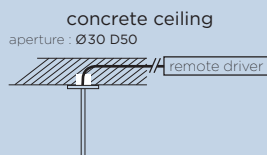

brass	21CO 8003	100€
black	21CO 8002	100€
white	21CO 8001	100€

**NOTE:** the total length of the chandelier:  
**RF 75** with cover C8 will be **942mm**  
**RF 100** with cover C8 will be **1192mm**

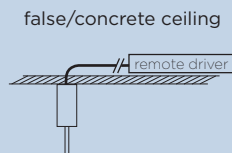
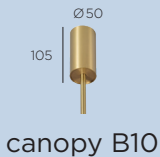

brass	21CP 3333	280€
black	21CP 2222	280€
white	21CP 1111	280€

**NOTE:** the total length of the chandelier:  
**RF 75** with canopy B10 will be **1042mm**  
**RF 100** with canopy B10 will be **1292mm**

### REQUIRED REMOTE MOUNTED DRIVER for Austere-Chandelier 2X RF 75 / RF 100

DEVICE	DIM.	DRIVER	NET PRICE
1 x	NO (non-dimmable)	N 80W*	33€
1 x	PU (PUSH-DIM) + 1-10 (1-10V)	D 80WP*	45€
1 x	PU (PUSH-DIM) + DA (DALI)	D 80WD*	51€

\*driver only fits through cutout hole of fixture with C6, min. depth for driver in false ceiling: 280mm  
 For warranty use only Trizo21® supplied LED drivers as mentioned. For all specs and techs about drivers, see [www.trizo21.com/drivers](http://www.trizo21.com/drivers)

# Austere-Chandelier 2X RS 16 / RL 79

350mA - **required remote mounted driver + required cover/canopy see below**

8 x LED array 6W (LED incl.) - 350mA - 8 x 634lm - 2700K - CRI >93

Each arm on the same level has the same length: 4 x 250 mm = L 516 mm W 316 mm / 4 x 500 mm = L 949 mm W 565 mm / 4 x 750 mm = L 1382 mm W 815 mm.

SUSPENSION -

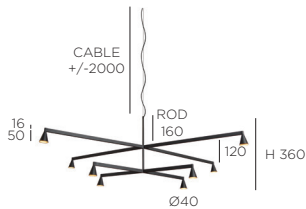

## 2X RS 16

LENGTH / LEVEL		LENGTH / LEVEL		FRAME brass	POWERCORD black	STEELCABLE black	FRAME black	POWERCORD black	STEELCABLE black	FRAME brass	POWERCORD white	STEELCABLE silver	RETAIL PRICE VAT. EXCL.
4x 250mm	&	4x 500mm		●	●	●	●	●	●	●	●	●	2X RS 2523   3.630€
4x 500mm	&	4x 750mm		●	●	●	●	●	●	●	●	●	2X RS 5723   3.730€

gunmetal, bronze and nickel on demand

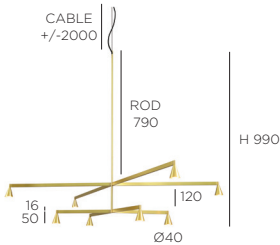

## 2X RL 79

4x 250mm	&	4x 500mm		●	●	●	●	●	●	●	●	●	2X RL 2523   3.670€
4x 500mm	&	4x 750mm		●	●	●	●	●	●	●	●	●	2X RL 5723   3.770€

gunmetal, bronze and nickel on demand

### REQUIRED COVER/CANOPY for Austere-Chandelier 2X RS 16 / RL 79 with REMOTE MOUNTED DRIVER

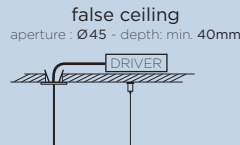

brass	●	21CO 0003	85€
black	●	21CO 0002	85€
white	●	21CO 0001	85€

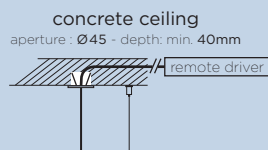

brass	●	21CO 0013	105€
black	●	21CO 0012	105€
white	●	21CO 0011	105€

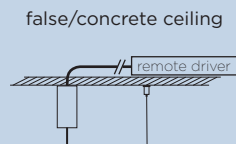
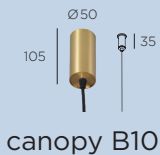

brass	●	21CP 3003	280€
black	●	21CP 2002	280€
white	●	21CP 1001	280€

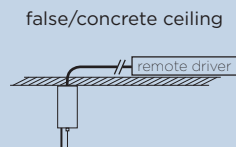

brass	●	21CP 3033	280€
black	●	21CP 2022	280€
white	●	21CP 1011	280€

### REQUIRED REMOTE MOUNTED DRIVER for Austere-Chandelier 2X RS 16 / RL 79

DEVICE	DIM.	DRIVER	NET PRICE
1 x	NO (non-dimmable)	N 80W*	33€
1 x	PU (PUSH-DIM) + I-10 (1-10V)	D 80WP*	45€
1 x	PU (PUSH-DIM) + DA (DALI)	D 80WD*	51€

\*driver only fits through cutout hole of fixture with C6, min. depth for driver in false ceiling: 280mm  
For warranty use only Trizo21® supplied LED drivers as mentioned. For all specs and techs about drivers, see [www.trizo21.com/drivers](http://www.trizo21.com/drivers)

# Austere-Chandelier 2X RS 16 / RL 79

350mA - **required base (driver incl.) see below**

8 x LED array 6W **(LED incl.)** - 350mA - 8 x 634lm - 2700K - CRI >93

Each arm on the same level has the same length: 4 x 250 mm = L 516 mm W 316 mm / 4 x 500 mm = L 949 mm W 565 mm / 4 x 750 mm = L 1382 mm W 815 mm.

**SUSPENSION** -

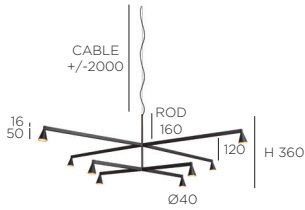

## 2X RS 16

LENGTH / LEVEL		LENGTH / LEVEL		FRAME brass	POWERCORD black	STEELCABLE black	FRAME black	POWERCORD black	STEELCABLE black	FRAME brass	POWERCORD white	STEELCABLE silver	RETAIL PRICE VAT. EXCL.
4x 250mm	&	4x 500mm		●	●	●	●	●	●	●	○	○	2X RS 2523   3.630€
4x 500mm	&	4x 750mm											2X RS 5722   3.730€

gunmetal, bronze and nickel on demand

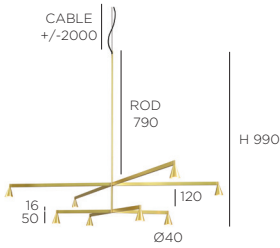

## 2X RL 79

4x 250mm	&	4x 500mm											2X RL 2523   3.670€
4x 500mm	&	4x 750mm											2X RL 5723   3.770€

gunmetal, bronze and nickel on demand

### REQUIRED BASE (DRIVER INCL.) for Austere-Chandelier 2X RS 16 / RL 79

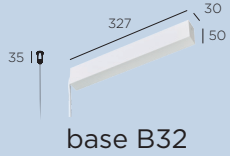

base B32

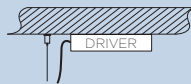

black ●	NO	BNDN 0822	455€	230V - <b>driver included in base</b>
white ○	NO	BNDN 0811	455€	

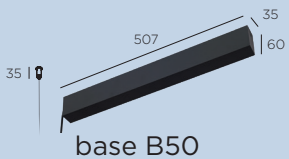

base B50



black ●	HO PU	BDPU 0822	555€	230V - <b>driver included in base</b>
white ○	HO PU	BDPU 0811	555€	+ casambi possible
black ●	DA PU	BDDA 0822	590€	
white ○	DA PU	BDDA 0811	590€	
optional: casambi		D CAS	95€ (NET PRICE)	



# Austere-Chandelier 3X RF 75 / RF 100

Shorter RF ROD available on demand.

350mA - **required remote mounted driver + required cover/canopy see below**

12 x LED array 6W (LED incl.) - 350mA - 12 x 634lm - 2700K - CRI >93

Each arm on the same level has the same length: 4 x 250 mm = L 516 mm W 316 mm / 4 x 500 mm = L 949 mm W 565 mm / 4 x 750 mm = L 1382 mm W 815 mm

SUSPENSION -   

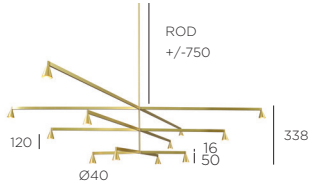

## 3X RF 75

LENGTH / LEVEL		LENGTH / LEVEL		LENGTH / LEVEL	FRAME	FRAME	RETAIL PRICE
4x 250mm	&	4x 500mm	&	4x 750mm			5.440€
						gunmetal, bronze and nickel on demand	
						3X RF7 25723	3X RF7 25722

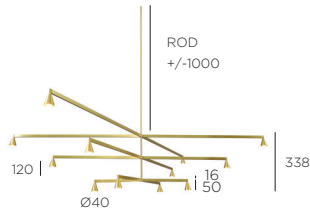

## 3X RF 100

4x 250mm	&	4x 500mm	&	4x 750mm	3X RF10 25723	3X RF10 25722	5.450€
						gunmetal, bronze and nickel on demand	

### REQUIRED COVER/CANOPY for Austere-Chandelier 3X RF 75 / RF 100 with REMOTE MOUNTED DRIVER

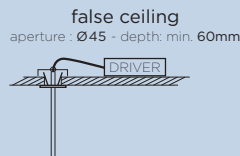

brass 	21CO 3300	85€
black 	21CO 2200	85€
white 	21CO 1100	85€

**NOTE:** If the thickness of the false ceiling is 15mm, the total length of the chandelier:  
**RF 75** with cover C6 will be **1050mm**  
**RF 100** with cover C6 will be **1300mm**

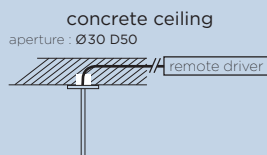

brass 	21CO 8003	100€
black 	21CO 8002	100€
white 	21CO 8001	100€

**NOTE:** the total length of the chandelier:  
**RF 75** with cover C8 will be **1078mm**  
**RF 100** with cover C8 will be **1328mm**

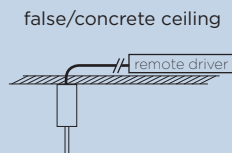
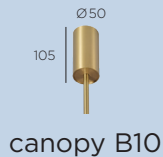

brass 	21CP 3333	280€
black 	21CP 2222	280€
white 	21CP 1111	280€

**NOTE:** the total length of the chandelier:  
**RF 75** with canopy B10 will be **1178mm**  
**RF 100** with canopy B10 will be **1428mm**

### REQUIRED REMOTE MOUNTED DRIVER for Austere-Chandelier 3X RF 75 / RF 100

DEVICE	DIM.	DRIVER	NET PRICE
1 x	NO (non-dimmable)	N 80W*	33€
1 x	PU (PUSH-DIM) + 1-10 (1-10V)	D 80WP*	45€
1 x	PU (PUSH-DIM) + DA (DALI)	D 80WD*	51€

\*driver only fits through cutout hole of fixture with C6, min. depth for driver in false ceiling: 280mm  
 For warranty use only Trizo21® supplied LED drivers as mentioned. For all specs and techs about drivers, see [www.trizo21.com/drivers](http://www.trizo21.com/drivers)

# Austere-Chandelier 3X RS 16 / RL 79

350mA - **required remote mounted driver + required cover/canopy see below**

12 x LED array 6W (LED incl.) - 350mA - 12 x 634lm - 2700K - CRI >93

Each arm on the same level has the same length: 4 x 250 mm = L 516 mm W 316 mm / 4 x 500 mm = L 949 mm W 565 mm / 4 x 750 mm = L 1382 mm W 815 mm.

SUSPENSION -

CABLE +/-2000  
ROD 160  
H 500  
16, 50, 120, Ø40

## 3X RS 16

LENGTH / LEVEL	&	LENGTH / LEVEL	&	LENGTH / LEVEL		FRAME brass	POWERCORD black	STEELCABLE black		FRAME black	POWERCORD black	STEELCABLE black		FRAME brass	POWERCORD white	STEELCABLE silver		RETAIL PRICE VAT. EXCL.
4x 250mm	&	4x 500mm	&	4x 750mm														5.450€

gunmetal, bronze and nickel on demand

CABLE +/-2000  
ROD 790  
H 1130  
120, 16, 50, Ø40

## 3X RL 79

LENGTH / LEVEL	&	LENGTH / LEVEL	&	LENGTH / LEVEL		FRAME brass	POWERCORD black	STEELCABLE black		FRAME black	POWERCORD black	STEELCABLE black		FRAME brass	POWERCORD white	STEELCABLE silver		RETAIL PRICE VAT. EXCL.
4x 250mm	&	4x 500mm	&	4x 750mm														5.4890

gunmetal, bronze and nickel on demand

### REQUIRED COVER/CANOPY for Austere-Chandelier 3X RS 16 / RL 79 with REMOTE MOUNTED DRIVER

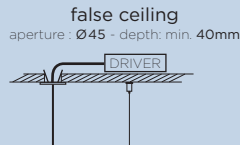

brass		21CO 0003	85€
black		21CO 0002	85€
white		21CO 0001	85€

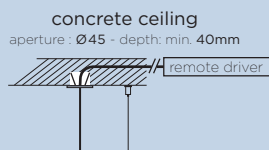

brass		21CO 0013	105€
black		21CO 0012	105€
white		21CO 0011	105€

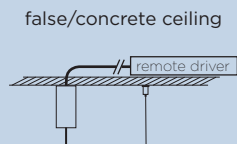
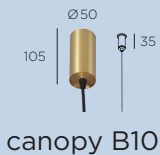

brass		21CP 3003	280€
black		21CP 2002	280€
white		21CP 1001	280€

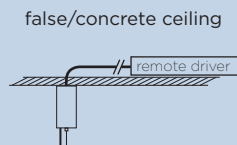

brass		21CP 3033	280€
black		21CP 2022	280€
white		21CP 1011	280€

### REQUIRED REMOTE MOUNTED DRIVER for Austere-Chandelier 3X RS 16 / RL 79

DEVICE	DIM.	DRIVER	NET PRICE
1 x	NO (non-dimmable)	N 80W*	33€
1 x	PU (PUSH-DIM) + 1-10 (1-10V)	D 80WP*	45€
1 x	PU (PUSH-DIM) + DA (DALI)	D 80WD*	51€



\*driver only fits through cutout hole of fixture with C6, min. depth for driver in false ceiling: 280mm  
For warranty use only Trizo21® supplied LED drivers as mentioned. For all specs and techs about drivers, see [www.trizo21.com/drivers](http://www.trizo21.com/drivers)

# Austere-Chandelier 3X RS 16 / RL 79

350mA - **required base (driver incl.) see below**

12 x LED array 6W (**LED incl.**) - 350mA - 12 x 634lm - 2700K - CRI >93

Each arm on the same level has the same length: 4 x 250 mm = L 516 mm W 316 mm / 4 x 500 mm = L 949 mm W 565 mm / 4 x 750 mm = L 1382 mm W 815 mm.

**SUSPENSION** -   

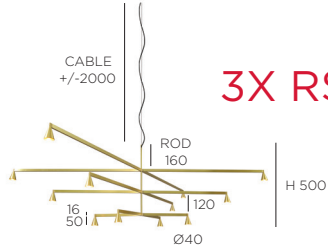

## 3X RS 16

LENGTH / LEVEL		LENGTH / LEVEL		LENGTH / LEVEL		FRAME	POWERCORD	STEELCABLE	RETAIL PRICE
4x 250mm	&	4x 500mm	&	4x 750mm		● FRAME brass	● POWERCORD black	● STEELCABLE black	3X RS 25723
						● FRAME black	● POWERCORD black	● STEELCABLE black	3X RS 25722
						● FRAME brass	○ POWERCORD white	○ STEELCABLE silver	3X RS 25713
									5.450€

gunmetal, bronze and nickel on demand

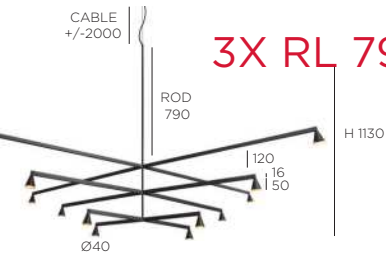

## 3X RL 79

4x 250mm	&	4x 500mm	&	4x 750mm		3X RL 25723	3X RL 25722	3X RL 25713	5.4890
----------	---	----------	---	----------	--	-------------	-------------	-------------	--------

gunmetal, bronze and nickel on demand

### REQUIRED BASE (DRIVER INCL.) for Austere-Chandelier 3X RS 16 / RL 79

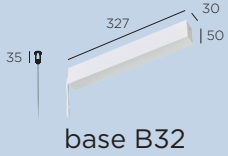

base B32

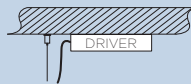

black ●	NO	BNDN 0822	455€	230V - <b>driver included in base</b>
white ○	NO	BNDN 0811	455€	

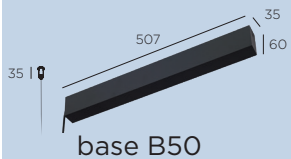

base B50



black ●	HO PU	BDPU 0822	555€	230V - <b>driver included in base</b>
white ○	HO PU	BDPU 0811	555€	+ casambi possible
black ●	DA PU	BDDA 0822	590€	
white ○	DA PU	BDDA 0811	590€	
optional: casambi		D CAS	95€ (NET PRICE)	

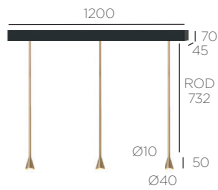

Position of the light fixture in the base can be adjusted

# Austere-D1 3 RF 75

230V - driver included in base - **LC** (TRIAC/IGBT) or **1-10** (1-10V) or **PU** (PUSH-DIM) or **DA** (DALI) dimmable  
 3 x LED array 6W (LED incl.) - 350mA - 3 x 634lm - 2700K - CRI >93  
 Shorter RF ROD available on demand. - **SUSPENSION** -

	DIM	FRAME brass	FRAME black	FRAME white	FRAME gunmetal	FRAME bronze	FRAME nickel	RETAIL PRICE VAT. EXCL.
black BASE		AFLC 31273	AFLC 31272	AFLC 31271				1.695€
white BASE		AFLC 31173	AFLC 31172	AFLC 31171				1.695€
black BASE					AFLC 31274	AFLC 31277	AFLC 31279	1.995€
white BASE					AFLC 31174	AFLC 31177	AFLC 31179	1.995€
black BASE		AFPU 31273	AFPU 31272	AFPU 31271				1.695€
white BASE		AFPU 31173	AFPU 31172	AFPU 31171				1.695€
black BASE					AFPU 31274	AFPU 31277	AFPU 31279	1.995€
white BASE					AFPU 31174	AFPU 31177	AFPU 31179	1.995€
black BASE		AFDA 31273	AFDA 31272	AFDA 31271				1.695€
white BASE		AFDA 31173	AFDA 31172	AFDA 31171				1.695€
black BASE					AFDA 31274	AFDA 31277	AFDA 31279	1.995€
white BASE					AFDA 31174	AFDA 31177	AFDA 31179	1.995€

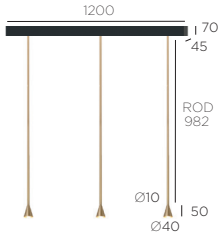

Position of the light fixture in the base can be adjusted

# Austere-D1 3 RF 100

230V - driver included in base - **LC** (TRIAC/IGBT) or **1-10** (1-10V) or **PU** (PUSH-DIM) or **DA** (DALI) dimmable  
 3 x LED array 6W (LED incl.) - 350mA - 3 x 634lm - 2700K - CRI >93  
 Shorter RF ROD available on demand. - **SUSPENSION** -

	DIM	FRAME brass	FRAME black	FRAME white	FRAME gunmetal	FRAME bronze	FRAME nickel	RETAIL PRICE VAT. EXCL.
black BASE		AFLC 31293	AFLC 31292	AFLC 31291				1.725€
white BASE		AFLC 31193	AFLC 31192	AFLC 31191				1.725€
black BASE					AFLC 31294	AFLC 31297	AFLC 31299	2.025€
white BASE					AFLC 31194	AFLC 31197	AFLC 31199	2.025€
black BASE		AFPU 31293	AFPU 31292	AFPU 31291				1.725€
white BASE		AFPU 31193	AFPU 31192	AFPU 31191				1.725€
black BASE					AFPU 31294	AFPU 31297	AFPU 31299	2.025€
white BASE					AFPU 31194	AFPU 31197	AFPU 31199	2.025€
black BASE		AFDA 31293	AFDA 31292	AFDA 31291				1.725€
white BASE		AFDA 31193	AFDA 31192	AFDA 31191				1.725€
black BASE					AFDA 31294	AFDA 31297	AFDA 31299	2.025€
white BASE					AFDA 31194	AFDA 31197	AFDA 31199	2.025€



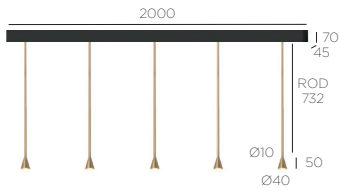

Position of the light fixture in the base can be adjusted

# Austere-D2 5 RF 75

230V - driver included in base - **LC** (TRIAC/IGBT) or **1-10** (1-10V) or **PU** (PUSH-DIM) or **DA** (DALI) dimmable  
 5 x LED array 6W (LED incl.) - 350mA - 5 x 634lm - 2700K - CRI >93  
 Shorter RF ROD available on demand. - **SUSPENSION** -

		FRAME brass	FRAME black	FRAME white	FRAME gunmetal	FRAME bronze	FRAME nickel	RETAIL PRICE VAT. EXCL.
	<b>DIM</b>							
black BASE	<b>LC</b>	AFLC 52273	AFLC 52272	AFLC 52271				2.795€
white BASE	<b>LC</b>	AFLC 52173	AFLC 52172	AFLC 52171				2.795€
black BASE	<b>LC</b>				AFLC 52274	AFLC 52277	AFLC 52279	3.310€
white BASE	<b>LC</b>				AFLC 52174	AFLC 52177	AFLC 52179	3.310€
black BASE	<b>1-10</b> <b>PU</b>	AFPU 52273	AFPU 52272	AFPU 52271				2.795€
white BASE	<b>1-10</b> <b>PU</b>	AFPU 52173	AFPU 52172	AFPU 52171				2.795€
black BASE	<b>1-10</b> <b>PU</b>				AFPU 52274	AFPU 52277	AFPU 52279	2.795€
white BASE	<b>1-10</b> <b>PU</b>				AFPU 52174	AFPU 52177	AFPU 52179	2.795€
black BASE	<b>PU</b> <b>DA</b>	AFDA 52273	AFDA 52272	AFDA 52271				2.795€
white BASE	<b>PU</b> <b>DA</b>	AFDA 52173	AFDA 52172	AFDA 52171				2.795€
black BASE	<b>PU</b> <b>DA</b>				AFDA 52274	AFDA 52277	AFDA 52279	2.795€
white BASE	<b>PU</b> <b>DA</b>				AFDA 52174	AFDA 52177	AFDA 52179	2.795€

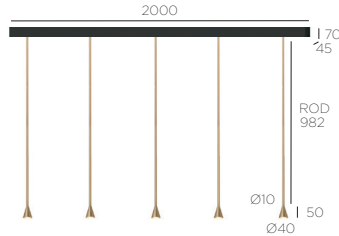

Position of the light fixture in the base can be adjusted

# Austere-D2 5 RF 100

230V - driver included in base - **LC** (TRIAC/IGBT) or **1-10** (1-10V) or **PU** (PUSH-DIM) or **DA** (DALI) dimmable  
 5 x LED array 6W (LED incl.) - 350mA - 5 x 634lm - 2700K - CRI >93  
 Shorter RF ROD available on demand. - **SUSPENSION** -

		FRAME brass	FRAME black	FRAME white	FRAME gunmetal	FRAME bronze	FRAME nickel	RETAIL PRICE VAT. EXCL.
	<b>DIM</b>							
black BASE	<b>LC</b>	AFLC 52293	AFLC 52292	AFLC 52291				2.845€
white BASE	<b>LC</b>	AFLC 52193	AFLC 52192	AFLC 52191				2.845€
black BASE	<b>LC</b>				AFLC 52294	AFLC 52297	AFLC 52299	3.360€
white BASE	<b>LC</b>				AFLC 52194	AFLC 52197	AFLC 52199	3.360€
black BASE	<b>1-10</b> <b>PU</b>	AFPU 52293	AFPU 52292	AFPU 52291				2.845€
white BASE	<b>1-10</b> <b>PU</b>	AFPU 52193	AFPU 52192	AFPU 52191				2.845€
black BASE	<b>1-10</b> <b>PU</b>				AFPU 52294	AFPU 52297	AFPU 52299	3.360€
white BASE	<b>1-10</b> <b>PU</b>				AFPU 52194	AFPU 52197	AFPU 52199	3.360€
black BASE	<b>PU</b> <b>DA</b>	AFDA 52293	AFDA 52292	AFDA 52291				2.845€
white BASE	<b>PU</b> <b>DA</b>	AFDA 52193	AFDA 52192	AFDA 52191				2.845€
black BASE	<b>PU</b> <b>DA</b>				AFDA 52294	AFDA 52297	AFDA 52299	3.360€
white BASE	<b>PU</b> <b>DA</b>				AFDA 52194	AFDA 52197	AFDA 52199	3.360€

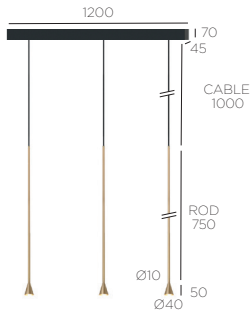

# Austere-D1 3 RL 79

230V - driver included in base - **LC** (TRIAC/IGBT) or **1-10** (1-10V) or **PU** (PUSH-DIM) or **DA** (DALI) dimmable  
 3 x LED array 6W (LED incl.) - 350mA - 3 x 634lm - 2700K - CRI >93  
 Longer cable lengths available on demand. - **SUSPENSION** -

Position of the light fixture in the base can be adjusted

		DIM		CABLE LENGTH		FRAME brass CABLE black		FRAME black CABLE black		FRAME white CABLE white		FRAME gunmetal CABLE black		FRAME bronze CABLE black		FRAME nickel CABLE black		RETAIL PRICE VAT. EXCL.
black BASE				L	1000	ALLC 31213	ALLC 31212	ALLC 31211										1.865€
white BASE				L	1000							ALLC 31214	ALLC 31217	ALLC 31219				2.165€
black BASE				L	1000	ALLC 31113	ALLC 31112	ALLC 31111										1.865€
white BASE				L	1000							ALLC 31114	ALLC 31117	ALLC 31119				2.165€
black BASE				L	1000	ALPU 31213	ALPU 31212	ALPU 31211										1.865€
white BASE				L	1000							ALPU 31214	ALPU 31217	ALPU 31219				2.165€
black BASE				L	1000	ALPU 31113	ALPU 31112	ALPU 31111										1.865€
white BASE				L	1000							ALPU 31114	ALPU 31117	ALPU 31119				2.165€
black BASE				L	1000	ALDA 31213	ALDA 31212	ALDA 31211										1.865€
white BASE				L	1000							ALDA 31214	ALDA 31217	ALDA 31219				2.165€
black BASE				L	1000	ALDA 31113	ALDA 31112	ALDA 31111										1.865€
white BASE				L	1000							ALDA 31114	ALDA 31117	ALDA 31119				2.165€

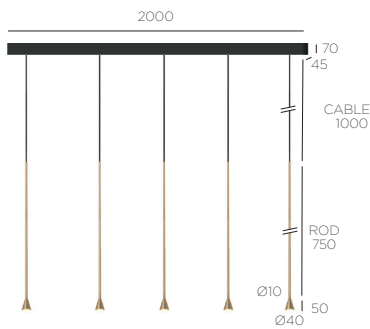

# Austere-D2 5 RL 79

230V - driver included in base - **LC** (TRIAC/IGBT) or **1-10** (1-10V) or **PU** (PUSH-DIM) or **DA** (DALI) dimmable  
 5 x LED array 6W (LED incl.) - 350mA - 5 x 634lm - 2700K - CRI >93  
 Longer cable lengths available on demand. - **SUSPENSION** -

Position of the light fixture in the base can be adjusted

		DIM		CABLE LENGTH		FRAME brass CABLE black		FRAME black CABLE black		FRAME white CABLE white		FRAME gunmetal CABLE black		FRAME bronze CABLE black		FRAME nickel CABLE black		RETAIL PRICE VAT. EXCL.
black BASE				L	1000	ALLC 52213	ALLC 52212	ALLC 52211										3.075€
white BASE				L	1000							ALLC 52214	ALLC 52217	ALLC 52219				3.585€
black BASE				L	1000	ALLC 52113	ALLC 52112	ALLC 52111										3.075€
white BASE				L	1000							ALLC 52114	ALLC 52117	ALLC 52119				3.585€
black BASE				L	1000	ALPU 52213	ALPU 52212	ALPU 52211										3.075€
white BASE				L	1000							ALPU 52214	ALPU 52217	ALPU 52219				3.585€
black BASE				L	1000	ALPU 52113	ALPU 52112	ALPU 52111										3.075€
white BASE				L	1000							ALPU 52114	ALPU 52117	ALPU 52119				3.585€
black BASE				L	1000	ALDA 52213	ALDA 52212	ALDA 52211										3.075€
white BASE				L	1000							ALDA 52214	ALDA 52217	ALDA 52219				3.585€
black BASE				L	1000	ALDA 52113	ALDA 52112	ALDA 52111										3.075€
white BASE				L	1000							ALDA 52114	ALDA 52117	ALDA 52119				3.585€

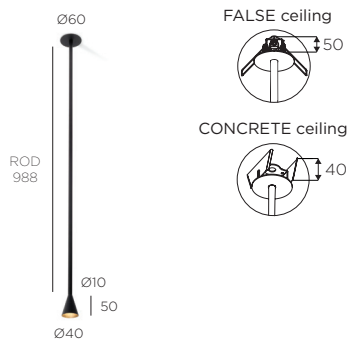

# Austere-Solitaire RF

RF = fixed vertical rod of max. 988mm (possibility to shorten with tube cutter)

350mA - **required remote mounted driver see below**

1 x LED array 6W (LED incl.) - 350mA - 634lm - 2700K - CRI >93

FALSE ceiling = aperture : Ø 45 - depth : min. 50 mm - depth for driver in ceiling : min. 70 mm

CONCRETE ceiling = aperture : Ø 45 - depth : min. 40 mm - depth for driver in ceiling : min. 110 mm

SUSPENSION -

	COVER brass FRAME brass	COVER black FRAME black	COVER white FRAME white	COVER gunmetal FRAME gunmetal	COVER bronze FRAME bronze	COVER nickel FRAME nickel	RETAIL PRICE VAT. EXCL.
FALSE ceiling	HVSU 1003	HVSU 1002	HVSU 1001				430€
FALSE ceiling				HVSU 1004	HVSU 1007	HVSU 1009	535€
CONCRETE ceiling	HVSC 1003	HVSC 1002	HVSC 1001				440€
CONCRETE ceiling				HVSC 1004	HVSC 1007	HVSC 1009	545€

## REQUIRED REMOTE MOUNTED DRIVER

DEVICE	DIM.	DRIVER	NET PRICE
1 x	LC (TRIAC/IGBT)	D 6WT	14€
2 x	LC (TRIAC/IGBT)	D 18WT	22€
1-2 x	PU (PUSH-DIM) + I-10 (1-10V)	D 15WP*	25€
1-2 x	DA (DALI)	D 15WDA EU	28€
1-2 x	DA (DALI)	D 15WDA US*	28€
2-6 x	PU (PUSH-DIM) + DA (DALI) + I-10 (1-10V)	D 40WDP*	57€

For warranty use only Trizo21® supplied LED drivers as mentioned.  
For all specs and techs about drivers, see [www.trizo21.com/drivers](http://www.trizo21.com/drivers)

driver remote mounting: driver does not fit through cutout hole of fixture  
\*110V-230V

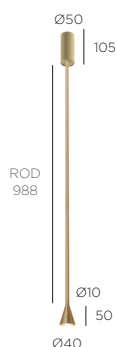

# Austere-Solitaire RF D+B

RF = fixed vertical rod of max. 988mm (possibility to shorten with tube cutter)

230V - driver included in base - LC (TRIAC/IGBT) dimmable

1 x LED array 6W (LED incl.) - 350mA - 634lm - 2700K - CRI >93

SUSPENSION -

	CANOPY brass FRAME brass	CANOPY black FRAME black	CANOPY white FRAME white	CANOPY gunmetal FRAME gunmetal	CANOPY bronze FRAME bronze	CANOPY nickel FRAME nickel	RETAIL PRICE VAT. EXCL.
DIM	HVSBD 1113	HVSBD 1112	HVSBD 1111				705€
LC				HVSBD 1114	HVSBD 1117	HVSBD 1119	830€

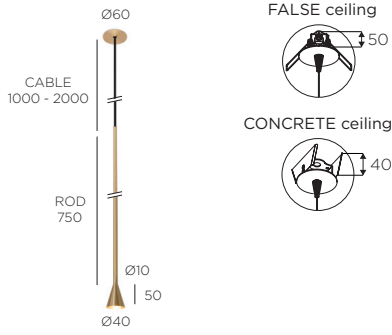

# Austere-Solitaire RL

RL = long vertical rod of 750 mm + powercord - Longer cable lengths available on demand.

350mA - **required remote mounted driver see below**

1 x LED array 6W (LED incl.) - 350mA - 634lm - 2700K - CRI >93

FALSE ceiling = aperture : Ø 45 - depth : min. 50 mm - depth for driver in ceiling : min. 70 mm

CONCRETE ceiling = aperture : Ø 45 - depth : min. 40 mm - depth for driver in ceiling : min. 110 mm

SUSPENSION -

	CABLE LENGTH	COVER CABLE FRAME							RETAIL PRICE VAT. EXCL.
FALSE ceiling	L 1000	brass black brass	HVCA 3013	HVCA 3012	HVCA 3011				480€
FALSE ceiling	L 2000		HVCA 3023	HVCA 3022	HVCA 3021				490€
FALSE ceiling	L 1000					HVCA 3014	HVCA 3017	HVCA 3019	590€
FALSE ceiling	L 2000					HVCA 3024	HVCA 3027	HVCA 3029	600€
CONCRETE ceiling	L 1000		HVCC 3013	HVCC 3012	HVCC 3011				490€
CONCRETE ceiling	L 2000		HVCC 3023	HVCC 3022	HVCC 3021				500€
CONCRETE ceiling	L 1000					HVCC 3014	HVCC 3017	HVCC 3019	590€
CONCRETE ceiling	L 2000					HVCC 3024	HVCC 3027	HVCC 3029	600€

## REQUIRED REMOTE MOUNTED DRIVER

DEVICE	DIM.	DRIVER	NET PRICE
1 x	LC (TRIAC/IGBT)	D 6WT	14€
2 x	LC (TRIAC/IGBT)	D 18WT	22€
1-2 x	PU (PUSH-DIM) + I-10 (1-10V)	D 15WP*	25€
1-2 x	DA (DALI)	D 15WDA EU	28€
1-2 x	DA (DALI)	D 15WDA US*	28€
2-6 x	PU (PUSH-DIM) + DA (DALI) + I-10 (1-10V)	D 40WDP*	57€

For warranty use only Trizo21® supplied LED drivers as mentioned.  
For all specs and techs about drivers, see [www.trizo21.com/drivers](http://www.trizo21.com/drivers)

driver remote mounting: driver does not fit through cutout hole of fixture  
\*110V-230V

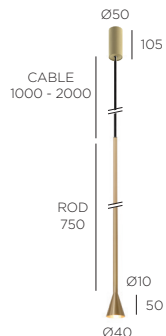

# Austere-Solitaire RL D+B

RL = long vertical rod of 750mm + powercord - Longer cable lengths available on demand.

230V - driver included in base - LC (TRIAC/IGBT) dimmable

1 x LED array 6W (LED incl.) - 350mA - 634lm - 2700K - CRI >93

SUSPENSION -

	CABLE LENGTH	CANOPY CABLE FRAME							RETAIL PRICE VAT. EXCL.
LC	L 1000	brass black brass	HVCBD 3313	HVCBD 3312	HVCBD 3311				745€
LC	L 2000		HVCBD 3323	HVCBD 3322	HVCBD 3321				755€
LC	L 1000					HVCBD 3314	HVCBD 3317	HVCBD 3319	880€
LC	L 2000					HVCBD 3324	HVCBD 3327	HVCBD 3329	890€

# DESIGN YOUR OWN AUSTERE-SUSPENSION - REMOTE MOUNTING

- I. Choose 1 x the CENTER length: 500 mm or 750 mm
- II. Choose 2 x the same END lengths: 250 mm or 500 mm
- III. Choose 4 x the same SIDE lengths: 250 mm or 500 mm

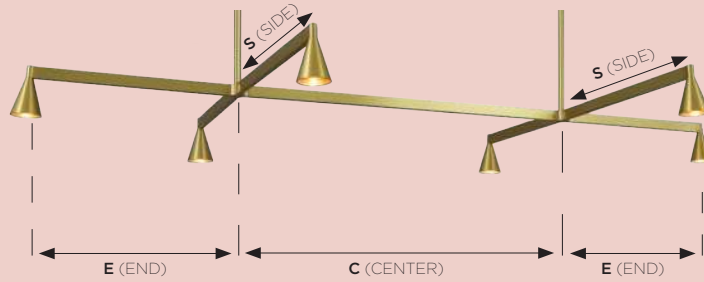

DIMENSIONS:

C 500 mm + 2 x E 250 mm + 4 x S 250 mm	Total size L: 1120 mm W: 590 mm
C 500 mm + 2 x E 250 mm + 4 x S 500 mm	Total size L: 1120 mm W: 1090 mm
C 500 mm + 2 x E 500 mm + 4 x S 250 mm	Total size L: 1620 mm W: 590 mm
C 500 mm + 2 x E 500 mm + 4 x S 500 mm	Total size L: 1620 mm W: 1090 mm
C 750 mm + 2 x E 250 mm + 4 x S 250 mm	Total size L: 1370 mm W: 590 mm
C 750 mm + 2 x E 250 mm + 4 x S 500 mm	Total size L: 1370 mm W: 1090 mm
C 750 mm + 2 x E 500 mm + 4 x S 250 mm	Total size L: 1870 mm W: 590 mm
C 750 mm + 2 x E 500 mm + 4 x S 500 mm	Total size L: 1870 mm W: 1090 mm

## IV. Choose the colors and the vertical ROD: RS 16, RL 79, RF 75 or RF 100

rod short: <b>RS 16</b>	rod long: <b>RL 79</b>	rod fixed: <b>RF 75</b>	rod fixed: <b>RF 100</b>
<p>CABLE +/-2000</p> <p><b>RS 16</b> ROD 160</p>	<p>CABLE +/-2000</p> <p><b>RL 79</b> ROD 790</p>	<p><b>RF 75</b> *ROD 750</p>	<p><b>RF 100</b> *ROD 1000</p>
<p>● FRAME</p> <p>● POWERCORD</p>	<p>● FRAME</p> <p>● POWERCORD</p>	<p>● FRAME</p>	<p>● FRAME</p>
		<p>*Total height depends on the chosen mounting option, see <b>NOTE</b> on product page.</p> <p>Shorter vertical rod available on demand with additional cost.</p>	<p>*Total height depends on the chosen mounting option, see <b>NOTE</b> on product page.</p> <p>Shorter vertical rod available on demand with additional cost.</p>

## V. Choose your cover or canopy for 'remote mounting' driver:

<p>Ø60 21</p> <p><b>cover C6</b></p> <p>aperture: Ø45</p> <p>DRIVER</p> <p>false/concrete ceiling</p> <p>For false ceiling: <b>RS 16, RL 79, RF 75 &amp; RF 100</b> For concrete ceiling: <b>RS 16 &amp; RL 79</b></p>	<p>Ø80 51</p> <p><b>cover C8</b></p> <p>aperture: Ø30 D50</p> <p>remote driver</p> <p>concrete ceiling</p> <p>For <b>RF 75 &amp; RF 100</b></p>	<p>Ø50 105</p> <p><b>canopy B10</b></p> <p>remote driver</p> <p>false/concrete ceiling</p> <p>For <b>RS 16, RL 79, RF 75 &amp; RF 100</b></p>	<p>Ø50 105</p> <p><b>canopy B11</b></p> <p>remote driver</p> <p>false/concrete ceiling</p> <p>For <b>RS 16 &amp; RL 79</b></p>
--	---	---	--

## VI. Choose your 'remote mounting' driver:

driver: non-dimmable

driver: 1-10V dimmable  
driver: PUSH-DIM dimmable  
driver: DALI dimmable

# DESIGN YOUR OWN AUSTERE-SUSPENSION - SURFACE MOUNTING

- I. Choose 1 x the CENTER length: 500 mm or 750 mm
- II. Choose 2 x the same END lengths: 250 mm or 500 mm
- III. Choose 4 x the same SIDE lengths: 250 mm or 500 mm

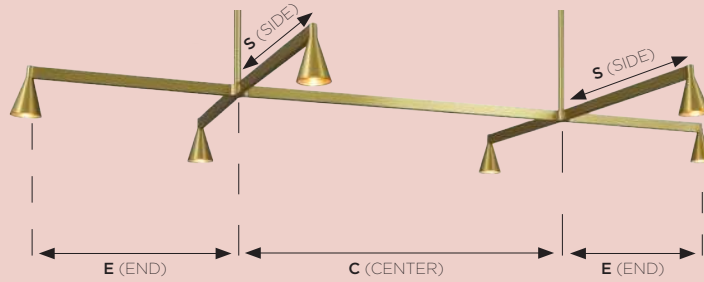

DIMENSIONS:

C 500 mm + 2 x E 250 mm + 4 x S 250 mm	Total size L: 1120 mm W: 590 mm
C 500 mm + 2 x E 250 mm + 4 x S 500 mm	Total size L: 1120 mm W: 1090 mm
C 500 mm + 2 x E 500 mm + 4 x S 250 mm	Total size L: 1620 mm W: 590 mm
C 500 mm + 2 x E 500 mm + 4 x S 500 mm	Total size L: 1620 mm W: 1090 mm
C 750 mm + 2 x E 250 mm + 4 x S 250 mm	Total size L: 1370 mm W: 590 mm
C 750 mm + 2 x E 250 mm + 4 x S 500 mm	Total size L: 1370 mm W: 1090 mm
C 750 mm + 2 x E 500 mm + 4 x S 250 mm	Total size L: 1870 mm W: 590 mm
C 750 mm + 2 x E 500 mm + 4 x S 500 mm	Total size L: 1870 mm W: 1090 mm

- IV. Choose the colors and the vertical ROD: RS 16 or RL 79

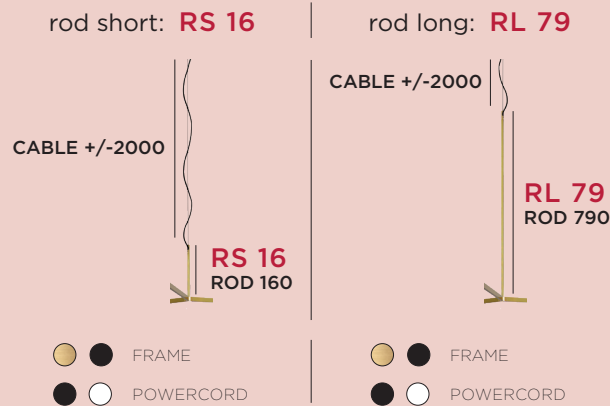

- V. Choose your base (driver incl.) for 'surface mounting':

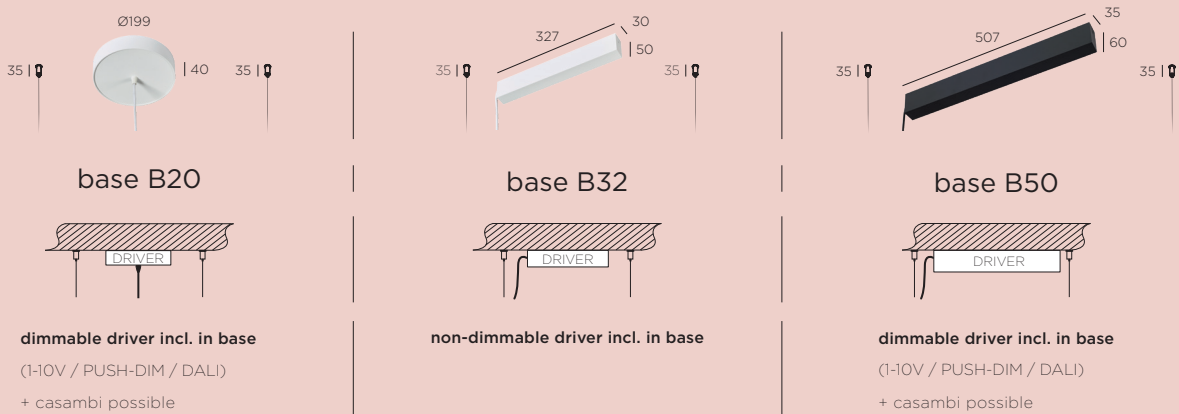

# Austere-Suspension 1+ RF 75 / RF 100

Shorter RF ROD available on demand.

350mA - **required remote mounted driver + required cover/canopy see below**

6 x LED array 6W (LED incl.) - 350mA - 6 x 634lm - 2700K - CRI >93

C (CENTER LENGTH), E (END LENGTH), S (SIDE LENGTH), **total dimensions see p. 101**

SUSPENSION -

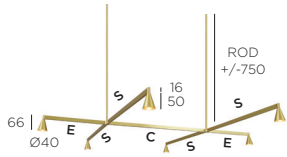

## 1+ RF 75

	CENTER LENGTH	END LENGTH	SIDE LENGTH	FRAME brass	FRAME black	RETAIL PRICE VAT. EXCL.
1x 500mm	1x 500mm	2x 250mm	4x 250mm	1+ SU RF7 52223	1+ SU RF7 52222	3.040€
1x 500mm	1x 500mm	2x 500mm	4x 250mm	1+ SU RF7 55223	1+ SU RF7 55222	3.060€
1x 750mm	1x 750mm	2x 250mm	4x 250mm	1+ SU RF7 72223	1+ SU RF7 72222	3.050€
1x 750mm	1x 750mm	2x 500mm	4x 250mm	1+ SU RF7 75223	1+ SU RF7 75222	3.075€

SIDE LENGTH 4x 500mm on demand  
gunmetal, bronze and nickel on demand

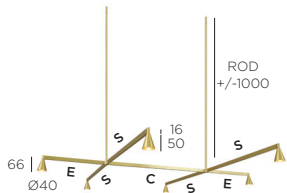

## 1+ RF 100

	CENTER LENGTH	END LENGTH	SIDE LENGTH	FRAME brass	FRAME black	RETAIL PRICE VAT. EXCL.
1x 500mm	1x 500mm	2x 250mm	4x 250mm	1+ SU RF10 52223	1+ SU RF10 52222	3.060€
1x 500mm	1x 500mm	2x 500mm	4x 250mm	1+ SU RF10 55223	1+ SU RF10 55222	3.080€
1x 750mm	1x 750mm	2x 250mm	4x 250mm	1+ SU RF10 72223	1+ SU RF10 72222	3.070€
1x 750mm	1x 750mm	2x 500mm	4x 250mm	1+ SU RF10 75223	1+ SU RF10 75222	3.095€

SIDE LENGTH 4x 500mm on demand  
gunmetal, bronze and nickel on demand

### REQUIRED COVER/CANOPY for Austere-Suspension 1+ RF 75 / RF 100 with REMOTE MOUNTED DRIVER

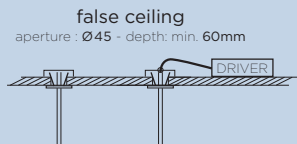

brass		22CO 3300	170€ (price incl. 2x C6)
black		22CO 2200	170€ (price incl. 2x C6)
white		22CO 1100	170€ (price incl. 2x C6)

**NOTE:** If the thickness of the false ceiling is 15mm, the total length of the suspension:  
**RF 75** with cover C6 will be **778mm**  
**RF 100** with cover C6 will be **1028mm**

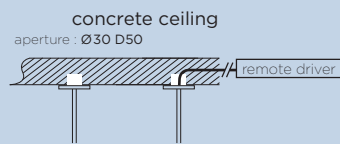

brass		22CO 8003	200€ (price incl. 2x C8)
black		22CO 8002	200€ (price incl. 2x C8)
white		22CO 8001	200€ (price incl. 2x C8)

**NOTE:** the total length of the suspension:  
**RF 75** with cover C8 will be **806mm**  
**RF 100** with cover C8 will be **1056mm**

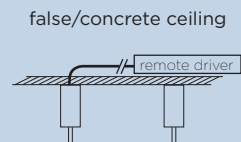
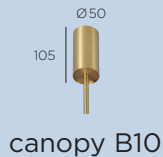

brass		22CP 3333	560€ (price incl. 2x B10)
black		22CP 2222	560€ (price incl. 2x B10)
white		22CP 1111	560€ (price incl. 2x B10)

**NOTE:** the total length of the suspension:  
**RF 75** with canopy B10 will be **906mm**  
**RF 100** with canopy B10 will be **1156mm**

### REQUIRED REMOTE MOUNTED DRIVER for Austere-Suspension 1+ RF 75 / RF 100

DEVICE	DIM.	DRIVER	NET PRICE
1 x	NO (non-dimmable)	N 50W*	29€
1 x	PU (PUSH-DIM) + 1-10 (1-10V)	D 80WP*	45€
1 x	PU (PUSH-DIM) + DA (DALI)	D 80WD*	51€

\*driver only fits through cutout hole of fixture with C6, min. depth for driver in false ceiling: 280mm

For warranty use only Trizo21® supplied LED drivers as mentioned. For all specs and techs about drivers, see [www.trizo21.com/drivers](http://www.trizo21.com/drivers)

# Austere-Suspension 1+ RS 16 / RL 79

350mA - **required remote mounted driver + required cover/canopy see below**

6 x LED array 6W (LED incl.) - 350mA - 6 x 634lm - 2700K - CRI >93

**C** (CENTER LENGTH), **E** (END LENGTH), **S** (SIDE LENGTH), **total dimensions see p. 101**

**SUSPENSION** -

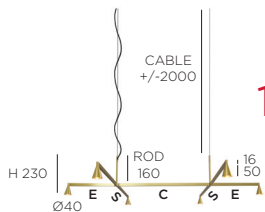

## 1+ RS 16

CENTER LENGTH	END LENGTH	SIDE LENGTH	FRAME brass	POWERCORD black	STEELCABLE black	FRAME black	POWERCORD black	STEELCABLE black	FRAME brass	POWERCORD white	STEELCABLE silver	RETAIL PRICE VAT. EXCL.
1x 500mm	2x 250mm	4x 250mm										3.060€
1x 500mm	2x 500mm	4x 250mm										3.080€
1x 750mm	2x 250mm	4x 250mm										3.070€
1x 750mm	2x 500mm	4x 250mm										3.095€

SIDE LENGTH 4x 500mm on demand  
gunmetal, bronze and nickel on demand

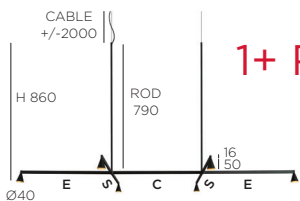

## 1+ RL 79

CENTER LENGTH	END LENGTH	SIDE LENGTH	FRAME brass	POWERCORD black	STEELCABLE black	FRAME black	POWERCORD black	STEELCABLE black	FRAME brass	POWERCORD white	STEELCABLE silver	RETAIL PRICE VAT. EXCL.
1x 500mm	2x 250mm	4x 250mm										3.140€
1x 500mm	2x 500mm	4x 250mm										3.160€
1x 750mm	2x 250mm	4x 250mm										3.150€
1x 750mm	2x 500mm	4x 250mm										3.175€

SIDE LENGTH 4x 500mm on demand  
gunmetal, bronze and nickel on demand

### REQUIRED COVER/CANOPY for Austere-Suspension 1+ RS 16 / RL 79 with REMOTE MOUNTED DRIVER



cover C6

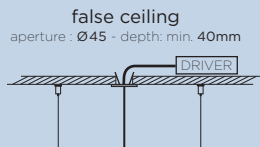

brass	21CO 0003	85€
black	21CO 0002	85€
white	21CO 0001	85€



cover C6

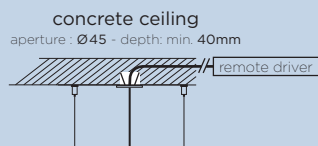

brass	21CO 0013	105€
black	21CO 0012	105€
white	21CO 0011	105€

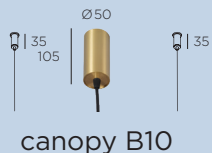

canopy B10

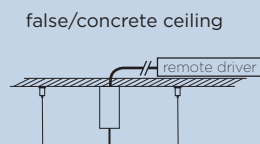

brass	21CP 3003	280€
black	21CP 2002	280€
white	21CP 1001	280€

### REQUIRED REMOTE MOUNTED DRIVER for Austere-Suspension 1+ RS 16 / RL 79

DEVICE	DIM.	DRIVER	NET PRICE
1 x	NO (non-dimmable)	N 50W •	29€
1 x	PU (PUSH-DIM) + 1-10 (1-10V)	D 80WP •	45€
1 x	PU (PUSH-DIM) + DA (DALI)	D 80WD •	51€

• driver only fits through cutout hole of fixture with C6, min. depth for driver in false ceiling: 280mm  
For warranty use only Trizo21® supplied LED drivers as mentioned. For all specs and techs about drivers, see [www.trizo21.com/drivers](http://www.trizo21.com/drivers)



# Austere-Suspension 1+ RS 16 / RL 79

350mA - **required base (driver incl.) see below**

6 x LED array 6W (LED incl.) - 350mA - 6 x 634lm - 2700K - CRI >93

**C** (CENTER LENGTH), **E** (END LENGTH), **S** (SIDE LENGTH), **total dimensions see p. 102**

**SUSPENSION** -

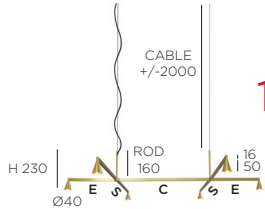

## 1+ RS 16

CENTER LENGTH	END LENGTH	SIDE LENGTH	FRAME brass			FRAME black			FRAME brass			RETAIL PRICE VAT: EXCL.
			POWERCORD black	STEELCABLE black	POWERCORD black	STEELCABLE black	POWERCORD white	STEELCABLE silver				
1x 500mm	2x 250mm	4x 250mm	1+ SU RS 52223	1+ SU RS 52222	1+ SU RS 52213	3.060€						
1x 500mm	2x 500mm	4x 250mm	1+ SU RS 55223	1+ SU RS 55222	1+ SU RS 55213	3.080€						
1x 750mm	2x 250mm	4x 250mm	1+ SU RS 72223	1+ SU RS 72222	1+ SU RS 72213	3.070€						
1x 750mm	2x 500mm	4x 250mm	1+ SU RS 75223	1+ SU RS 75222	1+ SU RS 75213	3.095€						

SIDE LENGTH 4x 500mm on demand  
gunmetal, bronze and nickel on demand

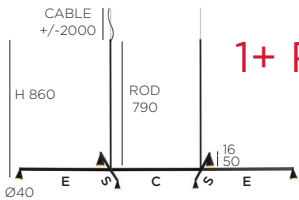

## 1+ RL 79

CENTER LENGTH	END LENGTH	SIDE LENGTH	FRAME brass			FRAME black			FRAME brass			RETAIL PRICE VAT: EXCL.
			POWERCORD black	STEELCABLE black	POWERCORD black	STEELCABLE black	POWERCORD white	STEELCABLE silver				
1x 500mm	2x 250mm	4x 250mm	1+ SU RL 52223	1+ SU RL 52222	1+ SU RL 52213	3.140€						
1x 500mm	2x 500mm	4x 250mm	1+ SU RL 55223	1+ SU RL 55222	1+ SU RL 55213	3.160€						
1x 750mm	2x 250mm	4x 250mm	1+ SU RL 72223	1+ SU RL 72222	1+ SU RL 72213	3.150€						
1x 750mm	2x 500mm	4x 250mm	1+ SU RL 75223	1+ SU RL 75222	1+ SU RL 75213	3.175€						

SIDE LENGTH 4x 500mm on demand  
gunmetal, bronze and nickel on demand

### REQUIRED BASE (DRIVER INCL.) for Austere-Suspension 1+ RS 16 / RL 79

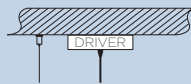

black		1-10 PU DA	BCDP 2402	320€	110V-230V - <b>driver included in base</b> + casambi possible
white		1-10 PU DA	BCDP 2401	320€	
optional: <b>casambi</b>			D CAS	95€ (NET PRICE)	

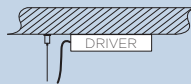
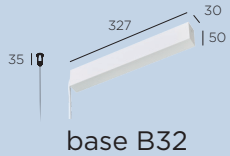

black		NO	BNDN 0822	455€	230V - <b>driver included in base</b>
white		NO	BNDN 0811	455€	

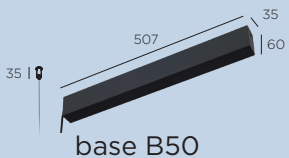

black		1-10 PU	BDPU 0822	555€	230V - <b>driver included in base</b> + casambi possible
white		1-10 PU	BDPU 0811	555€	
black		DA PU	BDDA 0822	590€	
white		DA PU	BDDA 0811	590€	
optional: <b>casambi</b>			D CAS	95€ (NET PRICE)	

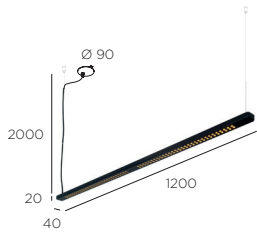

# I-Tro

24Vdc - **required remote mounted driver see below**

1 lighting side : 120 x SMD LED 30W **(LED incl.)** - 24Vdc - 2280lm - 2850K - CRI >90  
 2 lighting sides : 240 x SMD LED 60W **(LED incl.)** - 24Vdc - 4560lm - 2850K - CRI >90  
 depth for driver in ceiling : min. 120 mm

SUSPENSION -

FRAME black



FRAME white



RETAIL PRICE  
VAT. EXCL.

1 side	ITRO 1111	ITRO 2211	1.170€
2 sides	ITRO 1122	ITRO 2222	1.715€

## REQUIRED REMOTE MOUNTED DRIVER

DEVICE	DIM.	DRIVER	NET PRICE
1 x 1 side	(1-10V)	D 40W10*	46€
1 x 2 sides	(1-10V)	D 60W10*	60€
2 x 1 side	(1-10V)	D 60W10*	60€

\*110V-230V

For warranty use only Trizo21® supplied LED drivers as mentioned.  
 For all specs and techs about drivers, see [www.trizo21.com/drivers](http://www.trizo21.com/drivers)

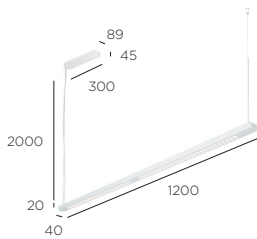

# I-Tro D+B

100V-240V - **driver included in base** - (1-10V) dimmable

1 lighting side : 120 x SMD LED 30W **(LED incl.)** - 24Vdc - 2280lm - 2850K - CRI >90  
 2 lighting sides : 240 x SMD LED 60W **(LED incl.)** - 24Vdc - 4560lm - 2850K - CRI >90

SUSPENSION -

FRAME black



FRAME white



RETAIL PRICE  
VAT. EXCL.

1 side		ITRO 1101	ITRO 2201	1.380€
2 sides		ITRO 1102	ITRO 2202	1.925€

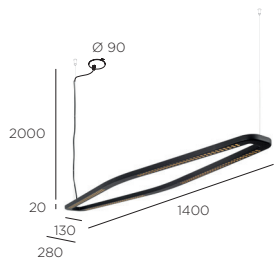

# N-Tro

24Vdc - **required remote mounted driver see below**

240 x SMD LED 60W (LED incl.) - 24Vdc - 4560lm - 2850K - CRI >90

depth for driver in ceiling : min. 120 mm

SUSPENSION -

● FRAME black

○ FRAME white

RETAIL PRICE  
VAT. EXCL.

NTRO 1111

NTRO 2222 | 2.480€

## REQUIRED REMOTE MOUNTED DRIVER

DEVICE	DIM.	DRIVER	NET PRICE
1 x	(1-10V)	D 60W10* *110V-230V	60€

For warranty use only Trizo21® supplied LED drivers as mentioned.  
For all specs and techs about drivers, see [www.trizo21.com/drivers](http://www.trizo21.com/drivers)

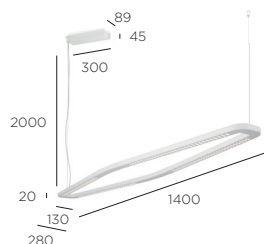

# N-Tro D+B

100V-240V - **driver included in base** - (1-10V) dimmable

240 x SMD LED 60W (LED incl.) - 24Vdc - 4560lm - 2850K - CRI >90

SUSPENSION -

● FRAME black

○ FRAME white

RETAIL PRICE  
VAT. EXCL.

| NTRO 1000

NTRO 2000 | 2.825€

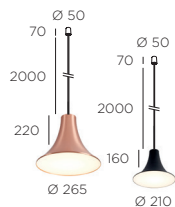

# Sirens SU diffuser glass

110V-230V

E27 - only energy saving bulbs (LED or FLUO)

bulb size for Ø 210: max. Ø 45 mm L: 115mm, for Ø 265: max. Ø 60mm L: 175mm

LED or FLUO bulb excluded - SUSPENSION -

	FRAME black	FRAME white	FRAME copper	RETAIL PRICE VAT. EXCL.
Ø 210	SISU 2112	SISU 2111		445€
Ø 265	SISU 2612	SISU 2611		525€
Ø 210			SISU 2117	485€
Ø 265			SISU 2617	555€

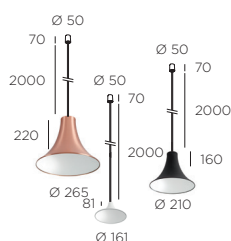

# Sirens SU mirror

SUSPENSION

	FRAME black	FRAME white	FRAME copper	RETAIL PRICE VAT. EXCL.
Ø 161	SISU 1602	SISU 1601		245€
Ø 210	SISU 2102	SISU 2101		345€
Ø 265	SISU 2602	SISU 2601		405€
Ø 161			SISU 1607	285€
Ø 210			SISU 2107	385€
Ø 265			SISU 2607	445€

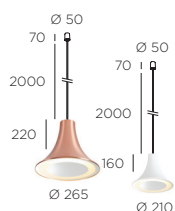

# Sirens SU frosted glass big mirror + edge mirror

110V-230V

E27 - only energy saving bulbs (LED or FLUO)

bulb size for Ø 210: max. Ø 45 mm L: 115mm, for Ø 265: max. Ø 60mm L: 175mm

LED or FLUO bulb excluded - SUSPENSION -

	FRAME black	FRAME white	FRAME copper	RETAIL PRICE VAT. EXCL.
Ø 210	SISU 2122	SISU 2121		420€
Ø 265	SISU 2622	SISU 2621		480€
Ø 210			SISU 2127	455€
Ø 265			SISU 2627	515€



# Sirens SU frosted glass small mirror + edge mirror

110V-230V

E27 - only energy saving bulbs (LED or FLUO)

bulb size for Ø 210: max. Ø 45 mm L: 115mm, for Ø 265: max. Ø 60mm L: 175mm

LED or FLUO bulb excluded - SUSPENSION -

	FRAME black	FRAME white	FRAME copper	RETAIL PRICE VAT. EXCL.
Ø 210	SISU 2132	SISU 2131		420€
Ø 265	SISU 2632	SISU 2631		480€
Ø 210			SISU 2137	455€
Ø 265			SISU 2637	515€

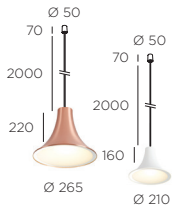

# Sirens SU frosted glass edge mirror

110V-230V

E27 - only energy saving bulbs (LED or FLUO)

bulb size for Ø 210: max. Ø 45 mm L: 115mm, for Ø 265: max. Ø 60mm L: 175mm

LED or FLUO bulb excluded - SUSPENSION -

	FRAME black	FRAME white	FRAME copper	RETAIL PRICE VAT. EXCL.
Ø 210	SISU 2142	SISU 2141		420€
Ø 265	SISU 2642	SISU 2641		480€
Ø 210			SISU 2147	455€
Ø 265			SISU 2647	515€

# Recessed



## AUDETTE

Audette in	116
Audette-Duo in	117
Audette-Varié in	118

---



## AUST-IN

Aust-In	122
Aust-In Adjustable	122

---

## 2THIRTY

2Thirty-C1 in	112
2Thirty-C1 in 350mA	112
2Thirty-C2 in	113
2Thirty-C2 in 350mA	113
2Thirty-W1 in	114
2Thirty-W1 in 350mA	114

---



## BILY

Bily 16 in	123
------------	-----

---



## AUDETTE R6

Audette R6	119
Audette-Duo R6	120

---



## 7TY

7Ty in	115
--------	-----

---



## AUDY

Audy-In	121
---------	-----

---



## BOULY

Bouly 4	124
Bouly 16	124

---

# Recessed



## MINI-PI

Mini-PI 1 in	125
Mini-PI 2 in	125



## R5 IN

R51 in GU10	127
R52 in GU10	127
R54 in GU10	128
R51 in LED	129
R51 Rimless LED	129
R52 in LED	130
R52 Rimless LED	130
R54 in LED	131
R54 Rimless LED	131



## PIN-IN

Pin-In 1	126
Pin-In 2	126



## R110 / R111 IN

R110 in G53	134
R110 Rimless	134
R111 in G53	135
R111 Rimless	135



## R07 / R70 IN

R07 in	132
R07 Rimless	132
R70 in	133
R70 Rimless	133

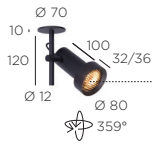

Choose beam:  
 N=narrow 12° or  
 M=medium 24° or  
 W=wide 40°

# 2Thirty-C1 in

230V (110V on demand)  
 1 x LED module 10W (LED incl.) - 230V - 1000lm - 2700K - CRI >90 - TRIAC dimmable  
 CEILING -

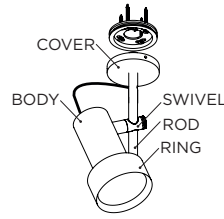

ROD + COVER black  
 BODY black  
 SWIVEL black  
 RING black

ROD + COVER black  
 BODY black  
 SWIVEL black  
 RING bronze

ROD + COVER black  
 BODY black  
 SWIVEL black  
 RING gold

RETAIL PRICE  
 VAT. EXCL.

| THIN 12223 ◆ THIN 17223 ◆ THIN 18223 ◆ | 480€

+ honeycomb | THIN 12223H ◆ THIN 17223H ◆ THIN 18223H ◆ | 500€



Choose beam:  
 N=narrow 12° or  
 M=medium 24° or  
 W=wide 40°

# 2Thirty-C1 in 350mA

350mA - **required remote mounted driver see below**  
 1 x LED array 11,8W (LED incl.) - 350mA - 1241lm - 2700K - CRI >97 - dimmable  
 CEILING -

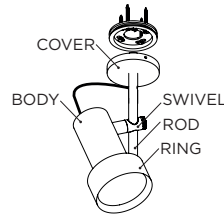

ROD + COVER black  
 BODY black  
 SWIVEL black  
 RING black

ROD + COVER black  
 BODY black  
 SWIVEL black  
 RING bronze

ROD + COVER black  
 BODY black  
 SWIVEL black  
 RING gold

RETAIL PRICE  
 VAT. EXCL.

| TH3N 12223 ◆ TH3N 17223 ◆ TH3N 18223 ◆ | 375€

+ honeycomb | TH3N 12223H ◆ TH3N 17223H ◆ TH3N 18223H ◆ | 395€

## REQUIRED REMOTE MOUNTED DRIVER

DEVICE	DIM.
1 x	LC (TRIAC/IGBT)
1 x	PU (PUSH-DIM) + DA (DALI)
1 x	DA (DALI)
1 x	DA (DALI)
1-3 x	PU (PUSH-DIM) + DA (DALI) + I10 (1-10V)

DRIVER	NET PRICE
D 18WT	22€
D 15WP*	25€
D 15WDA EU	28€
D 15WDA US*	28€
D 40WDP*	57€

For warranty use only Trizo21® supplied LED drivers as mentioned.  
 For all specs and techs about drivers, see [www.trizo21.com/drivers](http://www.trizo21.com/drivers)

driver remote mounting: driver does not fit through cutout hole of fixture  
 \*110V-230V



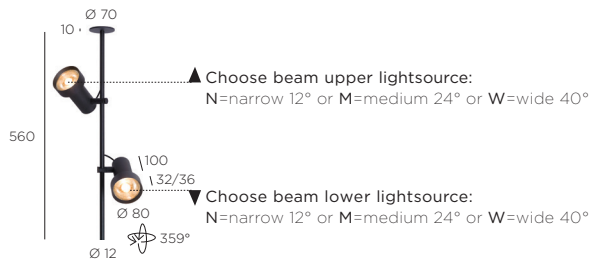

# 2Thirty-C2 in

230V (110V on demand)  
 2 x LED module 10W (LED incl.) - 230V - 2 x 1000lm - 2700K - CRI >90 - TRIAC dimmable  
 CEILING -

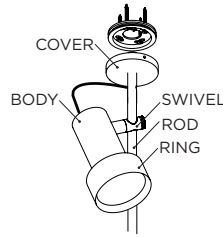

- ROD + COVER black
- BODY black
- SWIVEL black
- RING black

- ROD + COVER black
- BODY black
- SWIVEL black
- RING bronze

- ROD + COVER black
- BODY black
- SWIVEL black
- RING gold

RETAIL PRICE  
 VAT. EXCL.

| THIN 22223 ▲▼ | THIN 27223 ▲▼ | THIN 28223 ▲▼ | 845€

+ honeycomb | THIN 22223H ▲▼ | THIN 27223H ▲▼ | THIN 28223H ▲▼ | 885€

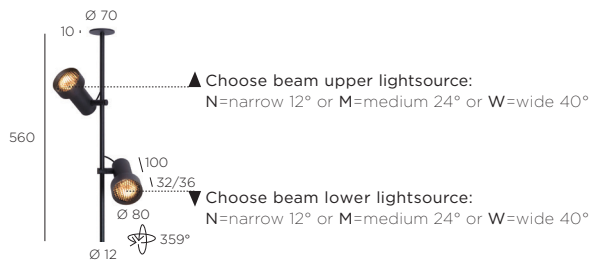

# 2Thirty-C2 in 350mA

350mA - required remote mounted driver see below  
 2 x LED array 11,8W (LED incl.) - 350mA - 2 x 1241lm - 2700K - CRI >97 - dimmable  
 CEILING -

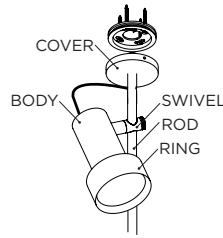

- ROD + COVER black
- BODY black
- SWIVEL black
- RING black

- ROD + COVER black
- BODY black
- SWIVEL black
- RING bronze

- ROD + COVER black
- BODY black
- SWIVEL black
- RING gold

RETAIL PRICE  
 VAT. EXCL.

| TH3N 22223 ▲▼ | TH3N 27223 ▲▼ | TH3N 28223 ▲▼ | 740€

+ honeycomb | TH3N 22223H ▲▼ | TH3N 27223H ▲▼ | TH3N 28223H ▲▼ | 780€

## REQUIRED REMOTE MOUNTED DRIVER

DEVICE	DIM.	DRIVER	NET PRICE
1 x	PU (PUSH-DIM) + DA (DALI) + HO (1-10V)	D 40WDP*	57€

For warranty use only Trizo21® supplied LED drivers as mentioned.  
 For all specs and techs about drivers, see [www.trizo21.com/drivers](http://www.trizo21.com/drivers)

driver remote mounting; driver does not fit through cutout hole of fixture  
 \*110V-230V



Choose beam:  
 N=narrow 12° or  
 M=medium 24° or  
 W=wide 40°

# 2Thirty-W1 in

230V (110V on demand)  
 1 x LED module 10W (LED incl.) - 230V - 1000lm - 2700K - CRI >90 - TRIAC dimmable  
 WALL -

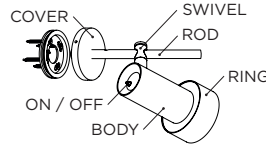

- ROD + COVER black
- BODY black
- SWIVEL black
- RING black

- ROD + COVER black
- BODY black
- SWIVEL black
- RING bronze

- ROD + COVER black
- BODY black
- SWIVEL black
- RING gold

RETAIL PRICE  
 VAT. EXCL.

| TWIN 12223 ◆ | TWIN 17223 ◆ | TWIN 18223 ◆ | 480€

+ honeycomb | TWIN 12223H ◆ | TWIN 17223H ◆ | TWIN 18223H ◆ | 500€



Choose beam:  
 N=narrow 12° or  
 M=medium 24° or  
 W=wide 40°

# 2Thirty-W1 in 350mA

350mA - **required remote mounted driver see below** - PUSH-DIM on armature  
 1 x LED array 11,8W (LED incl.) - 350mA - 1241lm - 2700K - CRI >97 - dimmable  
 WALL -

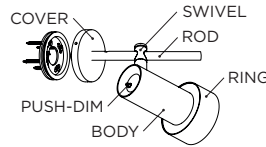

- ROD + COVER black
- BODY black
- SWIVEL black
- RING black

- ROD + COVER black
- BODY black
- SWIVEL black
- RING bronze

- ROD + COVER black
- BODY black
- SWIVEL black
- RING gold

RETAIL PRICE  
 VAT. EXCL.

| TW3N 12223 ◆ | TW3N 17223 ◆ | TW3N 18223 ◆ | 375€

+ honeycomb | TW3N 12223H ◆ | TW3N 17223H ◆ | TW3N 18223H ◆ | 395€

## REQUIRED REMOTE MOUNTED DRIVER

DEVICE	DIM.
1 x	PU (PUSH-DIM)

DRIVER	NET PRICE
D 15WPLV*	32€

For warranty use only Trizo21® supplied LED drivers as mentioned.  
 For all specs and techs about drivers, see [www.trizo21.com/drivers](http://www.trizo21.com/drivers)

driver remote mounting: driver does not fit through cutout hole of fixture  
 \*110V-230V



FALSE & CONCRETE ceiling



# 7Ty in

◆ Choose beam:

- N=narrow 12° or
- M=medium 24° or
- W=wide 40°

350mA - **required remote mounted driver see below**

1 x LED array 11,8W (**LED incl.**) - 350mA - 1241lm - 2700K - CRI >97

aperture : Ø 60mm - depth : min. 65 mm

CEILING -

	FRAME black	FRAME white	FRAME bronze	FRAME gold	FRAME alu	RETAIL PRICE VAT. EXCL.
	◆	○	●	●	○	
	STIN 1002◆	STIN 1001◆	STIN 1007◆	STIN 1008◆	STIN 1009◆	235€
+ honeycomb	STIN 1002H◆	STIN 1001H◆	STIN 1007H◆	STIN 1008H◆	STIN 1009H◆	245€

## REQUIRED REMOTE MOUNTED DRIVER

DEVICE	DIM.	DRIVER	NET PRICE
1 x	LC (TRIAC/IGBT)	D 18WT	22€
1 x	PU (PUSH-DIM) + DA (DALI)	D 15WP*	25€
1 x	DA (DALI)	D 15WDA EU	28€
1 x	DA (DALI)	D 15WDA US*	28€
1-3 x	PU (PUSH-DIM) + DA (DALI) + I10 (1-10V)	D 40WDP*	57€

For warranty use only Trizo21® supplied LED drivers as mentioned.  
For all specs and techs about drivers, see [www.trizo21.com/drivers](http://www.trizo21.com/drivers)

driver remote mounting: driver does not fit through cutout hole of fixture  
\*110V-230V

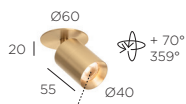

Choose beam:  
M=medium 23°  
or W=wide 40°

FALSE ceiling



CONCRETE ceiling



# Audette in

350mA - **required remote mounted driver see below**

1 x LED array 6.25W (LED incl.) - 350mA - 2700K (633lm) or 3000K (673lm) - CRI >95

FALSE ceiling = aperture : Ø 45 - depth : min. 50 mm - depth for driver in ceiling : min. 70 mm

CONCRETE ceiling = aperture : Ø 45 - depth : min. 40 mm - depth for driver in ceiling : min. 110 mm

CEILING -

		COLOR LED	COVER brass SWIVEL brass BODY brass RING brass	COVER black SWIVEL black BODY black RING black	COVER white SWIVEL white BODY white RING white	COVER gunmetal SWIVEL gunmetal BODY gunmetal RING gunmetal	COVER bronze SWIVEL bronze BODY bronze RING bronze	COVER nickel SWIVEL nickel BODY nickel RING nickel	RETAIL PRICE VAT. EXCL.
FALSE ceiling		2700K	ADFC 2333						340€
FALSE ceiling		2700K		ADFC 2222	ADFC 2111				315€
FALSE ceiling		2700K				ADFC 2444	ADFC 2777	ADFC 2999	405€
FALSE ceiling		3000K	ADFC 3333						340€
FALSE ceiling		3000K		ADFC 3222	ADFC 3111				315€
FALSE ceiling		3000K				ADFC 3444	ADFC 3777	ADFC 3999	405€
FALSE ceiling	+ honeycomb	2700K	ADFC 2333H						350€
FALSE ceiling	+ honeycomb	2700K		ADFC 2222H	ADFC 2111H				325€
FALSE ceiling	+ honeycomb	2700K				ADFC 2444H	ADFC 2777H	ADFC 2999H	415€
FALSE ceiling	+ honeycomb	3000K	ADFC 3333H						350€
FALSE ceiling	+ honeycomb	3000K		ADFC 3222H	ADFC 3111H				325€
FALSE ceiling	+ honeycomb	3000K				ADFC 3444H	ADFC 3777H	ADFC 3999H	415€
CONCRETE ceiling		2700K	ADCC 2333						350€
CONCRETE ceiling		2700K		ADCC 2222	ADCC 2111				325€
CONCRETE ceiling		2700K				ADCC 2444	ADCC 2777	ADCC 2999	415€
CONCRETE ceiling		3000K	ADCC 3333						350€
CONCRETE ceiling		3000K		ADCC 3222	ADCC 3111				325€
CONCRETE ceiling		3000K				ADCC 3444	ADCC 3777	ADCC 3999	415€
CONCRETE ceiling	+ honeycomb	2700K	ADCC 2333H						360€
CONCRETE ceiling	+ honeycomb	2700K		ADCC 2222H	ADCC 2111H				335€
CONCRETE ceiling	+ honeycomb	2700K				ADCC 2444H	ADCC 2777H	ADCC 2999H	425€
CONCRETE ceiling	+ honeycomb	3000K	ADCC 3333H						360€
CONCRETE ceiling	+ honeycomb	3000K		ADCC 3222H	ADCC 3111H				335€
CONCRETE ceiling	+ honeycomb	3000K				ADCC 3444H	ADCC 3777H	ADCC 3999H	425€

## REQUIRED REMOTE MOUNTED DRIVER

DEVICE	DIM.
1 x	LC (TRIAC/IGBT)
2 x	LC (TRIAC/IGBT)
1-2 x	PU (PUSH-DIM) + DA (DALI)
1-2 x	DA (DALI)
1-2 x	DA (DALI)
2-6 x	PU (PUSH-DIM) + DA (DALI) + I10 (1-10V)

DRIVER	NET PRICE
D 6WT	14€
D 18WT	22€
D 15WP*	25€
D 15WDA EU	28€
D 15WDA US*	28€
D 40WDP*	54€

For warranty use only Trizo21® supplied LED drivers as mentioned.  
For all specs and techs about drivers, see [www.trizo21.com/drivers](http://www.trizo21.com/drivers)

driver remote mounting; driver does not fit through cutout hole of fixture  
\*110V-230V

# Audette-Duo in

350mA - **required remote mounted driver see below**

1 x LED array 6.25W (LED incl.) - 350mA - 2700K (633lm) or 3000K (673lm) - CRI >95

**FALSE ceiling** = aperture : Ø 45 - depth : min. 50 mm - depth for driver in ceiling : min. 70 mm

**CONCRETE ceiling** = aperture : Ø 45 - depth : min. 40 mm - depth for driver in ceiling : min. 110 mm

CEILING -

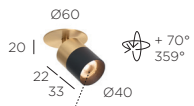

Choose beam:  
M=medium 23°  
or W=wide 40°

FALSE ceiling



CONCRETE ceiling



		COLOR LED	COVER brass	SWIVEL brass	BODY brass	RING black	COVER brass	SWIVEL brass	BODY brass	RING white	COVER black	SWIVEL black	BODY black	RING brass	COVER white	SWIVEL white	BODY white	RING brass	RETAIL PRICE VAT. EXCL.
FALSE ceiling		2700K	●	●	●	●	●	●	●	○	●	●	●	●	○	○	○	●	315€
FALSE ceiling		2700K									●	●	●	●	○	○	○	●	340€
FALSE ceiling		3000K	●	●	●	●	●	●	●	○	●	●	●	●	○	○	○	●	315€
FALSE ceiling		3000K									●	●	●	●	○	○	○	●	340€
FALSE ceiling	+ honeycomb	2700K	●	●	●	●	●	●	●	○	●	●	●	●	○	○	○	●	325€
FALSE ceiling	+ honeycomb	2700K									●	●	●	●	○	○	○	●	350€
FALSE ceiling	+ honeycomb	3000K	●	●	●	●	●	●	●	○	●	●	●	●	○	○	○	●	325€
FALSE ceiling	+ honeycomb	3000K									●	●	●	●	○	○	○	●	350€
CONCRETE ceiling		2700K	●	●	●	●	●	●	●	○	●	●	●	●	○	○	○	●	325€
CONCRETE ceiling		2700K									●	●	●	●	○	○	○	●	350€
CONCRETE ceiling		3000K	●	●	●	●	●	●	●	○	●	●	●	●	○	○	○	●	325€
CONCRETE ceiling		3000K									●	●	●	●	○	○	○	●	350€
CONCRETE ceiling	+ honeycomb	2700K	●	●	●	●	●	●	●	○	●	●	●	●	○	○	○	●	335€
CONCRETE ceiling	+ honeycomb	2700K									●	●	●	●	○	○	○	●	360€
CONCRETE ceiling	+ honeycomb	3000K	●	●	●	●	●	●	●	○	●	●	●	●	○	○	○	●	335€
CONCRETE ceiling	+ honeycomb	3000K									●	●	●	●	○	○	○	●	360€

## REQUIRED REMOTE MOUNTED DRIVER

DEVICE	DIM.	DRIVER	NET PRICE
1 x	LC (TRIAC/IGBT)	D 6WT	14€
2 x	LC (TRIAC/IGBT)	D 18WT	22€
1-2 x	PU (PUSH-DIM) + DA (DALI)	D 15WP*	25€
1-2 x	DA (DALI)	D 15WDA EU	28€
1-2 x	DA (DALI)	D 15WDA US*	28€
2-6 x	PU (PUSH-DIM) + DA (DALI) + I10 (1-10V)	D 40WDP*	54€

For warranty use only Trizo21® supplied LED drivers as mentioned.  
For all specs and techs about drivers, see [www.trizo21.com/drivers](http://www.trizo21.com/drivers)

driver remote mounting: driver does not fit through cutout hole of fixture  
\*110V-230V



Choose beam:  
M=medium 23°  
or W=wide 40°

FALSE ceiling



CONCRETE ceiling



# Audette-Varié in

350mA - **required remote mounted driver see below**

1 x LED array 6,25W (LED incl.) - 350mA - 2700K (633lm) or 3000K (673lm) - CRI >95

FALSE ceiling = aperture : Ø 45 - depth : min. 50 mm - depth for driver in ceiling : min. 70 mm

CONCRETE ceiling = aperture : Ø 45 - depth : min. 40 mm - depth for driver in ceiling : min. 110 mm

CEILING -

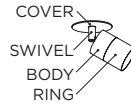

		COLOR LED	COVER black SWIVEL brass BODY black RING black	COVER white SWIVEL brass BODY white RING white	RETAIL PRICE VAT. EXCL.
FALSE ceiling		2700K	ADFCD 2232	ADFCD 2131	315€
FALSE ceiling		3000K	ADFCD 3232	ADFCD 3131	315€
FALSE ceiling	+ honeycomb	2700K	ADFCD 2232H	ADFCD 2131H	325€
FALSE ceiling	+ honeycomb	3000K	ADFCD 3232H	ADFCD 3131H	325€
CONCRETE ceiling		2700K	ADCCD 2232	ADCCD 2131	325€
CONCRETE ceiling		3000K	ADCCD 3232	ADCCD 3131	325€
CONCRETE ceiling	+ honeycomb	2700K	ADCCD 2232H	ADCCD 2131H	335€
CONCRETE ceiling	+ honeycomb	3000K	ADCCD 3232H	ADCCD 3131H	335€

## REQUIRED REMOTE MOUNTED DRIVER

DEVICE	DIM.
1 x	LC (TRIAC/IGBT)
2 x	LC (TRIAC/IGBT)
1-2 x	PU (PUSH-DIM) + DA (DALI)
1-2 x	DA (DALI)
1-2 x	DA (DALI)
2-6 x	PU (PUSH-DIM) + DA (DALI) + I10 (1-10V)

DRIVER	NET PRICE
D 6WT	14€
D 18WT	22€
D 15WP*	25€
D 15WDA EU	28€
D 15WDA US*	28€
D 40WDP*	54€

For warranty use only Trizo21® supplied LED drivers as mentioned.  
For all specs and techs about drivers, see [www.trizo21.com/drivers](http://www.trizo21.com/drivers)

driver remote mounting: driver does not fit through cutout hole of fixture  
\*110V-230V

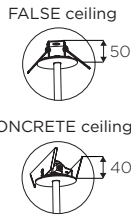
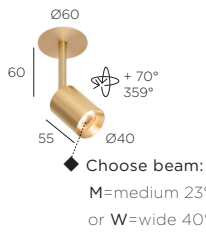

# Audette R6

350mA - **required remote mounted driver see below**

1 x LED array 6.25W (LED incl.) - 350mA - 2700K (633lm) or 3000K (673lm) - CRI >95

FALSE ceiling = aperture : Ø 45 - depth : min. 50 mm - depth for driver in ceiling : min. 70 mm  
 CONCRETE ceiling = aperture : Ø 45 - depth : min. 40 mm - depth for driver in ceiling : min. 110 mm

CEILING -

		COLOR LED	COVER brass ROD + SWIVEL brass BODY brass RING brass	COVER black ROD + SWIVEL black BODY black RING black	COVER white ROD + SWIVEL white BODY white RING white	COVER gunmetal ROD + SWIVEL gunmetal BODY gunmetal RING gunmetal	COVER bronze ROD + SWIVEL bronze BODY bronze RING bronze	COVER nickel ROD + SWIVEL nickel BODY nickel RING nickel	RETAIL PRICE VAT. EXCL.
FALSE ceiling		2700K	ADFC R6 2333						350€
FALSE ceiling		2700K		ADFC R6 2222	ADFC R6 2111				325€
FALSE ceiling		2700K				ADFC R6 2444	ADFC R6 2777	ADFC R6 2999	415€
FALSE ceiling		3000K	ADFC R6 3333						350€
FALSE ceiling		3000K		ADFC R6 3222	ADFC R6 3111				325€
FALSE ceiling		3000K				ADFC R6 3444	ADFC R6 3777	ADFC R6 3999	415€
FALSE ceiling	+ honeycomb	2700K	ADFC R6 2333H						360€
FALSE ceiling	+ honeycomb	2700K		ADFC R6 2222H	ADFC R6 2111H				335€
FALSE ceiling	+ honeycomb	2700K				ADFC R6 2444H	ADFC R6 2777H	ADFC R6 2999H	425€
FALSE ceiling	+ honeycomb	3000K	ADFC R6 3333H						360€
FALSE ceiling	+ honeycomb	3000K		ADFC R6 3222H	ADFC R6 3111H				335€
FALSE ceiling	+ honeycomb	3000K				ADFC R6 3444H	ADFC R6 3777H	ADFC R6 3999H	425€
CONCRETE ceiling		2700K	ADCC R6 2333						360€
CONCRETE ceiling		2700K		ADCC R6 2222	ADCC R6 2111				335€
CONCRETE ceiling		2700K				ADCC R6 2444	ADCC R6 2777	ADCC R6 2999	425€
CONCRETE ceiling		3000K	ADCC R6 3333						360€
CONCRETE ceiling		3000K		ADCC R6 3222	ADCC R6 3111				335€
CONCRETE ceiling		3000K				ADCC R6 3444	ADCC R6 3777	ADCC R6 3999	425€
CONCRETE ceiling	+ honeycomb	2700K	ADCC R6 2333H						370€
CONCRETE ceiling	+ honeycomb	2700K		ADCC R6 2222H	ADCC R6 2111H				345€
CONCRETE ceiling	+ honeycomb	2700K				ADCC R6 2444H	ADCC R6 2777H	ADCC R6 2999H	435€
CONCRETE ceiling	+ honeycomb	3000K	ADCC R6 3333H						370€
CONCRETE ceiling	+ honeycomb	3000K		ADCC R6 3222H	ADCC R6 3111H				345€
CONCRETE ceiling	+ honeycomb	3000K				ADCC R6 3444H	ADCC R6 3777H	ADCC R6 3999H	435€

## REQUIRED REMOTE MOUNTED DRIVER

DEVICE	DIM.	DRIVER	NET PRICE
1 x	LC (TRIAC/IGBT)	D 6WT	14€
2 x	LC (TRIAC/IGBT)	D 18WT	22€
1-2 x	PU (PUSH-DIM) + DA (DALI)	D 15WP*	25€
1-2 x	DA (DALI)	D 15WDA EU	28€
1-2 x	DA (DALI)	D 15WDA US*	28€
2-6 x	PU (PUSH-DIM) + DA (DALI) + I10 (1-10V)	D 40WDP*	54€

For warranty use only Trizo21® supplied LED drivers as mentioned.  
 For all specs and techs about drivers, see [www.trizo21.com/drivers](http://www.trizo21.com/drivers)

driver remote mounting: driver does not fit through cutout hole of fixture  
 \*110V-230V

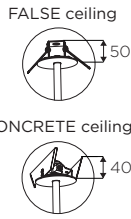
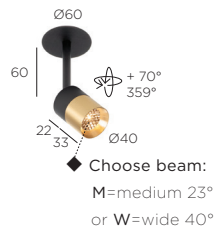

# Audette-Duo R6

350mA - **required remote mounted driver see below**

1 x LED array 6.25W (LED incl.) - 350mA - 2700K (633lm) or 3000K (673lm) - CRI >95

FALSE ceiling = aperture : Ø 45 - depth : min. 50 mm - depth for driver in ceiling : min. 70 mm  
 CONCRETE ceiling = aperture : Ø 45 - depth : min. 40 mm - depth for driver in ceiling : min. 110 mm

CEILING -

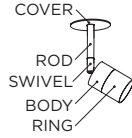

		COLOR LED	COVER brass	ROD + SWIVEL brass	BODY brass	RING black	COVER brass	ROD +SWIVEL brass	BODY brass	RING white	COVER black	ROD +SWIVEL black	BODY black	RING brass	COVER white	ROD +SWIVEL white	BODY white	RING brass	RETAIL PRICE VAT. EXCL.
FALSE ceiling		2700K	●	●	●	●	●	●	●	○	●	●	●	●	○	○	○	○	325€
FALSE ceiling		2700K													●	●	●	●	350€
FALSE ceiling		3000K																	325€
FALSE ceiling		3000K													●	●	●	●	350€
FALSE ceiling	+ honeycomb	2700K	●	●	●	●	●	●	●	○	●	●	●	●	○	○	○	○	335€
FALSE ceiling	+ honeycomb	2700K													●	●	●	●	360€
FALSE ceiling	+ honeycomb	3000K	●	●	●	●	●	●	●	○	●	●	●	●	○	○	○	○	335€
FALSE ceiling	+ honeycomb	3000K													●	●	●	●	360€
CONCRETE ceiling		2700K	●	●	●	●	●	●	●	○	●	●	●	●	○	○	○	○	335€
CONCRETE ceiling		2700K													●	●	●	●	360€
CONCRETE ceiling		3000K	●	●	●	●	●	●	●	○	●	●	●	●	○	○	○	○	335€
CONCRETE ceiling		3000K													●	●	●	●	360€
CONCRETE ceiling	+ honeycomb	2700K	●	●	●	●	●	●	●	○	●	●	●	●	○	○	○	○	345€
CONCRETE ceiling	+ honeycomb	2700K													●	●	●	●	370€
CONCRETE ceiling	+ honeycomb	3000K	●	●	●	●	●	●	●	○	●	●	●	●	○	○	○	○	345€
CONCRETE ceiling	+ honeycomb	3000K													●	●	●	●	370€

## REQUIRED REMOTE MOUNTED DRIVER

DEVICE	DIM.	DRIVER	NET PRICE
1 x	LC (TRIAC/IGBT)	D 6WT	14€
2 x	LC (TRIAC/IGBT)	D 18WT	22€
1-2 x	PU (PUSH-DIM) + DA (DALI)	D 15WP*	25€
1-2 x	DA (DALI)	D 15WDA EU	28€
1-2 x	DA (DALI)	D 15WDA US*	28€
2-6 x	PU (PUSH-DIM) + DA (DALI) + I-10 (1-10V)	D 40WDP*	54€

For warranty use only Trizo21® supplied LED drivers as mentioned.  
 For all specs and techs about drivers, see [www.trizo21.com/drivers](http://www.trizo21.com/drivers)

driver remote mounting: driver does not fit through cutout hole of fixture  
 \*110V-230V





FALSE & CONCRETE ceiling

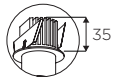

# Audy-In

350mA - **required remote mounted driver see below**

1 x LED array 6.25W (LED incl.) - 350mA - 2700K (633lm) or 3000K (673lm) - CRI >95

FALSE ceiling = aperture : Ø 45 - depth : min. 50 mm - depth for driver in false ceiling : min. 70 mm

CONCRETE ceiling = aperture : Ø 45 - depth : min. 50 mm - depth for driver in concrete ceiling : min. 110 mm

CEILING -

◆ Choose beam:  
M=medium 23°  
or W=wide 40°

COLOR LED	FRAME brass	FRAME black	FRAME white	FRAME gunmetal	FRAME bronze	FRAME nickel	RETAIL PRICE VAT. EXCL.	
2700K	AUDY 1273◆	AUDY 1272◆	AUDY 1271◆				300€	
2700K				AUDY 1274◆	AUDY 1277◆	AUDY 1279◆	345€	
3000K	AUDY 1303◆	AUDY 1302◆	AUDY 1301◆				300€	
3000K				AUDY 1304◆	AUDY 1307◆	AUDY 1309◆	345€	
+ honeycomb	2700K	AUDY 1273H◆	AUDY 1272H◆	AUDY 1271H◆			310€	
+ honeycomb	2700K				AUDY 1274H◆	AUDY 1277H◆	AUDY 1279H◆	355€
+ honeycomb	3000K	AUDY 1303H◆	AUDY 1302H◆	AUDY 1301H◆			310€	
+ honeycomb	3000K				AUDY 1304H◆	AUDY 1307H◆	AUDY 1309H◆	355€

## REQUIRED REMOTE MOUNTED DRIVER

DEVICE	DIM.
1 x	LC (TRIAC/IGBT)
2 x	LC (TRIAC/IGBT)
1-2 x	PU (PUSH-DIM) + DA (DALI)
1-2 x	DA (DALI)
1-2 x	DA (DALI)
2-6 x	PU (PUSH-DIM) + DA (DALI) + I10 (1-10V)

DRIVER	NET PRICE
D 6WT	14€
D 18WT	22€
D 15WP*	25€
D 15WDA EU	28€
D 15WDA US*	28€
D 40WDP*	54€

For warranty use only Trizo21® supplied LED drivers as mentioned.  
For all specs and techs about drivers, see [www.trizo21.com/drivers](http://www.trizo21.com/drivers)

driver remote mounting: driver does not fit through cutout hole of fixture  
\*110V-230V

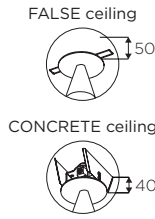

# Aust-In

350mA - **required remote mounted driver see below**

1 x LED array 6W (LED incl.) - 350mA - 634lm - 2700K - CRI >93

FALSE ceiling = aperture : Ø 45 - depth : min. 50 mm - depth for driver in ceiling : min. 70 mm  
 CONCRETE ceiling = aperture : Ø 45 - depth : min. 40 mm - depth for driver in ceiling : min. 110 mm

CEILING -

	FRAME brass	FRAME black	FRAME white	FRAME gunmetal	FRAME bronze	FRAME nickel	RETAIL PRICE VAT. EXCL.
FALSE ceiling	AUIN L003	AUIN L002	AUIN L001				245€
FALSE ceiling				AUIN L004	AUIN L007	AUIN L009	330€
CONCRETE ceiling	ACIN L003	ACIN L002	ACIN L001				255€
CONCRETE ceiling				ACIN L004	ACIN L007	ACIN L009	340€

## REQUIRED REMOTE MOUNTED DRIVER

DEVICE	DIM.
1 x	LC (TRIAC/IGBT)
2 x	LC (TRIAC/IGBT)
1-2 x	PU (PUSH-DIM) + DA (DALI)
1-2 x	DA (DALI)
1-2 x	DA (DALI)
2-6 x	PU (PUSH-DIM) + DA (DALI) + I10 (1-10V)

DRIVER	NET PRICE
D 6WT	14€
D 18WT	22€
D 15WP*	24€
D 15WDA EU	28€
D 15WDA US*	28€
D 40WDP*	54€

For warranty use only Trizo21® supplied LED drivers as mentioned.  
 For all specs and techs about drivers, see [www.trizo21.com/drivers](http://www.trizo21.com/drivers)

driver remote mounting: driver does not fit through cutout hole of fixture  
 \*110V-230V

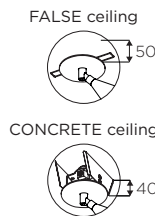
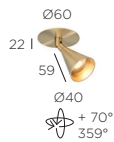

# Aust-In Adjustable

350mA - **required remote mounted driver see below**

1 x LED array 6W (LED incl.) - 350mA - 634lm - 2700K - CRI >93

FALSE ceiling = aperture : Ø 45 - depth : min. 50 mm - depth for driver in ceiling : min. 70 mm  
 CONCRETE ceiling = aperture : Ø 45 - depth : min. 40 mm - depth for driver in ceiling : min. 110 mm

CEILING -

	FRAME brass	FRAME black	FRAME white	FRAME gunmetal	FRAME bronze	FRAME nickel	RETAIL PRICE VAT. EXCL.
FALSE ceiling	AUAN T003	AUAN T002	AUAN T001				305€
FALSE ceiling				AUAN T004	AUAN T007	AUAN T009	385€
CONCRETE ceiling	ACAN T003	ACAN T002	ACAN T001				315€
CONCRETE ceiling				ACAN T004	ACAN T007	ACAN T009	395€

## REQUIRED REMOTE MOUNTED DRIVER

DEVICE	DIM.
1 x	LC (TRIAC/IGBT)
2 x	LC (TRIAC/IGBT)
1-2 x	PU (PUSH-DIM) + DA (DALI)
1-2 x	DA (DALI)
1-2 x	DA (DALI)
2-6 x	PU (PUSH-DIM) + DA (DALI) + I10 (1-10V)

DRIVER	NET PRICE
D 6WT	14€
D 18WT	22€
D 15WP*	24€
D 15WDA EU	28€
D 15WDA US*	28€
D 40WDP*	54€

For warranty use only Trizo21® supplied LED drivers as mentioned.  
 For all specs and techs about drivers, see [www.trizo21.com/drivers](http://www.trizo21.com/drivers)

driver remote mounting: driver does not fit through cutout hole of fixture  
 \*110V-230V

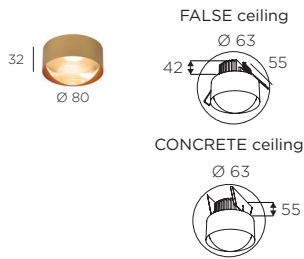

# Bily 16 in

350mA - **required remote mounted driver see below**

1 x LED array 11W (LED incl.) - 350mA - 1125lm - 2700K - CRI >97

FALSE ceiling = aperture : Ø 65 - depth : min. 50 mm - depth for driver in ceiling : min. 70 mm

CONCRETE ceiling = aperture : Ø 65 - depth : min. 70 mm - depth for driver in ceiling : min. 130 mm

CEILING -

		FRAME black	FRAME white	FRAME bronze	FRAME gold	FRAME alu	RETAIL PRICE VAT. EXCL.
FALSE ceiling	silver LED HOLDER	BIINF 1620	BIINF 1610	BIINF 1670	BIINF 1680	BIINF 1690	410€
FALSE ceiling	gold LED HOLDER	BIINF 1628	BIINF 1618	BIINF 1678	BIINF 1688	BIINF 1698	420€
CONCRETE ceiling	silver LED HOLDER	BIINC 1620	BIINC 1610	BIINC 1670	BIINC 1680	BIINC 1690	415€
CONCRETE ceiling	gold LED HOLDER	BIINC 1628	BIINC 1618	BIINC 1678	BIINC 1688	BIINC 1698	425€

## REQUIRED REMOTE MOUNTED DRIVER

DEVICE	DIM.	DRIVER	NET PRICE
1 x	NO (non-dimmable)	N 12W**	23€
1 x	LC (TRIAC/IGBT)	D 18WT	22€
1 x	PU (PUSH-DIM) + 1-10 (1-10V)	D 15WP*	25€
1 x	DA (DALI)	D 15WDA EU	28€
1 x	DA (DALI)	D 15WDA US*	28€
1-3 x	PU (PUSH-DIM) + DA (DALI) + 1-10 (1-10V)	D 40WDP*	57€

For warranty use only Trizo21® supplied LED drivers as mentioned.  
For all specs and techs about drivers, see [www.trizo21.com/drivers](http://www.trizo21.com/drivers)

driver remote mounting: driver does not fit through cutout hole of fixture  
\*110V-230V

37,5



Choose beam:

- N=narrow 10° or
- M=medium 25° or
- W=wide 40°

FALSE ceiling

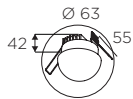

CONCRETE ceiling

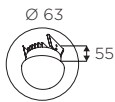

# Bouly 4

350mA - **required remote mounted driver see below**

1 x 4 LED 0.96W (LED incl.) - 350mA - 456lm - 2700K - CRI >93

FALSE ceiling = aperture : Ø 65 - depth : min. 50 mm - depth for driver in ceiling : min. 70 mm

CONCRETE ceiling = aperture : Ø 65 - depth : min. 60 mm - depth for driver in ceiling : min. 130 mm

CEILING -

RETAIL PRICE  
VAT. EXCL.

FALSE ceiling silver LED HOLDER | BOWW 6010 | 360€

CONCRETE ceiling silver LED HOLDER | BOWW 6012 | 370€

## REQUIRED REMOTE MOUNTED DRIVER

DEVICE	DIM.
1 x	NO (non-dimmable)
1 x	C (IGBT)
1 x	PU (PUSH-DIM) + 1-10 (1-10V)
1-2 x	NO (non-dimmable)
1-3 x	PU (PUSH-DIM) + 1-10 (1-10V)
1-3 x	DA (DALI)
1-3 x	DA (DALI)
2-8 x	PU (PUSH-DIM) + DA (DALI) + 1-10 (1-10V)

DRIVER	NET PRICE
N 5W	11€
D 6WI	13€
D 6WP	14€
N 12W**	23€
D 15WP*	25€
D 15WDA EU	28€
D 15WDA US*	28€
D 40WDP*	57€

For warranty use only Trizo21® supplied LED drivers as mentioned.  
For all specs and techs about drivers, see [www.trizo21.com/drivers](http://www.trizo21.com/drivers)

driver remote mounting: driver does not fit through cutout hole of fixture  
\*110V-230V

37,5



FALSE ceiling

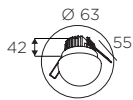

CONCRETE ceiling

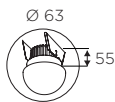

# Bouly 16

350mA - **required remote mounted driver see below**

1 x LED array 11W (LED incl.) - 350mA - 1125lm - 2700K - CRI >97

FALSE ceiling = aperture : Ø 65 - depth : min. 50 mm - depth for driver in ceiling : min. 70 mm

CONCRETE ceiling = aperture : Ø 65 - depth : min. 70 mm - depth for driver in ceiling : min. 130 mm

CEILING -

RETAIL PRICE  
VAT. EXCL.

FALSE ceiling silver LED HOLDER | BOIN 1600 | 370€

FALSE ceiling gold LED HOLDER | BOIN 1608 | 395€

CONCRETE ceiling silver LED HOLDER | BOIN 1602 | 380€

CONCRETE ceiling gold LED HOLDER | BOIN 1680 | 405€

## REQUIRED REMOTE MOUNTED DRIVER

DEVICE	DIM.
1 x	NO (non-dimmable)
1 x	LC (TRIAC/IGBT)
1 x	PU (PUSH-DIM) + 1-10 (1-10V)
1 x	DA (DALI)
1 x	DA (DALI)
1-3 x	PU (PUSH-DIM) + DA (DALI) + 1-10 (1-10V)

DRIVER	NET PRICE
N 12W**	23€
D 18WT	22€
D 15WP*	25€
D 15WDA EU	28€
D 15WDA US*	28€
D 40WDP*	57€

For warranty use only Trizo21® supplied LED drivers as mentioned.  
For all specs and techs about drivers, see [www.trizo21.com/drivers](http://www.trizo21.com/drivers)

driver remote mounting: driver does not fit through cutout hole of fixture  
\*110V-230V



◆ Choose beam:  
 N=narrow 10° or  
 M=medium 25° or  
 W=wide 40°

# Mini-Pi 1 in

350mA - **required remote mounted driver see below**

1 x 4 LED 0.96W (LED incl.) - 350mA - 456lm - 2700K - CRI >93

FALSE ceiling = aperture : Ø 45 - depth : min. 35 mm - depth for driver in ceiling : min. 70 mm

CONCRETE ceiling = aperture : Ø 45 - depth : min. 35 mm - depth for driver in ceiling : min. 110 mm

CEILING -

	FRAME black	FRAME white	FRAME alu	FRAME bronze	RETAIL PRICE VAT. EXCL.
FALSE ceiling	MIPI 1225◆	MIPI 1115◆	MIPI 1995◆	MIPI 1775◆	240€
CONCRETE ceiling	MIPI 1235◆	MIPI 1125◆	MIPI 1925◆	MIPI 1725◆	240€

## REQUIRED REMOTE MOUNTED DRIVER

DEVICE	DIM.
1 x	NO (non-dimmable)
1 x	C (IGBT)
1 x	PU (PUSH-DIM) + 1-10 (1-10V)
2 x	LC (TRIAC/IGBT)
3-4 x	LC (TRIAC/IGBT)
1-3 x	PU (PUSH-DIM) + 1-10 (1-10V)
1-3 x	DA (DALI)
1-3 x	DA (DALI)
2-8 x	PU (PUSH-DIM) + DA (DALI) + 1-10 (1-10V)

DRIVER	NET PRICE
N 5W	11€
D 6WI	13€
D 6WP	14€
D 10WT	18€
D 18WT	22€
D 15WP*	25€
D 15WDA EU	28€
D 15WDA US*	28€
D 40WDP*	57€

For warranty use only Trizo21® supplied LED drivers as mentioned.  
 For all specs and techs about drivers, see [www.trizo21.com/drivers](http://www.trizo21.com/drivers)

driver remote mounting: driver does not fit through cutout hole of fixture  
 \*110V-230V

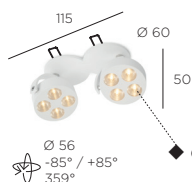

◆ Choose beam:  
 N=narrow 10° or  
 M=medium 25° or  
 W=wide 40°

# Mini-Pi 2 in

350mA - **required remote mounted driver see below**

2 x 4 LED 0.96W (LED incl.) - 350mA - 2 x 456lm - 2700K - CRI >93

FALSE ceiling = aperture : 2 x Ø 45 - depth : min. 35 mm - depth for driver in ceiling : min. 70 mm

CEILING -

	FRAME black	FRAME white	FRAME alu	FRAME bronze	RETAIL PRICE VAT. EXCL.
FALSE ceiling	MIPI 2227◆	MIPI 2117◆	MIPI 2997◆	MIPI 2777◆	480€

## REQUIRED REMOTE MOUNTED DRIVER

DEVICE	DIM.
1 x	LC (TRIAC/IGBT)
1 x	PU (PUSH-DIM) + 1-10 (1-10V)
1 x	DA (DALI)
1 x	DA (DALI)
1-4 x	PU (PUSH-DIM) + DA (DALI) + 1-10 (1-10V)

DRIVER	NET PRICE
D 10WT	18€
D 15WP*	25€
D 15WDA EU	28€
D 15WDA US*	28€
D 40WDP*	57€

For warranty use only Trizo21® supplied LED drivers as mentioned.  
 For all specs and techs about drivers, see [www.trizo21.com/drivers](http://www.trizo21.com/drivers)

driver remote mounting: driver does not fit through cutout hole of fixture  
 \*110V-230V

FALSE ceiling



CONCRETE ceiling



# Pin-In 1

12V - transformer excluded

G53 - 1 x R111 max. 100W or R111 LED

FALSE ceiling = aperture : Ø 60 - depth : min. 55

CONCRETE ceiling = aperture : Ø 60 - depth : min. 20

Bulb excluded - CEILING -

	FRAME black	FRAME white	FRAME alu	FRAME bronze	FRAME chrome	RETAIL PRICE VAT. EXCL.
FALSE ceiling	PIIN 2101	PIIN 1101	PIIN 4101			135€
FALSE ceiling				PIIN 7101	PIIN 9101	200€
CONCRETE ceiling	PIIN 2111	PIIN 1111	PIIN 4111			145€
CONCRETE ceiling				PIIN 7111	PIIN 9111	210€



# Pin-In 2

12V - transformer excluded

G53 - 2 x R111 max. 100W or R111 LED

FALSE ceiling = aperture : 2 x Ø 60 - depth : min. 55

Bulbs excluded - CEILING -

	FRAME black	FRAME white	FRAME alu	FRAME bronze	FRAME chrome	RETAIL PRICE VAT. EXCL.
	PIIN 2102	PIIN 1102	PIIN 4102			260€
				PIIN 7102	PIIN 9102	355€

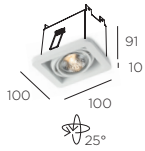

# R51 in GU10

230V

GU10 - 1 x HALO QPAR16 (alu reflector / no cool beam) max. 50W or 1 x GU10 LED

aperture : L 84 W 92 H 97 - depth : min. 120

Bulb excluded - CEILING -

	FRAME black INTERIOR black	FRAME black INTERIOR white	FRAME white INTERIOR black	FRAME white INTERIOR white	FRAME chrome INTERIOR black	FRAME chrome INTERIOR white	RETAIL PRICE VAT. EXCL.
black RING	● ●	● ○	○ ●	○ ○	● ●	● ○	
chrome RING	● ●	● ○	○ ●	○ ○	● ●	● ○	
white RING	○ ○	○ ○	○ ○	○ ○	○ ○	○ ○	
	MIGU 1222	MIGU 1122	MIGU 1212	MIGU 1112			175€
	MIGU 1229	MIGU 1129	MIGU 1219	MIGU 1119			240€
	MIGU 1221	MIGU 1121	MIGU 1211	MIGU 1111			175€
black RING	● ●				MIGU 1292	MIGU 1192	225€
chrome RING	● ●				MIGU 1299	MIGU 1199	295€
white RING	○ ○				MIGU 1291	MIGU 1191	225€

## ACCESSORY FOR CONCRETE CEILING: CONCRETE BOX



concrete box: L 87 W 97 H 112  
aperture: L 90 W 100 H 120

COGU 0051 | 55€

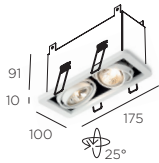

# R52 in GU10

230V

GU10 - 2 x HALO QPAR16 (alu reflector / no cool beam) max. 50W or 2 x GU10 LED

aperture : L 159 W 92 H 97 - depth : min. 120

Bulbs excluded - CEILING -

	FRAME black INTERIOR black	FRAME black INTERIOR white	FRAME white INTERIOR black	FRAME white INTERIOR white	FRAME chrome INTERIOR black	FRAME chrome INTERIOR white	RETAIL PRICE VAT. EXCL.
black RING	● ●	● ○	○ ●	○ ○	● ●	● ○	
chrome RING	● ●	● ○	○ ●	○ ○	● ●	● ○	
white RING	○ ○	○ ○	○ ○	○ ○	○ ○	○ ○	
	MIGU 2222	MIGU 2122	MIGU 2212	MIGU 2112			245€
	MIGU 2229	MIGU 2129	MIGU 2219	MIGU 2119			365€
	MIGU 2221	MIGU 2121	MIGU 2211	MIGU 2111			245€
black RING	● ●				MIGU 2292	MIGU 2192	315€
chrome RING	● ●				MIGU 2299	MIGU 2199	435€
white RING	○ ○				MIGU 2291	MIGU 2191	315€

## ACCESSORY FOR CONCRETE CEILING: CONCRETE BOX

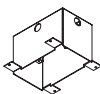

concrete box: L 162 W 97 H 112  
aperture: L 165 W 100 H 120

COGU 0052 | 60€

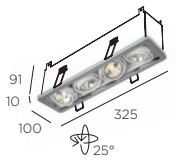

# R54 in GU10

230V  
 GU10 - 4 x HALO QPAR16 (alu reflector / no cool beam) max. 50W or 4 x GU10 LED  
 aperture : L 309 W 92 H 97 - depth : min. 120  
**Bulbs excluded - CEILING -**

	FRAME black INTERIOR black	FRAME black INTERIOR white	FRAME white INTERIOR black	FRAME white INTERIOR white	FRAME chrome INTERIOR black	FRAME chrome INTERIOR white	RETAIL PRICE VAT. EXCL.
black RING	● ●	● ○	○ ●	○ ○	● ●	○ ○	
chrome RING	● ●	● ○	○ ●	○ ○	● ●	○ ○	
white RING	○ ○	○ ○	○ ○	○ ○	○ ○	○ ○	
black RING							
chrome RING							
white RING							
	MIGU 4222	MIGU 4122	MIGU 4212	MIGU 4112			365€
	MIGU 4229	MIGU 4129	MIGU 4219	MIGU 4119			635€
	MIGU 4221	MIGU 4121	MIGU 4211	MIGU 4111			365€
					MIGU 4292	MIGU 4192	450€
					MIGU 4299	MIGU 4199	705€
					MIGU 4291	MIGU 4191	450€

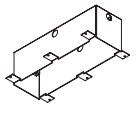

concrete box: L 312 W 97 H 112  
 aperture: L 315 W 100 H 120

## ACCESSORY FOR CONCRETE CEILING: CONCRETE BOX

COGU 0054 | 80€



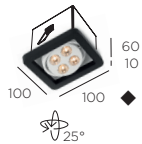

◆ Choose beam:  
 N=narrow 10° or  
 M=medium 25° or  
 W=wide 40°

# R51 in LED

350mA - **required remote mounted driver see below**  
 1 x 4 LED 0.96W (LED incl.) - 350mA - 456lm - 2700K - CRI >93  
 aperture : L 84 W 92 H 66 - depth : min. 90  
**CEILING** -

	FRAME black INTERIOR black	FRAME black INTERIOR white	FRAME white INTERIOR black	FRAME white INTERIOR white	FRAME chrome INTERIOR black	FRAME chrome INTERIOR white	RETAIL PRICE VAT. EXCL.
black RING	●	●	●	○	●	●	
white RING	○	○	○	○	○	○	
black RING	●						
white RING	○						
	MIWW 1222 ◆	MIWW 1122 ◆	MIWW 1212 ◆	MIWW 1112 ◆			315€
	MIWW 1221 ◆	MIWW 1121 ◆	MIWW 1211 ◆	MIWW 1111 ◆			315€
					MIWW 1292 ◆	MIWW 1192 ◆	360€
					MIWW 1291 ◆	MIWW 1191 ◆	360€

## REQUIRED REMOTE MOUNTED DRIVER

DEVICE	DIM.
1 x	NO (non-dimmable)
1 x	C (IGBT)
1 x	PU (PUSH-DIM) + 1-10 (1-10V)
1-3 x	PU (PUSH-DIM) + 1-10 (1-10V)
1-3 x	DA (DALI)
1-3 x	DA (DALI)
2-8 x	PU (PUSH-DIM) + DA (DALI) + 1-10 (1-10V)

DRIVER	NET PRICE
N 5W	11€
D 6WI	13€
D 6WP	14€
D 15WP*	25€
D 15WDA EU	28€
D 15WDA US*	28€
D 40WDP*	57€

For warranty use only Trizo21® supplied LED drivers as mentioned.  
 For all specs and techs about drivers, see [www.trizo21.com/drivers](http://www.trizo21.com/drivers)

driver remote mounting: driver does not fit through cutout hole of fixture  
 \*110V-230V



concrete box: L 87 W 97 H 106  
 aperture: L 90 W 100 H 108

## ACCESSORY FOR CONCRETE CEILING: CONCRETE BOX

CONC 0051 | 55€



◆ Choose beam:  
 N=narrow 10° or  
 M=medium 25° or  
 W=wide 40°

# R51 Rimless LED

350mA - **required remote mounted driver see below - installation kit required**  
 1 x 4 LED 0.96W (LED incl.) - 350mA - 456lm - 2700K - CRI >93  
**CEILING** -

	INTERIOR black	INTERIOR white	RETAIL PRICE VAT. EXCL.
black RING	●	○	
white RING	○	○	
	MRWW 1202 ◆	MRWW 1102 ◆	275€
	MRWW 1201 ◆	MRWW 1101 ◆	275€

## REQUIRED REMOTE MOUNTED DRIVER

DEVICE	DIM.
1 x	NO (non-dimmable)
1 x	C (IGBT)
1 x	PU (PUSH-DIM) + 1-10 (1-10V)
1-3 x	PU (PUSH-DIM) + 1-10 (1-10V)
1-3 x	DA (DALI)
1-3 x	DA (DALI)
2-8 x	PU (PUSH-DIM) + DA (DALI) + 1-10 (1-10V)

DRIVER	NET PRICE
N 5W	11€
D 6WI	13€
D 6WP	14€
D 15WP*	25€
D 15WDA EU	28€
D 15WDA US*	28€
D 40WDP*	57€

For warranty use only Trizo21® supplied LED drivers as mentioned.  
 For all specs and techs about drivers, see [www.trizo21.com/drivers](http://www.trizo21.com/drivers)

driver remote mounting: driver does not fit through cutout hole of fixture  
 \*110V-230V

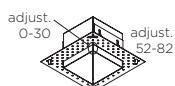

installation kit: L 145 W 145 H 82  
 aperture: L 100 W 90 H 84

## REQUIRED INSTALLATION KIT FOR RIMLESS

PLAS 0051 | 90€

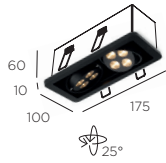

◆ Choose beam:  
 N=narrow 10° or  
 M=medium 25° or  
 W=wide 40°

# R52 in LED

350mA - **required remote mounted driver see below**

2 x 4 LED 0.96W (LED incl.) - 350mA - 2 x 456lm - 2700K - CRI >93

aperture : L 159 W 92 H 66 - depth : min. 90

CEILING -

	FRAME black INTERIOR black	FRAME black INTERIOR white	FRAME white INTERIOR black	FRAME white INTERIOR white	FRAME chrome INTERIOR black	FRAME chrome INTERIOR white	RETAIL PRICE VAT. EXCL.
	● ●	● ○	○ ●	○ ○	● ●	● ○	
black RING	●	MIWW 2222 ◆	MIWW 2122 ◆	MIWW 2212 ◆	MIWW 2112 ◆		570€
white RING	○	MIWW 2221 ◆	MIWW 2121 ◆	MIWW 2211 ◆	MIWW 2111 ◆		570€
black RING	●				MIWW 2292 ◆	MIWW 2192 ◆	635€
white RING	○				MIWW 2291 ◆	MIWW 2191 ◆	635€

## REQUIRED REMOTE MOUNTED DRIVER

DEVICE	DIM.	DRIVER	NET PRICE
1 x	LC (TRIAC/IGBT)	D 10WT	18€
1 x	PU (PUSH-DIM) + 1-10 (1-10V)	D 15WP*	25€
1 x	DA (DALI)	D 15WDA EU	28€
1 x	DA (DALI)	D 15WDA US*	28€
1-4 x	PU (PUSH-DIM) + DA (DALI) + 1-10 (1-10V)	D 40WDP*	57€

For warranty use only Trizo21® supplied LED drivers as mentioned.  
 For all specs and techs about drivers, see [www.trizo21.com/drivers](http://www.trizo21.com/drivers)

## ACCESSORY FOR CONCRETE CEILING: CONCRETE BOX

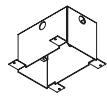

concrete box: L 162 W 97 H 106  
 aperture: L 165 W 100 H 108

CONC 0052 | 60€



◆ Choose beam:  
 N=narrow 10° or  
 M=medium 25° or  
 W=wide 40°

# R52 Rimless LED

350mA - **required remote mounted driver see below - installation kit required**

2 x 4 LED 0.96W (LED incl.) - 350mA - 2 x 456lm - 2700K - CRI >93

CEILING -

	INTERIOR black	INTERIOR white	RETAIL PRICE VAT. EXCL.	
	●	○		
black RING	●	MRWW 2202 ◆	MRWW 2102 ◆	515€
white RING	○	MRWW 2201 ◆	MRWW 2101 ◆	515€

## REQUIRED REMOTE MOUNTED DRIVER

DEVICE	DIM.	DRIVER	NET PRICE
1 x	LC (TRIAC/IGBT)	D 10WT	18€
1 x	PU (PUSH-DIM) + 1-10 (1-10V)	D 15WP*	25€
1 x	DA (DALI)	D 15WDA EU	28€
1 x	DA (DALI)	D 15WDA US*	28€
1-4 x	PU (PUSH-DIM) + DA (DALI) + 1-10 (1-10V)	D 40WDP*	57€

For warranty use only Trizo21® supplied LED drivers as mentioned.  
 For all specs and techs about drivers, see [www.trizo21.com/drivers](http://www.trizo21.com/drivers)

## REQUIRED INSTALLATION KIT FOR RIMLESS

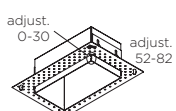

installation kit: L 220 W 145 H 82  
 aperture: L 175 W 90 H 84

PLAS 0052 | 95€

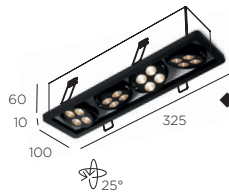

◆ Choose beam:  
 N=narrow 10° or  
 M=medium 25° or  
 W=wide 40°

# R54 in LED

350mA - **required remote mounted driver see below**

4 x 4 LED 0.96W (LED incl.) - 350mA - 4 x 456lm - 2700K - CRI >93

aperture : L 309 W 92 H 66 - depth : min. 90

CEILING -

	FRAME black INTERIOR black	FRAME black INTERIOR white	FRAME white INTERIOR black	FRAME white INTERIOR white	FRAME chrome INTERIOR black	FRAME chrome INTERIOR white	RETAIL PRICE VAT. EXCL.
	● ●	● ○	○ ●	○ ○	● ●	● ○	
black RING ●	MIWW 4222◆	MIWW 4122◆	MIWW 4212◆	MIWW 4112◆			1.040€
white RING ○	MIWW 4221◆	MIWW 4121◆	MIWW 4211◆	MIWW 4111◆			1.040€
black RING ●					MIWW 4292◆	MIWW 4192◆	1.115€
white RING ○					MIWW 4291◆	MIWW 4191◆	1.115€

## REQUIRED REMOTE MOUNTED DRIVER

DEVICE	DIM.	DRIVER	NET PRICE
1-2 x	PU (PUSH-DIM) + DA (DALI) + I10 (1-10V)	D 40WDP* *110V-230V	57€

For warranty use only Trizo21® supplied LED drivers as mentioned.  
 For all specs and techs about drivers, see [www.trizo21.com/drivers](http://www.trizo21.com/drivers)

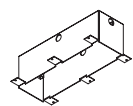

concrete box: L 312 W 97 H 106  
 aperture: L 315 W 100 H 108

## ACCESSORY FOR CONCRETE CEILING: CONCRETE BOX

CONC 0054 | 80€

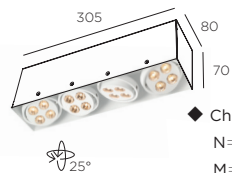

◆ Choose beam:  
 N=narrow 10° or  
 M=medium 25° or  
 W=wide 40°

# R54 Rimless LED

350mA - **required remote mounted driver see below - installation kit required**

4 x 4 LED 0.96W (LED incl.) - 350mA - 4 x 456lm - 2700K - CRI >93

CEILING -

	INTERIOR black	INTERIOR white	RETAIL PRICE VAT. EXCL.
	●	○	
black RING ●	MRWW 4202◆	MRWW 4102◆	950€
white RING ○	MRWW 4201◆	MRWW 4101◆	950€

## REQUIRED REMOTE MOUNTED DRIVER

DEVICE	DIM.	DRIVER	NET PRICE
1-2 x	PU (PUSH-DIM) + DA (DALI) + I10 (1-10V)	D 40WDP* *110V-230V	57€

For warranty use only Trizo21® supplied LED drivers as mentioned.  
 For all specs and techs about drivers, see [www.trizo21.com/drivers](http://www.trizo21.com/drivers)

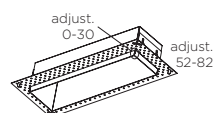

installation kit: L 370 W 145 H 82  
 aperture: L 325 W 90 H 84

## REQUIRED INSTALLATION KIT FOR RIMLESS

PLAS 0054 | 110€



# R07 in

12V - **transformer excluded**  
 BA15d - 1 x QR70 max. 50W. LED version available on demand.  
 aperture : L 104 W 106 H 105  
**Bulb excluded - CEILING** -

	FRAME black INTERIOR black	FRAME black INTERIOR white	FRAME white INTERIOR black	FRAME white INTERIOR white	FRAME chrome INTERIOR black	FRAME chrome INTERIOR white	RETAIL PRICE VAT. EXCL.
black RING	● ●	● ○	○ ●	○ ○	● ●	○ ○	235€
chrome RING	● ●	● ○	○ ●	○ ○	● ●	○ ○	290€
white RING	○ ○	○ ○	○ ○	○ ○	○ ○	○ ○	235€
black RING					● ●	○ ○	270€
chrome RING					● ●	○ ○	355€
white RING					○ ○	○ ○	270€
	ARIN 2222	ARIN 2122	ARIN 2212	ARIN 2112	ARIN 2292	ARIN 2192	
	ARIN 2229	ARIN 2129	ARIN 2219	ARIN 2119	ARIN 2299	ARIN 2199	
	ARIN 2221	ARIN 2121	ARIN 2211	ARIN 2111	ARIN 2291	ARIN 2191	



concrete box: L 105 W 112 H 106  
 aperture: L 108 W 115 H 108

## ACCESSORY FOR CONCRETE CEILING: CONCRETE BOX

CONC 0007 | 65€

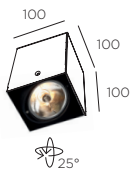

# R07 Rimless

12V - **transformer excluded - installation kit required**  
 BA15d - 1 x QR70 max. 50W. LED version available on demand.  
**Bulb excluded - CEILING** -

	INTERIOR black	INTERIOR white	RETAIL PRICE VAT. EXCL.
black RING	●	○	170€
chrome RING	●	○	220€
white RING	○	○	170€
	ARRI 2222	ARRI 2122	
	ARRI 2229	ARRI 2129	
	ARRI 2221	ARRI 2121	

## REQUIRED INSTALLATION KIT FOR RIMLESS

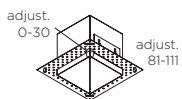

installation kit: L 165 W 165 H 111  
 aperture: L 120 W 110 H 113

PLAS 0007 | 95€

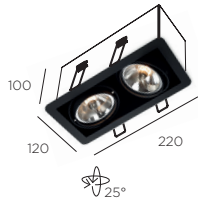

# R70 in

12V - **transformer excluded**  
 BA15d - 2 x QR70 max. 50W. LED version available on demand.  
 aperture : L 204 W 106 H 105  
**Bulbs excluded - CEILING -**

	FRAME black INTERIOR black	FRAME black INTERIOR white	FRAME white INTERIOR black	FRAME white INTERIOR white	FRAME chrome INTERIOR black	FRAME chrome INTERIOR white	RETAIL PRICE VAT. EXCL.
black RING	● ●	● ○	○ ●	○ ○	● ●	● ○	330€
chrome RING	● ●	● ○	○ ●	○ ○	● ●	● ○	515€
white RING	○ ○	○ ○	○ ○	○ ○	○ ○	○ ○	330€
black RING					● ●	● ○	400€
chrome RING					● ●	● ○	585€
white RING					○ ○	○ ○	400€

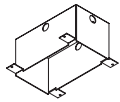

concrete box: L 205 W 112 H 106  
 aperture: L 208 W 115 H 108

## ACCESSORY FOR CONCRETE CEILING: CONCRETE BOX

CONC 0070 | 85€



# R70 Rimless

12V - **transformer excluded - installation kit required**  
 BA15d - 2 x QR70 max. 50W. LED version available on demand.  
**Bulbs excluded - CEILING -**

	INTERIOR black	INTERIOR white	RETAIL PRICE VAT. EXCL.
black RING	●	○	250€
chrome RING	●	○	435€
white RING	○	○	250€

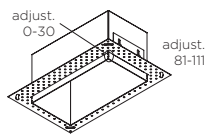

installation kit: L 265 W 165 H 111  
 aperture: L 220 W 110 H 113

## REQUIRED INSTALLATION KIT FOR RIMLESS

PLAS 0070 | 110€



# R110 in G53

12V - transformer excluded

G53 - 1 x R111 max. 100W or R111 LED

aperture : L 149 W 151 H 80 - depth : min. 120

Bulb excluded - CEILING -

	FRAME black INTERIOR black	FRAME black INTERIOR white	FRAME white INTERIOR black	FRAME white INTERIOR white	FRAME chrome INTERIOR black	FRAME chrome INTERIOR white	RETAIL PRICE VAT. EXCL.
black RING ●	ARIN 0222	ARIN 0122	ARIN 0212	ARIN 0112			245€
chrome RING ●	ARIN 0229	ARIN 0129	ARIN 0219	ARIN 0119			335€
white RING ○	ARIN 0221	ARIN 0121	ARIN 0211	ARIN 0111			245€
black RING ●					ARIN 0292	ARIN 0192	315€
chrome RING ●					ARIN 0299	ARIN 0199	405€
white RING ○					ARIN 0291	ARIN 0191	315€



concrete box: L 152 W 158 H 120  
aperture: L 155 W 161 H 122

## ACCESSORY FOR CONCRETE CEILING: CONCRETE BOX

CONC 0110 | 80€



# R110 Rimless

12V - transformer excluded - installation kit required

G53 - 1 x R111 max. 100W or R111 LED

Bulb excluded - CEILING -

	INTERIOR black	INTERIOR white	RETAIL PRICE VAT. EXCL.
black RING ●	ARRI 0222	ARRI 0122	175€
chrome RING ●	ARRI 0229	ARRI 0129	255€
white RING ○	ARRI 0221	ARRI 0121	175€

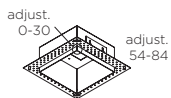

installation kit: L 210 W 210 H 84  
aperture: L 165 W 155 H 8

## REQUIRED INSTALLATION KIT FOR RIMLESS

PLAS 0110 | 105€



# R111 in G53

12V - transformer excluded

G53 - 2 x R111 max. 100W or R111 LED

aperture : L 289 W 151 H 80 - depth : min. 120

Bulbs excluded - CEILING -

	FRAME black INTERIOR black	FRAME black INTERIOR white	FRAME white INTERIOR black	FRAME white INTERIOR white	FRAME chrome INTERIOR black	FRAME chrome INTERIOR white	RETAIL PRICE VAT. EXCL.
black RING ●	ARIN 1222	ARIN 1122	ARIN 1212	ARIN 1112			355€
chrome RING ●	ARIN 1229	ARIN 1129	ARIN 1219	ARIN 1119			545€
white RING ○	ARIN 1221	ARIN 1121	ARIN 1211	ARIN 1111			355€
black RING ●					ARIN 1292	ARIN 1192	430€
chrome RING ●					ARIN 1299	ARIN 1199	620€
white RING ○					ARIN 1291	ARIN 1191	430€

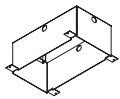

concrete box: L 292 W 158 H 120  
aperture: L 295 W 161 H 122

ACCESSORY FOR CONCRETE CEILING: CONCRETE BOX

CONC 0111 | 95€



# R111 Rimless

12V - transformer excluded - installation kit required

G53 - 2 x R111 max. 100W or R111 LED

Bulbs excluded - CEILING -

	INTERIOR black ●	INTERIOR white ○	RETAIL PRICE VAT. EXCL.
black RING ●	ARRI 1222	ARRI 1122	270€
chrome RING ●	ARRI 1229	ARRI 1129	460€
white RING ○	ARRI 1221	ARRI 1121	270€

**REQUIRED INSTALLATION KIT FOR RIMLESS**

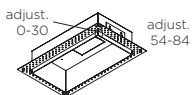

installation kit: L 350 W 210 H 84  
aperture: L 305 W 155 H 86

PLAS 0111 | 120€

# Bathroom



**BILY BATHROOM**

Bily 16 BATHROOM

139

---



**AUDY BATHROOM**

Audy-In BATHROOM

138

---



**7TY BATHROOM**

7Ty up BATHROOM

138

---



**BILY UP BATHROOM**

Bily 16 up BATHROOM

139

---



# Bathroom



## CODE 1 BATHROOM

Code 1 GU10 BATHROOM	141
Code 1 LED BATHROOM	141

---



## BOULY BATHROOM

Bouly 4 BATHROOM	140
Bouly 16 BATHROOM	140

---



## CODE W BATHROOM

Code W G9 BATHROOM	142
Code W LED BATHROOM	143

---



## CODE 2 BATHROOM

Code 2 GU10 BATHROOM	141
Code 2 LED BATHROOM	142

---

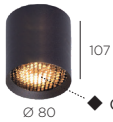

Choose beam:  
 N=narrow 12° or  
 M=medium 24° or  
 W=wide 40°

# Ty up BATHROOM

230V - driver included in base - **LC** (TRIAC/IGBT) dimmable  
 1 x LED array 11,8W (LED incl.) - 250mA - 913lm - 2700K - CRI >97  
**CEILING** -

	DIM	FRAME black	FRAME white	FRAME bronze	FRAME gold	FRAME alu	RETAIL PRICE VAT. EXCL.
	<b>LC</b>	STEP 1002◆	STEP 1001◆	STEP 1007◆	STEP 1008◆	STEP 1009◆	325€
<b>+ honeycomb</b>	<b>LC</b>	STEP 1002H◆	STEP 1001H◆	STEP 1007H◆	STEP 1008H◆	STEP 1009H◆	335€



FALSE & CONCRETE ceiling

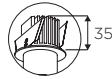

# Audy-In BATHROOM

350mA - **required remote mounted driver see below**

1 x LED array 6,25W (incl.) - 350mA - 2700K (633lm) or 3000K (673lm) - 3000K - CRI >95

**FALSE ceiling** = aperture : Ø 45 - depth : min. 50 mm - depth for driver in false ceiling : min. 70 mm

**CONCRETE ceiling** = aperture : Ø 45 - depth : min. 50 mm - depth for driver in concrete ceiling : min. 110 mm

**CEILING** -

COLOR LED	FRAME brass	FRAME black	FRAME white	FRAME gunmetal	FRAME bronze	FRAME nickel	RETAIL PRICE VAT. EXCL.
2700K	AUDEX 1273◆	AUDEX 1272◆	AUDEX 1271◆				330€
2700K				AUDEX 1274◆	AUDEX 1277◆	AUDEX 1279◆	375€
3000K	AUDEX 1303◆	AUDEX 1302◆	AUDEX 1301◆				330€
3000K				AUDEX 1304◆	AUDEX 1307◆	AUDEX 1309◆	375€

## REQUIRED REMOTE MOUNTED DRIVER

DEVICE	DIM.	DRIVER	NET PRICE
1 x	<b>LC</b> (TRIAC/IGBT)	D 6WT	14€
2 x	<b>LC</b> (TRIAC/IGBT)	D 18WT	22€
1-2 x	<b>PU</b> (PUSH-DIM) + <b>DA</b> (DALI)	D 15WP*	25€
1-2 x	<b>DA</b> (DALI)	D 15WDA EU	28€
1-2 x	<b>DA</b> (DALI)	D 15WDA US*	28€
2-6 x	<b>PU</b> (PUSH-DIM) + <b>DA</b> (DALI) + <b>I10</b> (1-10V)	D 40WDP*	54€

For warranty use only Trizo21® supplied LED drivers as mentioned.  
 For all specs and techs about drivers, see [www.trizo21.com/drivers](http://www.trizo21.com/drivers)

driver remote mounting: driver does not fit through cutout hole of fixture  
 \*110V-230V





Choose beam:  
 N=narrow 10° or  
 M=medium 25° or  
 W=wide 40°

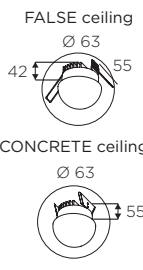

# Bouly 4 BATHROOM

350mA - **required remote mounted driver see below**

1 x 4 LED 0.96W (LED incl.) - 350mA - 456lm - 2700K - CRI >93

FALSE ceiling = aperture : Ø 65 - depth : min. 50 mm - depth for driver in ceiling : min. 70 mm

CONCRETE ceiling = aperture : Ø 65 - depth : min. 60 mm - depth for driver in ceiling : min. 130 mm

CEILING - CE IP55 eco

RETAIL PRICE  
 VAT. EXCL.

FALSE ceiling silver LED HOLDER | BEWW 6010 | 415€

CONCRETE ceiling silver LED HOLDER | BEWW 6012 | 425€

## REQUIRED REMOTE MOUNTED DRIVER

DEVICE	DIM.	DRIVER	NET PRICE
1 x	NO (non-dimmable)	N 5W	11€
1 x	C (IGBT)	D 6WI	13€
1 x	PU (PUSH-DIM) + 1-10 (1-10V)	D 6WP	14€
1-2 x	NO (non-dimmable)	N 12W**	23€
1-3 x	PU (PUSH-DIM) + 1-10 (1-10V)	D 15WP*	25€
1-3 x	DA (DALI)	D 15WDA EU	28€
1-3 x	DA (DALI)	D 15WDA US*	28€
2-8 x	PU (PUSH-DIM) + DA (DALI) + 1-10 (1-10V)	D 40WDP*	57€

For warranty use only Trizo21<sup>®</sup> supplied LED drivers as mentioned.  
 For all specs and techs about drivers, see [www.trizo21.com/drivers](http://www.trizo21.com/drivers)

driver remote mounting: driver does not fit through cutout hole of fixture  
 \*110V-230V

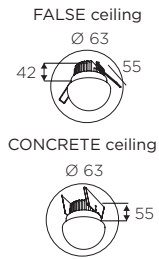

# Bouly 16 BATHROOM

350mA - **required remote mounted driver see below**

1 x LED array 11W (LED incl.) - 350mA - 1125lm - 2700K - CRI >97

FALSE ceiling = aperture : Ø 65 - depth : min. 50 mm - depth for driver in ceiling : min. 70 mm

CONCRETE ceiling = aperture : Ø 65 - depth : min. 70 mm - depth for driver in ceiling : min. 130 mm

CEILING - CE IP55 eco

RETAIL PRICE  
 VAT. EXCL.

FALSE ceiling silver LED HOLDER | BOEX 1600 | 425€  
 FALSE ceiling gold LED HOLDER | BOEX 1608 | 440€

CONCRETE ceiling silver LED HOLDER | BOEX 1602 | 435€  
 CONCRETE ceiling gold LED HOLDER | BOEX 1680 | 455€

## REQUIRED REMOTE MOUNTED DRIVER

DEVICE	DIM.	DRIVER	NET PRICE
1 x	NO (non-dimmable)	N 12W**	23€
1 x	LC (TRIAC/IGBT)	D 18WT	22€
1 x	PU (PUSH-DIM) + 1-10 (1-10V)	D 15WP*	25€
1 x	DA (DALI)	D 15WDA EU	28€
1 x	DA (DALI)	D 15WDA US*	28€
1-3 x	PU (PUSH-DIM) + DA (DALI) + 1-10 (1-10V)	D 40WDP*	57€

For warranty use only Trizo21<sup>®</sup> supplied LED drivers as mentioned.  
 For all specs and techs about drivers, see [www.trizo21.com/drivers](http://www.trizo21.com/drivers)

driver remote mounting: driver does not fit through cutout hole of fixture  
 \*110V-230V



# Code 1 GU10 BATHROOM

230V - GU10 - 1 x HALO QPAR16 max. 35W or 1 x GU10 LED  
**Bulb excluded - CEILING -**

FRAME black	FRAME white	FRAME alu	RETAIL PRICE VAT. EXCL.
<input checked="" type="radio"/>	<input type="radio"/>	<input type="radio"/>	

COEX 3001      COEX 1001      COEX 2001      |      240€

OPTIONAL COVER CODE 1 BATHROOM & CODE 1 LED BATHROOM

ACEX 7055      ACEX 2055      ACEX 1055      |      50€

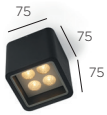

# Code 1 LED BATHROOM

- ◆ Choose beam:
- N=narrow 10° or
- M=medium 25° or
- W=wide 40°

230V - **driver included in base - non-dimmable**  
 1 x 4 LED 0.96W (LED incl.) - 350mA - 456lm - 2700K - CRI >93  
**CEILING -**

FRAME black	FRAME white	FRAME alu	RETAIL PRICE VAT. EXCL.
<input checked="" type="radio"/>	<input type="radio"/>	<input type="radio"/>	

COEX 2151◆      COEX 1151◆      COEX 7151◆      |      405€

OPTIONAL COVER CODE 1 BATHROOM & CODE 1 LED BATHROOM

ACEX 7055      ACEX 2055      ACEX 1055      |      50€



# Code 2 GU10 BATHROOM

230V - GU10 - 2 x HALO QPAR16 max. 35W or 2 x GU10 LED  
**Bulbs excluded - CEILING -**

FRAME black	FRAME white	FRAME alu	RETAIL PRICE VAT. EXCL.
<input checked="" type="radio"/>	<input type="radio"/>	<input type="radio"/>	

COEX 3002      COEX 1002      COEX 2002      |      290€

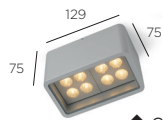

◆ Choose beam:  
**N**=narrow 10° or  
**M**=medium 25° or  
**W**=wide 40°

# Code 2 LED BATHROOM

230V - driver included in base - non-dimmable  
 1 x 8 LED 0.96W (LED incl.) - 350mA - 912lm - 2700K - CRI >93  
**CEILING** -

FRAME black ●	FRAME white ○	FRAME alu ●	RETAIL PRICE VAT. EXCL.
COEX 2251◆	COEX 1251◆	COEX 7251◆	635€

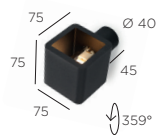

# Code W G9 BATHROOM

230V - G9 - 1 x HALO QT14 max. 60W or 1 x G9 LED (max. Ø19, max. L 62mm)  
**Bulb excluded - WALL** -

FRAME black ●	FRAME white ○	FRAME alu ●	RETAIL PRICE VAT. EXCL.
230V - G9 HALO   CODE 2006	CODE 1006	CODE 7006	225€
230V - G9 LED   CODE L2006	CODE L1006	CODE L7006	225€

OPTIONAL COVER FOR CODE W BATHROOM

ACEX 2006	ACEX 1006	ACEX 7006	50€
-----------	-----------	-----------	-----



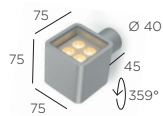

◆ Choose beam:  
 N=narrow 10° or  
 M=medium 25° or  
 W=wide 40°

# Code W LED BATHROOM

350mA - **required remote mounted driver see below**

1 lighting side : 1 x 4 LED 0.96W (LED incl.) - 350mA - 456lm - 2700K - CRI >93  
 2 lighting sides : 2 x 4 LED 0.96W (LED incl.) - 350mA - 2 x 456lm - 2700K - CRI >93  
**WALL** - CE

FRAME black



FRAME white



FRAME alu



RETAIL PRICE  
 VAT. EXCL.

1 side	COEX 2111◆	COEX 1111◆	COEX 7111◆		475€
2 sides	COEX 2211◆	COEX 1211◆	COEX 7211◆		665€



OPTIONAL COVER FOR CODE W LED BATHROOM

ACEX 2006	ACEX 1006	ACEX 7006		50€
-----------	-----------	-----------	--	-----

## REQUIRED REMOTE MOUNTED DRIVER

DEVICE	DIM.	DRIVER	NET PRICE
1 x 1 side	NO (non-dimmable)	N 5W ***	11€
1 x 1 side	C (IGBT)	D 6WI ***	13€
1 x 1 side	PU (PUSH-DIM) + I-10 (1-10V)	D 6WP ***	14€
1-2 x 1 side	NO (non-dimmable)	N 12W**	23€
2 x 1 side	LC (TRIAC/IGBT)	D 10WT ***	18€
1-3 x 1 side	PU (PUSH-DIM) + I-10 (1-10V)	D 15WP* ***	25€
1-3 x 1 side	DA (DALI)	D 15WDA EU ***	28€
1-3 x 1 side	DA (DALI)	D 15WDA US***	28€
2-8 x 1 side	PU (PUSH-DIM) + DA (DALI) + I-10 (1-10V)	D 40WDP* ***	57€
1 x 2 sides	NO (non-dimmable)	N 12W**	23€
1 x 2 sides	LC (TRIAC/IGBT)	D 10WT ***	18€
1 x 2 sides	PU (PUSH-DIM) + I-10 (1-10V)	D 15WP* ***	25€
1 x 2 sides	DA (DALI)	D 15WDA* ***	28€
1-4 x 2 sides	PU (PUSH-DIM) + DA (DALI) + I-10 (1-10V)	D 40WDP* ***	57€

For warranty use only Trizo21® supplied LED drivers as mentioned.  
 For all specs and techs about drivers, see [www.trizo21.com/drivers](http://www.trizo21.com/drivers)

driver remote mounting: driver does not fit through cutout hole of fixture  
 \*\*110V-230V \*\*IP65  
 \*\*\*driver fits behind optional cover for CODE W LED

# Track



## 2THIRTY

2Thirty Track 48V	146
2Thirty Track 230V	146

---



## AUDY-SOLITAIRE

Audy-Solitaire RF 75 Track 48V	149
Audy-Solitaire RF 100 Track 48V	150

---



## AUSTERE-SOLITAIRE

Austere-Solitaire RF 75 Track 48V	151
Austere-Solitaire RF 100 Track 48V	152

---



## AUDETTE

Audette Track 48V	147
Audette-Duo Track 48V	148
Audette-Varié Track 48V	148

---



## AUST-IN

Aust-In Adjustable Track 48V	151
------------------------------	-----

---



## MINI-PI

Mini-Pi 1 Track 48V	152
Mini-Pi 2 Track 48V	153

---



# Track



## T-PATH SURFACE MOUNTING

T-Path profil	154
T-Path Base	154
T-Path Driver	154
T-Path profile cover	154
T-Path E-connector 180°	155
T-Path M-connector 180°	155
T-Path E-connector 90° INTERNAL	155
T-Path E-connector 90° EXTERNAL	155
T-Path E-connector flexibel	156
T-Path Endplates	156
T-Path Endplates open	156
T-Path power feed	156
T-Path suspension kit	157

---



## T-PATH RIMLESS MOUNTING

T-Path profile	158
T-Path profile cover	158
T-Path E-connector 180°	158
T-Path E-connector flexibel	158
T-Path M-connector 180°	159
T-Path Endplates	159
T-Path power feed	159

---

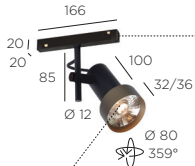

**! driver not incl. in adapter  
see required driver for adapter 48V**

**Choose beam:**

- N=narrow 12° or
- M=medium 24° or
- W=wide 40°

# 2Thirty Track 48V

48V - adapter included - **driver required for adapter 48V see below**

1 x LED array 11,8W (LED incl.) - 350mA - 1241lm - 2700K - CRI >97

TRACK 48V -

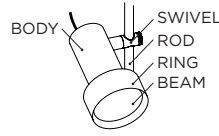

	ROD black	BODY black	SWIVEL black	RING black	ROD black	BODY black	SWIVEL black	RING bronze	ROD black	BODY black	SWIVEL black	RING gold	RETAIL PRICE VAT. EXCL.
	●	●	●	●	●	●	●	●	●	●	●	●	
		2T4 12723	◆			2T4 17723	◆			2T4 18723	◆		400€
<b>+ honeycomb</b>		2T4 12723H	◆			2T4 17723H	◆			2T4 18723H	◆		420€

## REQUIRED DRIVER FOR ADAPTER 48V (ASSEMBLED IN ADAPTER)

DEVICE	DIM.	DRIVER	NET PRICE
1 x	(non-dimmable)	N 14W	27€
1 x	(1-10V)	D 13WP	30€
1 x	(DALI)	D 13WD	34€

For warranty use only Trizo21® supplied LED drivers as mentioned. For all specs and techs about drivers, see [www.trizo21.com/drivers](http://www.trizo21.com/drivers)

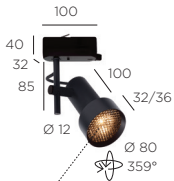

**Choose beam:**

- N=narrow 12° or
- M=medium 24° or
- W=wide 40°

# 2Thirty Track 230V

230V - (TRIAC/IGBT) dimmable

1 x LED Module 10W (LED incl.) - 230V - 1000lm - 2700K - CRI >90

TRACK 230V -

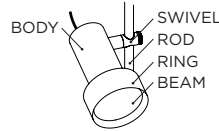

	ROD black	BODY black	SWIVEL black	RING black	ROD black	BODY black	SWIVEL black	RING bronze	ROD black	BODY black	SWIVEL black	RING gold	RETAIL PRICE VAT. EXCL.
	●	●	●	●	●	●	●	●	●	●	●	●	
		2T2 12223	◆			2T2 17223	◆			2T2 18223	◆		480€
<b>+ honeycomb</b>		2T2 12223H	◆			2T2 17223H	◆			2T2 18223H	◆		500€

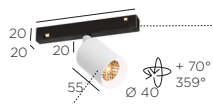

◆ Choose beam:  
M=medium 23°  
or W=wide 40°

# Audette Track 48V

48V - adapter included - driver required for adapter 48V see below

1 x LED array 6.25W (LED incl.) - 350mA - 2700K (633lm) or 3000K (673lm) - CRI >95

TRACK 48V -

		COLOR LED				COLOR LED																
		ADAPTER black	SWIVEL brass	BODY brass	RING brass	ADAPTER white	SWIVEL brass	BODY brass	RING brass	ADAPTER black	SWIVEL gunmetal	BODY gunmetal	RING gunmetal	ADAPTER black	SWIVEL bronze	BODY bronze	RING bronze	ADAPTER black	SWIVEL nickel	BODY nickel	RING nickel	RETAIL PRICE VAT. EXCL.
	2700K	◆	◆	◆	◆	◆	◆	◆	◆	◆	◆	◆	◆	◆	◆	◆	◆	◆	◆	◆	◆	335€
	2700K									◆				◆				◆				315€
	3000K	◆	◆	◆	◆	◆	◆	◆	◆	◆	◆	◆	◆	◆	◆	◆	◆	◆	◆	◆	◆	335€
	3000K									◆				◆				◆				315€
+ honeycomb	2700K	◆	◆	◆	◆	◆	◆	◆	◆		◆	◆	◆	◆	◆	◆	◆	◆	◆	◆	◆	345€
+ honeycomb	2700K									◆	◆	◆	◆	◆	◆	◆	◆	◆	◆	◆	◆	325€
+ honeycomb	3000K	◆	◆	◆	◆	◆	◆	◆	◆		◆	◆	◆	◆	◆	◆	◆	◆	◆	◆	◆	345€
+ honeycomb	3000K									◆	◆	◆	◆	◆	◆	◆	◆	◆	◆	◆	◆	325€
	2700K									◆	◆	◆	◆	◆	◆	◆	◆	◆	◆	◆	◆	400€
	3000K									◆	◆	◆	◆	◆	◆	◆	◆	◆	◆	◆	◆	400€
+ honeycomb	2700K	◆	◆	◆	◆	◆	◆	◆	◆	◆	◆	◆	◆	◆	◆	◆	◆	◆	◆	◆	◆	400€
+ honeycomb	3000K	◆	◆	◆	◆	◆	◆	◆	◆	◆	◆	◆	◆	◆	◆	◆	◆	◆	◆	◆	◆	400€

## REQUIRED DRIVER FOR ADAPTER 48V (ASSEMBLED IN ADAPTER)

DEVICE	DIM.	DRIVER	NET PRICE
1 x	NO (non-dimmable)	N 14W	27€
1 x	HO (1-10V)	D 13WP	30€
1 x	DA (DALI)	D 13WD	34€

For warranty use only Trizo21® supplied LED drivers as mentioned. For all specs and techs about drivers, see [www.trizo21.com/drivers](http://www.trizo21.com/drivers)

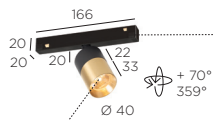

driver not incl. in adapter see required driver for adapter 48V

Choose beam:  
M=medium 23°  
or W=wide 40°

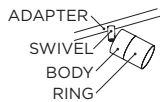

# Audette-Duo Track 48V

48V - adapter included - driver required for adapter 48V see below  
1 x LED array 6.25W (LED incl.) - 350mA - 2700K (633lm) or 3000K (673lm) - CRI >95  
TRACK 48V -

	COLOR LED	ADAPTER black	SWIVEL brass	BODY brass	RING black	ADAPTER black	SWIVEL brass	BODY brass	RING white	ADAPTER white	SWIVEL brass	BODY brass	RING white	ADAPTER black	SWIVEL black	BODY black	RING brass	ADAPTER black	SWIVEL white	BODY white	RING brass	ADAPTER white	SWIVEL white	BODY white	RING brass	RETAIL PRICE VAT. EXCL.
	2700K	●	●	●	●	●	●	●	○	○	●	●	○	●	●	●	●	●	○	○	○	○	○	○	○	315€
	2700K																								335€	
	3000K	●	●	●	●	●	●	●	○	○	●	●	○	●	●	●	●	●	○	○	○	○	○	○	315€	
	3000K																								335€	
+ honeycomb	2700K	●	●	●	●	●	●	●	○	○	●	●	○	●	●	●	●	●	○	○	○	○	○	○	325€	
+ honeycomb	2700K																								335€	
+ honeycomb	3000K	●	●	●	●	●	●	●	○	○	●	●	○	●	●	●	●	●	○	○	○	○	○	○	325€	
+ honeycomb	3000K																								335€	

## REQUIRED DRIVER FOR ADAPTER 48V (ASSEMBLED IN ADAPTER)

DEVICE	DIM.	DRIVER	NET PRICE
1 x	NO (non-dimmable)	N 14W	27€
1 x	HO (1-10V)	D 13WP	30€
1 x	DA (DALI)	D 13WD	34€

For warranty use only Trizo21® supplied LED drivers as mentioned. For all specs and techs about drivers, see [www.trizo21.com/drivers](http://www.trizo21.com/drivers)

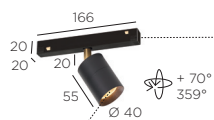

driver not incl. in adapter see required driver for adapter 48V

Choose beam:  
M=medium 23°  
or W=wide 40°

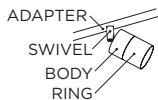

# Audette-Varié Track 48V

48V - adapter included - driver required for adapter 48V see below  
1 x LED array 6.25W (LED incl.) - 350mA - 2700K (633lm) or 3000K (673lm) - CRI >95  
TRACK 48V -

	COLOR LED	ADAPTER black	SWIVEL brass	BODY black	RING black	ADAPTER black	SWIVEL brass	BODY white	RING white	ADAPTER white	SWIVEL brass	BODY white	RING white	RETAIL PRICE VAT. EXCL.
	2700K	●	●	●	●	●	●	○	○	○	●	○	○	315€
	3000K	●	●	●	●	●	●	○	○	○	●	○	○	315€
+ honeycomb	2700K	●	●	●	●	●	●	○	○	○	●	○	○	325€
+ honeycomb	3000K	●	●	●	●	●	●	○	○	○	●	○	○	325€

## REQUIRED DRIVER FOR ADAPTER 48V (ASSEMBLED IN ADAPTER)

DEVICE	DIM.	DRIVER	NET PRICE
1 x	NO (non-dimmable)	N 14W	27€
1 x	HO (1-10V)	D 13WP	30€
1 x	DA (DALI)	D 13WD	34€

For warranty use only Trizo21® supplied LED drivers as mentioned. For all specs and techs about drivers, see [www.trizo21.com/drivers](http://www.trizo21.com/drivers)

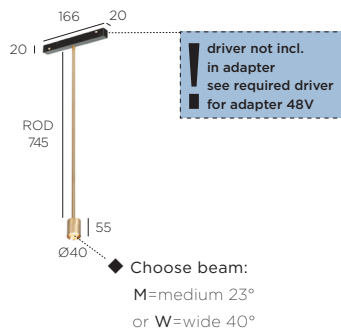

# Audy-Solitaire RF 75 Track 48V

48V - adapter included - driver required for adapter 48V see below

1 x LED array 6.25W (LED incl.) - 350mA - 2700K (633lm) or 3000K (673lm) - CRI >95

TRACK 48V -

	COLOR LED	ADAPTER black FRAME brass	ADAPTER white FRAME brass	ADAPTER black FRAME black	ADAPTER white FRAME black	ADAPTER white FRAME white	RETAIL PRICE VAT. EXCL.
	2700K	AYTR 2703◆	AYTW 2703◆				560€
	2700K			AYTR 2702◆	AYTW 2702◆	AYTW 2701◆	540€
	3000K	AYTR 3703◆	AYTW 3703◆				560€
	3000K			AYTR 3702◆	AYTW 3702◆	AYTW 3701◆	540€
+ honeycomb	2700K	AYTR 2703H◆	AYTW 2703H◆				570€
+ honeycomb	2700K			AYTR 2702H◆	AYTW 2702H◆	AYTW 2701H◆	550€
+ honeycomb	3000K	AYTR 3703H◆	AYTW 3703H◆				570€
+ honeycomb	3000K			AYTR 3702H◆	AYTW 3702H◆	AYTW 3701H◆	550€
				COLOR LED			
				ADAPTER black FRAME gunmetal	ADAPTER black FRAME bronze	ADAPTER black FRAME nickel	RETAIL PRICE VAT. EXCL.
	2700K			AYTR 2704◆	AYTR 2707◆	AYTR 2709◆	630€
	3000K			AYTR 3704◆	AYTR 3707◆	AYTR 3709◆	630€
+ honeycomb	2700K			AYTR 2704H◆	AYTR 2707H◆	AYTR 2709H◆	640€
+ honeycomb	3000K			AYTR 3704H◆	AYTR 3707H◆	AYTR 3709H◆	640€

## REQUIRED DRIVER FOR ADAPTER 48V (ASSEMBLED IN ADAPTER)

DEVICE	DIM.	DRIVER	NET PRICE
1 x	(non-dimmable)	N 14W	27€
1 x	(1-10V)	D 13WP	30€
1 x	(DALI)	D 13WD	34€

For warranty use only Trizo21® supplied LED drivers as mentioned. For all specs and techs about drivers, see [www.trizo21.com/drivers](http://www.trizo21.com/drivers)

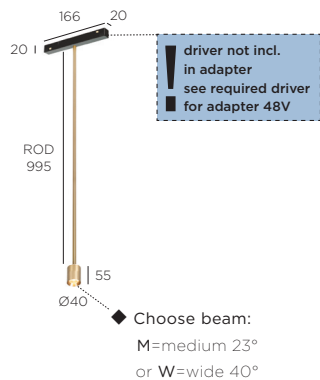

# Audy-Solitaire RF 100 Track 48V

48V - adapter included - **driver required for adapter 48V see below**

1 x LED array 6.25W (LED incl.) - 350mA - 2700K (633lm) or 3000K (673lm) - CRI >95

TRACK 48V -

	COLOR LED	ADAPTER black FRAME brass	ADAPTER white FRAME brass	ADAPTER black FRAME black	ADAPTER white FRAME black	ADAPTER white FRAME white	RETAIL PRICE VAT. EXCL.
	2700K	AYTR 2903◆	AYTW 2903◆				580€
	2700K			AYTR 2902◆	AYTW 2902◆	AYTW 2901◆	560€
	3000K	AYTR 3903◆	AYTW 3903◆				580€
	3000K			AYTR 3902◆	AYTW 3902◆	AYTW 3901◆	560€
+ honeycomb	2700K	AYTR 2903H◆	AYTW 2903H◆				590€
+ honeycomb	2700K			AYTR 2902H◆	AYTW2902H◆	AYTW 2901H◆	570€
+ honeycomb	3000K	AYTR 3903H◆	AYTW 3903H◆				590€
+ honeycomb	3000K			AYTR 3902H◆	AYTW 3902H◆	AYTW 3901H◆	570€
	COLOR LED	ADAPTER black FRAME gunmetal	ADAPTER black FRAME bronze	ADAPTER black FRAME nickel			RETAIL PRICE VAT. EXCL.
	2700K	AYTR 2904◆	AYTR 2907◆	AYTR 2909◆			650€
	3000K	AYTR 3904◆	AYTR 3907◆	AYTR 3909◆			650€
+ honeycomb	2700K	AYTR 2904H◆	AYTR 2907H◆	AYTR 2909H◆			660€
+ honeycomb	3000K	AYTR 3904H◆	AYTR 3907H◆	AYTR 3909H◆			660€

## REQUIRED DRIVER FOR ADAPTER 48V (ASSEMBLED IN ADAPTER)

DEVICE	DIM.	DRIVER	NET PRICE
1 x	NO (non-dimmable)	N 14W	27€
1 x	HO (1-10V)	D 13WP	30€
1 x	DA (DALI)	D 13WD	34€

For warranty use only Trizo21® supplied LED drivers as mentioned. For all specs and techs about drivers, see [www.trizo21.com/drivers](http://www.trizo21.com/drivers)

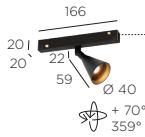

! driver not incl. in adapter see required driver for adapter 48V

# Aust-In Adjustable Track 48V

48V - adapter included - driver required for adapter 48V see below

1 x LED array 6W (LED incl.) - 350mA - 634lm - 2700K - CRI >93

TRACK 48V -

ADAPTER black FRAME brass 	ADAPTER white FRAME brass 	ADAPTER black FRAME black 	ADAPTER white FRAME black 	ADAPTER white FRAME white 	RETAIL PRICE VAT. EXCL.
AUTR 1733	AUTW 1733	AUTR 1722	AUTW 1722	AUTW 1711	305€
					RETAIL PRICE VAT. EXCL.
					RETAIL PRICE VAT. EXCL.
					RETAIL PRICE VAT. EXCL.
					RETAIL PRICE VAT. EXCL.

## REQUIRED DRIVER FOR ADAPTER 48V (ASSEMBLED IN ADAPTER)

DEVICE	DIM.	DRIVER	NET PRICE
1 x	NO (non-dimmable)	N 14W	27€
1 x	IHO (1-10V)	D 13WP	30€
1 x	DA (DALI)	D 13WD	34€

For warranty use only Trizo21® supplied LED drivers as mentioned. For all specs and techs about drivers, see [www.trizo21.com/drivers](http://www.trizo21.com/drivers)

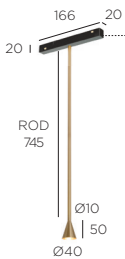

! driver not incl. in adapter see required driver for adapter 48V

# Austere-Solitaire RF 75 Track 48V

48V - adapter included - driver required for adapter 48V see below

1 x LED array 6W (LED incl.) - 350mA - 634lm - 2700K - CRI >93

TRACK 48V -

ADAPTER black FRAME brass 	ADAPTER white FRAME brass 	ADAPTER black FRAME black 	ADAPTER white FRAME black 	ADAPTER white FRAME white 	RETAIL PRICE VAT. EXCL.
HVSU 4773	HVSW 4773	HVSU 4772	HVSW 4772	HVSW 4771	470€
					RETAIL PRICE VAT. EXCL.
					RETAIL PRICE VAT. EXCL.
					RETAIL PRICE VAT. EXCL.
					RETAIL PRICE VAT. EXCL.

## REQUIRED DRIVER FOR ADAPTER 48V (ASSEMBLED IN ADAPTER)

DEVICE	DIM.	DRIVER	NET PRICE
1 x	NO (non-dimmable)	N 14W	27€
1 x	IHO (1-10V)	D 13WP	30€
1 x	DA (DALI)	D 13WD	34€

For warranty use only Trizo21® supplied LED drivers as mentioned. For all specs and techs about drivers, see [www.trizo21.com/drivers](http://www.trizo21.com/drivers)

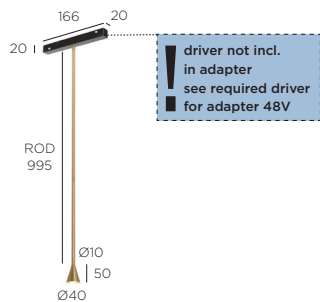

# Austere-Solitaire RF 100 Track 48V

48V - adapter included - **driver required for adapter 48V see below**  
 1 x LED array 6W (LED incl.) - 350mA - 634lm - 2700K - CRI >93  
**TRACK 48V** -

ADAPTER black FRAME brass 	ADAPTER white FRAME brass 	ADAPTER black FRAME black 	ADAPTER white FRAME black 	ADAPTER white FRAME white 	RETAIL PRICE VAT. EXCL.
HVSU 4793	HVSW 4793	HVSU 4792	HVSW 4792	HVSW 4791	490€
					RETAIL PRICE VAT. EXCL.
					RETAIL PRICE VAT. EXCL.
					RETAIL PRICE VAT. EXCL.
					RETAIL PRICE VAT. EXCL.
					RETAIL PRICE VAT. EXCL.

## REQUIRED DRIVER FOR ADAPTER 48V (ASSEMBLED IN ADAPTER)

DEVICE	DIM.	DRIVER	NET PRICE
1 x	NO (non-dimmable)	N 14W	27€
1 x	1-10 (1-10V)	D 13WP	30€
1 x	DA (DALI)	D 13WD	34€

For warranty use only Trizo21® supplied LED drivers as mentioned. For all specs and techs about drivers, see [www.trizo21.com/drivers](http://www.trizo21.com/drivers)

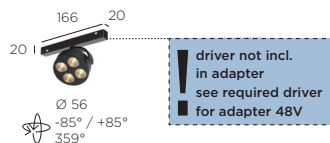

- ◆ Choose beam:
- N=narrow 10° or
- M=medium 25° or
- W=wide 40°

# Mini-Pi 1 Track 48V

48V - adapter included - **driver required for adapter 48V see below**  
 1 x 4 LED 0,96W (LED incl.) - 350mA - 456lm - 2700K - CRI >93  
**TRACK 48V** -

ADAPTER black FRAME black 	ADAPTER black FRAME white 	ADAPTER white FRAME white 	RETAIL PRICE VAT. EXCL.
MIPI 4712◆	MIPI 4711◆	MIPW 4711◆	300€

## REQUIRED DRIVER FOR ADAPTER 48V (ASSEMBLED IN ADAPTER)

DEVICE	DIM.	DRIVER	NET PRICE
1 x	NO (non-dimmable)	N 14W	27€
1 x	1-10 (1-10V)	D 13WP	30€
1 x	DA (DALI)	D 13WD	34€

For warranty use only Trizo21® supplied LED drivers as mentioned. For all specs and techs about drivers, see [www.trizo21.com/drivers](http://www.trizo21.com/drivers)





**!** driver not incl. in adapter see required driver for adapter 48V

- ◆ Choose beam:  
N=narrow 10° or  
M=medium 25° or  
W=wide 40°

# Mini-Pi 2 Track 48V

48V - adapter included - **driver required for adapter 48V see below**

2 x 4 LED 0.96W (LED incl.) - 350mA - 2 x 456lm - 2700K - CRI >93

TRACK 48V - IP40

ADAPTER black  
FRAME black



MIPI 4722 ◆

ADAPTER black  
FRAME white



MIPI 4721 ◆

ADAPTER white  
FRAME white



MIPW 4721 ◆

RETAIL PRICE  
VAT. EXCL.

535€

## REQUIRED DRIVER FOR ADAPTER 48V (ASSEMBLED IN ADAPTER)

DEVICE	DIM.	DRIVER	NET PRICE
1 x	NO (non-dimmable)	N 14W	27€
1 x	1-10V	D 13WP	30€
1 x	DALI	D 13WD	34€

For warranty use only Trizo21® supplied LED drivers as mentioned. For all specs and techs about drivers, see [www.trizo21.com/drivers](http://www.trizo21.com/drivers)

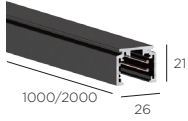

# T-Path profile 48V

48V - **driver required for T-Path** (T-Path base or T-Path driver)  
 TRACK 48V -

LENGTH	FRAME black	FRAME white	PROJECT PRICE ON REQUEST
1000	TPCM 1002	TPCM 1001	P.P. on request
2000	TPCM 2002	TPCM 2001	P.P. on request

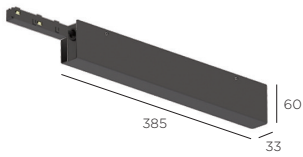

# T-Path base (built-up)

230V - **driver included in base** - **NO (non-dimmable)** max.100W  
 TRACK 48V -

NO	FRAME black	FRAME white	PROJECT PRICE ON REQUEST
	TPBA 2000	TPBA 1000	P.P. on request

# T-Path driver (built-in)

## REQUIRED DRIVER FOR REMOTE MOUNTING DRIVER T-PATH

DEVICE	DIM.	DRIVER	NET PRICE
1 x	<b>NO (non-dimmable)</b>	N 75W	on request
1 x	<b>NO (non-dimmable)</b>	N 150W	on request
1 x	<b>NO (non-dimmable)</b>	N 240W	on request

For warranty use only Trizo21® supplied LED drivers as mentioned. For all specs and techs about drivers, see [www.trizo21.com/drivers](http://www.trizo21.com/drivers)

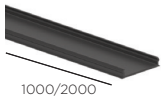

# T-Path profile cover

LENGTH	FRAME black	FRAME white	PROJECT PRICE ON REQUEST
1000	TPCO 1002	TPCO 1001	P.P. on request
2000	TPCO 2002	TPCO 2001	P.P. on request

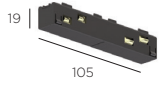

# T-Path E-connector 180° 48V

48V  
TRACK 48V -

FRAME black



TPEC 1802

FRAME white



TPEC 1801

| P.P. on request

PROJECT PRICE  
ON REQUEST

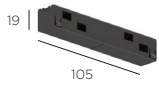

# T-Path M-connector 180° 48V

48V  
TRACK 48V -

FRAME black



TPMC 1802

FRAME white



TPMC 1801

| P.P. on request

PROJECT PRICE  
ON REQUEST

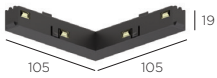

# T-Path E-connector 90° INTERNAL 48V

48V  
TRACK 48V -

FRAME black



TPCI 0902

FRAME white



TPCI 0901

| P.P. on request

PROJECT PRICE  
ON REQUEST

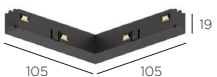

# T-Path E-connector 90° EXTERNAL 48V

48V  
TRACK 48V -

FRAME black



TPCE 0902

FRAME white



TPCE 0901

| P.P. on request

PROJECT PRICE  
ON REQUEST



# T-Path E-connector flexibel 48V

48V  
TRACK 48V - eco

FRAME black



TPEF 0002

FRAME white



TPEF 0001

| P.P. on request

PROJECT PRICE  
ON REQUEST

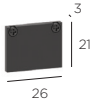

# T-Path Endplate

FRAME black



TPEP 2002

FRAME white



TPEP 2001

| P.P. on request

PROJECT PRICE  
ON REQUEST

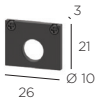

# T-Path Endplate open

FRAME black



TPOP 2002

FRAME white



TPOP 2001

| P.P. on request

PROJECT PRICE  
ON REQUEST

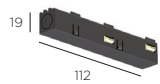

# T-Path power feed left

48V  
TRACK 48V - eco

FRAME black



TPPL 1002

FRAME white



TPPL 1001

| P.P. on request

PROJECT PRICE  
ON REQUEST

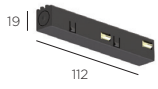

# T-Path power feed right

48V  
TRACK 48V - eco

FRAME black

FRAME white

PROJECT PRICE  
ON REQUEST

TPPR 1002

TPPR 1001

| P.P. on request

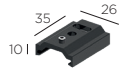

# T-Path suspension kit

FRAME black

FRAME white

PROJECT PRICE  
ON REQUEST

TPSU 0002

TPSU 0001

| P.P. on request



# T-Path canopy B10

FRAME black

FRAME white

PROJECT PRICE  
ON REQUEST

21CP 2002

21CP 1001

| P.P. on request

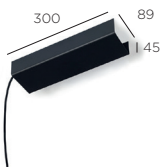

# T-Path base SU

FRAME black

FRAME white

PROJECT PRICE  
ON REQUEST

21BO 0002

21BO 0001

| P.P. on request

# T-Path profile 48V

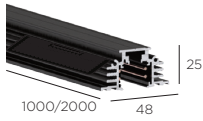

48V - **required remote mounted driver**  
 Bracket for rimless mounting incl. (4 pieces / meter)  
**TRACK 48V** -

LENGTH	FRAME black	PROJECT PRICE ON REQUEST
1000	TPRI 1002	P.P. on request
2000	TPRI 2002	P.P. on request

## REQUIRED DRIVER FOR REMOTE MOUNTING DRIVER T-PATH

DEVICE	DIM.	DRIVER	NET PRICE
1 x	(non-dimmable)	N 75W	on request
1 x	(non-dimmable)	N 150W	on request
1 x	(non-dimmable)	N 240W	on request

For warranty use only Trizo21® supplied LED drivers as mentioned. For all specs and techs about drivers, see [www.trizo21.com/drivers](http://www.trizo21.com/drivers)

# T-Path profile cover

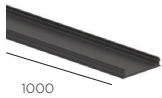

LENGTH	FRAME black	FRAME white	PROJECT PRICE ON REQUEST
1000	TPCO 1002	TPCO 1001	P.P. on request

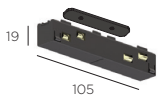

# T-Path E-connector 180° 48V

48V  
**TRACK 48V** -

FRAME black	PROJECT PRICE ON REQUEST
TPREC 1802	P.P. on request



# T-Path E-connector flexibel 48V

48V  
**TRACK 48V** -

FRAME black	PROJECT PRICE ON REQUEST
TPEF 0002	P.P. on request

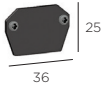

# T-Path Endplates (2 pieces)

FRAME black



PROJECT PRICE  
ON REQUEST

TPREP 0002 | P.P. on request

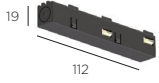

# T-Path power feed left

FRAME black



TPPL 1002

FRAME white



TPPL 1001

48V  
TRACK 48V -

PROJECT PRICE  
ON REQUEST

| P.P. on request

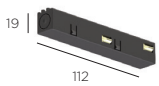

# T-Path power feed right

FRAME black



TPPR 1002

FRAME white



TPPR 1001

48V  
TRACK 48V -

PROJECT PRICE  
ON REQUEST

| P.P. on request

# Outdoor



**BILY OUT**

Bily 16 OUT

163

---



**AUDY OUT**

Audy-In OUT

162

---



**7TY OUT**

7Ty up OUT

162

---



**BILY UP OUT**

Bily 16 up OUT

163

---



# Outdoor



## CODE 1 OUT

Code 1 GU10 OUT	165
Code 1 LED OUT	165

---



## BOULY OUT

Bouly 4 OUT	164
Bouly 16 OUT	164

---



## CODE W OUT

Code W G9 OUT	166
Code W LED OUT	167

---



## CODE 2 OUT

Code 2 GU10 OUT	165
Code 2 LED OUT	166

---

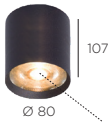

◆ Choose beam:  
 N=narrow 12° or  
 M=medium 24° or  
 W=wide 40°

# 7Ty up OUT

230V - driver included in base - **LC** (TRIAC/IGBT) dimmable  
 1 x LED array 11,8W (LED incl.) - 250mA - 913lm - 2700K - CRI >97  
**CEILING** -

DIM	FRAME black	FRAME white	FRAME bronze	FRAME gold	FRAME alu	RETAIL PRICE VAT. EXCL.
<b>LC</b>	STEP 1002◆	STEP 1001◆	STEP 1007◆	STEP 1008◆	STEP 1009◆	325€



FALSE & CONCRETE ceiling

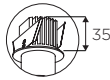

# Audy-In OUT

350mA - **required remote mounted driver see below**

1 x LED array 6,25W (incl.) - 350mA - 2700K (633lm) or 3000K (673lm) - 3000K - CRI >95

**FALSE ceiling** = aperture : Ø 45 - depth : min. 50 mm - depth for driver in false ceiling : min. 70 mm

**CONCRETE ceiling** = aperture : Ø 45 - depth : min. 50 mm - depth for driver in concrete ceiling : min. 110 mm

**CEILING** -

COLOR LED	FRAME black	FRAME white	RETAIL PRICE VAT. EXCL.
2700K	AUDEX 1272◆	AUDEX 1271◆	330€
3000K	AUDEX 1302◆	AUDEX 1301◆	330€

## REQUIRED REMOTE MOUNTED DRIVER

DEVICE	DIM.	DRIVER	NET PRICE
1 x	<b>LC</b> (TRIAC/IGBT)	D 6WT	14€
2 x	<b>LC</b> (TRIAC/IGBT)	<b>D 18WT</b>	22€
1-2 x	<b>PU</b> (PUSH-DIM) + <b>DA</b> (DALI)	<b>D 15WP*</b>	25€
1-2 x	<b>DA</b> (DALI)	D 15WDA EU	28€
1-2 x	<b>DA</b> (DALI)	<b>D 15WDA US*</b>	28€
2-6 x	<b>PU</b> (PUSH-DIM) + <b>DA</b> (DALI) + <b>110</b> (1-10V)	<b>D 40WDP*</b>	54€

For warranty use only Trizo21® supplied LED drivers as mentioned.  
 For all specs and techs about drivers, see [www.trizo21.com/drivers](http://www.trizo21.com/drivers)

driver remote mounting: driver does not fit through cutout hole of fixture  
 \*110V-230V

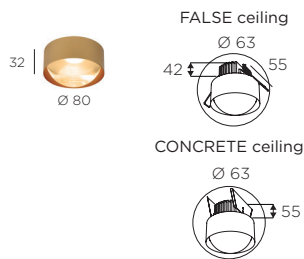

# Bily 16 OUT

350mA - **required remote mounted driver see below**

1 x LED array 11W (incl.) - 350mA - 1125lm - 2700K - CRI >97

**FALSE ceiling** = aperture : Ø 65 - depth : min. 50 mm - depth for driver in ceiling : min. 70 mm

**CONCRETE ceiling** = aperture : Ø 65 - depth : min. 70 mm - depth for driver in ceiling : min. 130 mm

CEILING -

			FRAME black	FRAME white	FRAME bronze	FRAME gold	FRAME alu	RETAIL PRICE VAT. EXCL.
FALSE ceiling	silver LED HOLDER		BIEXF 1620	BIEXF 1610	BIEXF 1670	BIEXF 1680	BIEXF 1690	460€
FALSE ceiling	gold LED HOLDER		BIEXF 1628	BIEXF 1618	BIEXF 1678	BIEXF 1688	BIEXF 1698	470€
CONCRETE ceiling	silver LED HOLDER		BIEXC 1620	BIEXC 1610	BIEXC 1670	BIEXC 1680	BIEXC 1690	470€
CONCRETE ceiling	gold LED HOLDER		BIEXC 1628	BIEXC 1618	BIEXC 1678	BIEXC 1688	BIEXC 1698	480€

## REQUIRED REMOTE MOUNTED DRIVER

DEVICE	DIM.	DRIVER	NET PRICE
1 x	(non-dimmable)	N 12W**	23€
1 x	(TRIAC/IGBT)	D 18WT	22€
1 x	(PUSH-DIM) +  (1-10V)	D 15WP*	25€
1 x	(DALI)	D 15WDA EU	28€
1 x	(DALI)	D 15WDA US*	28€
1-3 x	(PUSH-DIM) +  (DALI) +  (1-10V)	D 40WDP*	57€

For warranty use only Trizo21® supplied LED drivers as mentioned.  
For all specs and techs about drivers, see [www.trizo21.com/drivers](http://www.trizo21.com/drivers)

driver remote mounting: driver does not fit through cutout hole of fixture  
\*110V-230V \*\*IP 65



# Bily 16 up OUT

230V - driver included in base - (TRIAC/IGBT) dimmable

1 x LED array 11W (LED incl.) - 350mA - 1125lm - 2700K - CRI >97

CEILING -

			FRAME black	FRAME white	FRAME bronze	FRAME gold	FRAME alu	RETAIL PRICE VAT. EXCL.
		DIM						
	silver LED HOLDER		BUEX 1620	BUEX 1610	BUEX 1670	BUEX 1680	BUEX 1690	555€
	gold LED HOLDER		BUEX 1628	BUEX 1618	BUEX 1678	BUEX 1688	BUEX 1698	565€



◆ Choose beam:  
 N=narrow 10° or  
 M=medium 25° or  
 W=wide 40°

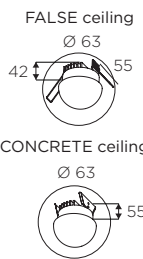

# Bouly 4 OUT

350mA - **required remote mounted driver see below**

1 x 4 LED 0.96W (LED incl.) - 350mA - 456lm - 2700K - CRI >93

FALSE ceiling = aperture : Ø 65 - depth : min. 50 mm - depth for driver in ceiling : min. 70 mm  
 CONCRETE ceiling = aperture : Ø 65 - depth : min. 60 mm - depth for driver in ceiling : min. 130 mm

CEILING - CE IP55

RETAIL PRICE  
VAT. EXCL.

FALSE ceiling	silver LED HOLDER	BEWW 6010◆	415€
CONCRETE ceiling	silver LED HOLDER	BEWW 6012◆	425€

## REQUIRED REMOTE MOUNTED DRIVER

DEVICE	DIM.	DRIVER	NET PRICE
1 x	NO (non-dimmable)	N 5W	11€
1 x	C (IGBT)	D 6WI	13€
1 x	PU (PUSH-DIM) + 1-10 (1-10V)	D 6WP	14€
1-2 x	NO (non-dimmable)	N 12W**	23€
1-3 x	PU (PUSH-DIM) + 1-10 (1-10V)	D 15WP*	25€
1-3 x	DA (DALI)	D 15 WDA EU	28€
1-3 x	DA (DALI)	D 15WDA US*	28€
2-8 x	PU (PUSH-DIM) + DA (DALI) + 1-10 (1-10V)	D 40WDP*	57€

For warranty use only Trizo21® supplied LED drivers as mentioned.  
 For all specs and techs about drivers, see [www.trizo21.com/drivers](http://www.trizo21.com/drivers)

driver remote mounting: driver does not fit through cutout hole of fixture  
 \*110V-230V \*\*IP 65

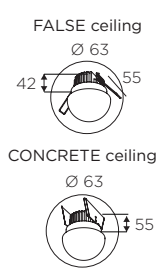

# Bouly 16 OUT

350mA - **required remote mounted driver see below**

1 x LED array 11W (LED incl.) - 350mA - 1125lm - 2700K - CRI >97

FALSE ceiling = aperture : Ø 65 - depth : min. 50 mm - depth for driver in ceiling : min. 70 mm  
 CONCRETE ceiling = aperture : Ø 65 - depth : min. 70 mm - depth for driver in ceiling : min. 130 mm

CEILING - CE IP55

RETAIL PRICE  
VAT. EXCL.

FALSE ceiling	silver LED HOLDER	BOEX 1600	425€
FALSE ceiling	gold LED HOLDER	BOEX 1608	440€
CONCRETE ceiling	silver LED HOLDER	BOEX 1602	435€
CONCRETE ceiling	gold LED HOLDER	BOEX 1680	455€

## REQUIRED REMOTE MOUNTED DRIVER

DEVICE	DIM.	DRIVER	NET PRICE
1 x	NO (non-dimmable)	N 12W**	23€
1 x	LC (TRIAC/IGBT)	D 18WT	22€
1 x	PU (PUSH-DIM) + 1-10 (1-10V)	D 15WP*	25€
1 x	DA (DALI)	S 15WDA EU	28€
1 x	DA (DALI)	D 15WDA US*	28€
1-3 x	PU (PUSH-DIM) + DA (DALI) + 1-10 (1-10V)	D 40WDP*	57€

For warranty use only Trizo21® supplied LED drivers as mentioned.  
 For all specs and techs about drivers, see [www.trizo21.com/drivers](http://www.trizo21.com/drivers)

driver remote mounting: driver does not fit through cutout hole of fixture  
 \*110V-230V \*\*IP 65



# Code 1 GU10 OUT

230V - GU10 - 1 x HALO QPAR16 max. 35W or 1 x GU10 LED  
**Bulb excluded - CEILING** -

FRAME black



COEX 3001

FRAME white



COEX 1001

FRAME alu



COEX 2001

RETAIL PRICE  
VAT. EXCL.

240€

OPTIONAL COVER CODE 1 BATHROOM & CODE 1 LED BATHROOM

ACEX 7055

ACEX 2055

ACEX 1055

50€



◆ Choose beam:  
 N=narrow 10° or  
 M=medium 25° or  
 W=wide 40°

# Code 1 LED OUT

230V - driver included in base - non-dimmable  
 1 x 4 LED 0.96W (LED incl.) - 350mA - 456lm - 2700K - CRI >93  
**CEILING** -

FRAME black



COEX 2151◆

FRAME white



COEX 1151◆

FRAME alu



COEX 7151◆

RETAIL PRICE  
VAT. EXCL.

405€

OPTIONAL COVER CODE 1 BATHROOM & CODE 1 LED BATHROOM

ACEX 7055

ACEX 2055

ACEX 1055

50€



# Code 2 GU10 OUT

230V - GU10 - 2 x HALO QPAR16 max. 35W or 2 x GU10 LED  
**Bulbs excluded - CEILING** -

FRAME black



COEX 3002

FRAME white



COEX 1002

FRAME alu



COEX 2002

RETAIL PRICE  
VAT. EXCL.

290€

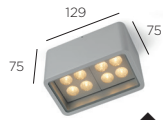

◆ Choose beam:  
 N=narrow 10° or  
 M=medium 25° or  
 W=wide 40°

# Code 2 LED OUT

230V - driver included in base - non-dimmable  
 1 x 8 LED 0.96W (LED incl.) - 350mA - 912lm - 2700K - CRI >93  
 CEILING -

FRAME black 	FRAME white 	FRAME alu 	RETAIL PRICE VAT. EXCL.
COEX 2251◆	COEX 1251◆	COEX 7251◆	635€

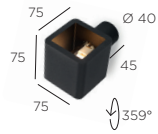

# Code W G9 OUT

230V - G9 - 1 x HALO QT14 max. 60W or 1 x G9 LED (max. Ø19, max. L 62mm)  
 Bulb excluded - WALL -

FRAME black 	FRAME white 	FRAME alu 	RETAIL PRICE VAT. EXCL.
230V - G9 HALO   CODE 2006	CODE 1006	CODE 7006	225€
230V - G9 LED   CODE L2006	CODE L1006	CODE L7006	225€

OPTIONAL COVER FOR CODE W BATHROOM

ACEX 2006	ACEX 1006	ACEX 7006	50€
-----------	-----------	-----------	-----



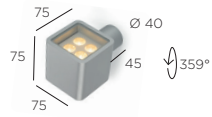

- ◆ Choose beam:  
 N=narrow 10° or  
 M=medium 25° or  
 W=wide 40°

# Code W LED OUT

350mA - **required remote mounted driver see below**

1 lighting side : 1 x 4 LED 0.96W (LED incl.) - 350mA - 456lm - 2700K - CRI >93  
 2 lighting sides : 2 x 4 LED 0.96W (LED incl.) - 350mA - 2 x 456lm - 2700K - CRI >93  
 WALL - CE RoHS IP55 eco

FRAME black



FRAME white



FRAME alu



RETAIL PRICE  
VAT. EXCL.

1 side	COEX 2111◆	COEX 1111◆	COEX 7111◆		475€
2 sides	COEX 2211◆	COEX 1211◆	COEX 7211◆		665€



OPTIONAL COVER FOR CODE W LED BATHROOM

ACEX 2006	ACEX 1006	ACEX 7006		50€
-----------	-----------	-----------	--	-----

## REQUIRED REMOTE MOUNTED DRIVER

DEVICE	DIM.	DRIVER	NET PRICE
1 x 1 side	NO (non-dimmable)	N 5W ***	11€
1 x 1 side	C (IGBT)	D 6WI ***	13€
1 x 1 side	PU (PUSH-DIM) + 1-10 (1-10V)	D 6WP ***	14€
1-2 x 1 side	NO (non-dimmable)	N 12W**	23€
2 x 1 side	LC (TRIAC/IGBT)	D 10WT ***	18€
1-3 x 1 side	PU (PUSH-DIM) + 1-10 (1-10V)	D 15WP* ***	25€
1-3 x 1 side	DA (DALI)	D 15WDA EU ***	28€
1-3 x 1 side	DA (DALI)	D 15WDA US***	28€
2-8 x 1 side	PU (PUSH-DIM) + DA (DALI) + 1-10 (1-10V)	D 40WDP* ***	57€
1 x 2 sides	NO (non-dimmable)	N 12W**	23€
1 x 2 sides	LC (TRIAC/IGBT)	D 10WT ***	18€
1 x 2 sides	PU (PUSH-DIM) + 1-10 (1-10V)	D 15WP* ***	25€
1 x 2 sides	DA (DALI)	D 15WDA* ***	28€
1-4 x 2 sides	PU (PUSH-DIM) + DA (DALI) + 1-10 (1-10V)	D 40WDP* ***	57€

For warranty use only Trizo21<sup>®</sup> supplied LED drivers as mentioned.  
 For all specs and techs about drivers, see [www.trizo21.com/drivers](http://www.trizo21.com/drivers)

driver remote mounting: driver does not fit through cutout hole of fixture  
 \*\*110V-230V \*\*\*IP 65  
 \*\*\*driver fits behind optional cover for CODE W LED

# Productcodes



1+ SU RF7 52222	103	1X RS 7013	89	2Y RF10 2222	81	3Y RL 22513	86	ACDE 3005	52	ADCC R6 2777H	119
1+ SU RF7 55222	103	1X RS 7022	88	2Y RF10 2223	81	3Y RL 22522	85	ACDE 3005	53	ADCC R6 2999	119
1+ SU RF7 52223	103	1X RS 7022	89	2Y RF10 2522	81	3Y RL 22522	86	ACDE 3010	51	ADCC R6 2999H	119
1+ SU RF7 55223	103	1X RS 7023	88	2Y RF10 2523	81	3Y RL 22523	85	ACDE 3010	51	ADCC R6 3111	119
1+ SU RF7 72222	103	1X RS 7023	89	2Y RF10 5522	81	3Y RL 22523	86	ACDE 7005	52	ADCC R6 3111H	119
1+ SU RF7 72223	103	1Y RF7 2022	78	2Y RF10 5523	81	3Y RL 25513	85	ACDE 7005	53	ADCC R6 3113	120
1+ SU RF7 75222	103	1Y RF7 2023	78	2Y RF10 5722	81	3Y RL 25513	86	ACDE 7010	51	ADCC R6 3113H	120
1+ SU RF7 75223	103	1Y RF7 5022	78	2Y RF10 5723	81	3Y RL 25522	85	ACDE 7010	51	ADCC R6 3222	119
1+ SU RF10 52222	103	1Y RF7 5023	78	2Y RF10 7722	81	3Y RL 25522	86	ACDE 9005	52	ADCC R6 3222H	119
1+ SU RF10 55222	103	1Y RF7 7022	78	2Y RF10 7723	81	3Y RL 25523	85	ACDE 9005	53	ADCC R6 3223	120
1+ SU RF10 52223	103	1Y RF7 7023	78	2Y RL 2213	82	3Y RL 25523	86	ACDE 9010	51	ADCC R6 3223H	120
1+ SU RF10 55223	103	1Y RF10 2022	78	2Y RL 2213	83	3Y RL 25713	85	ACDE 9010	51	ADCC R6 3331	120
1+ SU RF10 72222	103	1Y RF10 2023	78	2Y RL 2222	82	3Y RL 25713	86	ACEX 1006	142	ADCC R6 3331H	120
1+ SU RF10 72223	103	1Y RF10 5022	78	2Y RL 2222	83	3Y RL 25722	85	ACEX 1006	143	ADCC R6 3332	120
1+ SU RF10 75223	103	1Y RF10 5023	78	2Y RL 2223	82	3Y RL 25722	86	ACEX 1006	166	ADCC R6 3332H	120
1+ SU RF10 75222	103	1Y RF10 7022	78	2Y RL 2223	83	3Y RL 25723	85	ACEX 1006	167	ADCC R6 3333	119
1+ SU RL 52213	104	1Y RF10 7023	78	2Y RL 2513	82	3Y RL 25723	86	ACEX 1055	141	ADCC R6 3333H	119
1+ SU RL 52213	105	1Y RL 2013	79	2Y RL 2513	83	3Y RL 25713	85	ACEX 1055	141	ADCC R6 3444	119
1+ SU RL 52222	104	1Y RL 2013	80	2Y RL 2522	82	3Y RL 25713	86	ACEX 1055	165	ADCC R6 3444H	119
1+ SU RL 52222	105	1Y RL 2022	79	2Y RL 2522	83	3Y RL 55722	85	ACEX 1055	165	ADCC R6 3777	119
1+ SU RL 52223	104	1Y RL 2022	80	2Y RL 2523	82	3Y RL 55722	86	ACEX 2006	142	ADCC R6 3777H	119
1+ SU RL 55223	104	1Y RL 2023	79	2Y RL 2523	83	3Y RL 55723	85	ACEX 2006	143	ADCC R6 3999	119
1+ SU RL 52223	105	1Y RL 2023	80	2Y RL 5513	82	3Y RL 55723	86	ACEX 2006	166	ADCC R6 3999H	119
1+ SU RL 55223	105	1Y RL 5013	79	2Y RL 5513	83	3Y RL 57713	85	ACEX 2006	167	ADFC 2111	116
1+ SU RL 55213	104	1Y RL 5013	80	2Y RL 5522	82	3Y RL 57713	86	ACEX 2055	141	ADFC 2111H	116
1+ SU RL 55213	105	1Y RL 5022	79	2Y RL 5522	83	3Y RL 57722	85	ACEX 2055	141	ADFC 2222	116
1+ SU RL 55222	104	1Y RL 5022	80	2Y RL 5523	82	3Y RL 57722	86	ACEX 2055	165	ADFC 2222H	116
1+ SU RL 55222	105	1Y RL 5023	79	2Y RL 5523	83	3Y RL 57723	85	ACEX 2055	165	ADFC 2333	116
1+ SU RL 72213	104	1Y RL 5023	80	2Y RL 5713	82	3Y RL 57723	86	ACEX 7006	142	ADFC 2333H	116
1+ SU RL 72213	105	1Y RL 7013	79	2Y RL 5713	83	3Y RS 22513	85	ACEX 7006	143	ADFC 2444	116
1+ SU RL 72222	104	1Y RL 7013	80	2Y RL 5722	82	3Y RS 22513	86	ACEX 7006	166	ADFC 2444H	116
1+ SU RL 75222	104	1Y RL 7022	79	2Y RL 5722	83	3Y RS 22522	85	ACEX 7006	167	ADFC 2777	116
1+ SU RL 72222	105	1Y RL 7022	80	2Y RL 5723	82	3Y RS 22522	86	ACEX 7055	141	ADFC 2777H	116
1+ SU RL 75222	105	1Y RL 7023	79	2Y RL 5723	83	3Y RS 22523	85	ACEX 7055	141	ADFC 2999	116
1+ SU RL 72223	104	1Y RL 7023	80	2Y RL 7713	82	3Y RS 22523	86	ACEX 7055	165	ADFC 2999H	116
1+ SU RL 75223	104	1Y RS 2013	79	2Y RL 7713	83	3Y RS 25513	85	ACEX 7055	165	ADFC 3111	116
1+ SU RL 72223	105	1Y RS 2013	80	2Y RL 7722	82	3Y RS 25513	86	ACIN L001	122	ADFC 3111H	116
1+ SU RL 75223	105	1Y RS 2022	79	2Y RL 7722	83	3Y RS 25522	85	ACIN L002	122	ADFC 3222	116
1+ SU RL 75213	104	1Y RS 2022	80	2Y RL 7723	82	3Y RS 25522	86	ACIN L003	122	ADFC 3222H	116
1+ SU RL 75213	105	1Y RS 2023	79	2Y RL 7723	83	3Y RS 25523	85	ACIN L004	122	ADFC 3333	116
1+ SU RS 52213	104	1Y RS 2023	80	2Y RS 2213	82	3Y RS 25523	86	ACIN L007	122	ADFC 3333H	116
1+ SU RS 52213	105	1Y RS 5013	79	2Y RS 2213	83	3Y RS 25713	85	ACIN L009	122	ADFC 3444	116
1+ SU RS 52222	104	1Y RS 5013	80	2Y RS 2222	82	3Y RS 25713	86	ADCC 2111	116	ADFC 3444H	116
1+ SU RS 55222	104	1Y RS 5022	79	2Y RS 2222	83	3Y RS 25722	85	ADCC 2111H	116	ADFC 3777	116
1+ SU RS 52222	105	1Y RS 5022	80	2Y RS 2223	82	3Y RS 25722	86	ADCC 2222	116	ADFC 3777H	116
1+ SU RS 55222	105	1Y RS 5023	79	2Y RS 2223	83	3Y RS 25723	85	ADCC 2222H	116	ADFC 3999	116
1+ SU RS 52223	104	1Y RS 5023	80	2Y RS 2513	82	3Y RS 25723	86	ADCC 2333	116	ADFC 3999H	116
1+ SU RS 52223	105	1Y RS 7013	79	2Y RS 2513	83	3Y RS 55713	85	ADCC 2333H	116	ADFC 2113	117
1+ SU RS 55213	104	1Y RS 7013	80	2Y RS 2522	82	3Y RS 55713	86	ADCC 2444	116	ADFC 2113H	117
1+ SU RS 55213	105	1Y RS 7022	79	2Y RS 2522	83	3Y RS 55722	85	ADCC 2444H	116	ADFC 2131	118
1+ SU RS 55223	104	1Y RS 7022	80	2Y RS 2523	82	3Y RS 55722	86	ADCC 2777	116	ADFC 2131H	118
1+ SU RS 55223	105	1Y RS 7023	79	2Y RS 2523	83	3Y RS 55723	85	ADCC 2777H	116	ADFC 2223	117
1+ SU RS 72213	104	1Y RS 7023	80	2Y RS 5513	82	3Y RS 55723	86	ADCC 2999	116	ADFC 2223H	117
1+ SU RS 72213	105	2T2 12223	146	2Y RS 5513	83	3Y RS 57713	85	ADCC 2999H	116	ADFC 2232	118
1+ SU RS 75213	105	2T2 12223H	146	2Y RS 5522	82	3Y RS 57713	86	ADCC 3111	116	ADFC 2232H	118
1+ SU RS 72222	104	2T2 17223	146	2Y RS 5522	83	3Y RS 57722	85	ADCC 3111H	116	ADFC 2331	117
1+ SU RS 72222	105	2T2 17223H	146	2Y RS 5523	82	3Y RS 57722	86	ADCC 3222	116	ADFC 2331H	117
1+ SU RS 72223	104	2T2 18223	146	2Y RS 5523	83	3Y RS 57723	85	ADCC 3222H	116	ADFC 2332	117
1+ SU RS 72223	105	2T2 18223H	146	2Y RS 5713	82	3Y RS 57723	86	ADCC 3333	116	ADFC 2332H	117
1+ SU RS 75213	104	2T4 12723	146	2Y RS 5713	83	21AC 3200	53	ADCC 3333H	116	ADFC 3113	117
1+ SU RS 75222	104	2T4 12723H	146	2Y RS 5722	82	21AC 3203	54	ADCC 3444	116	ADFC 3113H	117
1+ SU RS 75222	105	2T4 17723	146	2Y RS 5722	83	21IN 3201	53	ADCC 3444H	116	ADFC 3131	118
1+ SU RS 75223	104	2T4 17723H	146	2Y RS 5723	82	21IN 3241	53	ADCC 3777	116	ADFC 3131H	118
1+ SU RS 75223	105	2T4 18723	146	2Y RS 5723	83	21IN 3261	53	ADCC 3777H	116	ADFC 3223	117
1X RF7 2022	87	2T4 18723H	146	2Y RS 7713	82	21IN 3271	53	ADCC 3999	116	ADFC 3223H	117
1X RF7 2023	87	2X RF7 2522	90	2Y RS 7713	83	21IN 4201	54	ADCC 3999H	116	ADFC 3232	118
1X RF7 5022	87	2X RF7 2523	90	2Y RS 7722	82	21IN 4241	54	ADCC 2113	117	ADFC 3232H	118
1X RF7 5023	87	2X RF7 5722	90	2Y RS 7722	83	21IN 4261	54	ADCC 2113H	117	ADFC 3331	117
1X RF7 7022	87	2X RF7 5723	90	2Y RS 7723	82	21IN 4271	54	ADCC 2131	118	ADFC 3331H	117
1X RF7 7023	87	2X RF10 2522	90	2Y RS 7723	83	21SO 3201	54	ADCC 2131H	118	ADFC 3332	117
1X RF10 2022	87	2X RF10 2523	90	3X RF7 25722	93	21SO 3241	54	ADCC 2223	117	ADFC 3332H	117
1X RF10 2023	87	2X RF10 5722	90	3X RF7 25723	93	21SO 3251	54	ADCC 2223H	117	ADFC R6 2111	119
1X RF10 5022	87	2X RF10 5723	90	3X RF10 25722	93	21SO 3271	54	ADCC 2272	118	ADFC R6 2111H	119
1X RF10 5023	87	2X RL 2513	91	3X RF10 25723	93	21SO L3202	55	ADCC 2232H	118	ADFC R6 2113	120
1X RF10 7022	87	2X RL 2513	92	3X RL 25713	94	21SO L3214	55	ADCC 2331	117	ADFC R6 2113H	120
1X RF10 7023	87	2X RL 2522	91	3X RL 25713	95	21SO L3242	55	ADCC 2331H	117	ADFC R6 2222	119
1X RL 2013	88	2X RL 2522	92	3X RL 25722	94	21SO L3243	55	ADCC 2332	117	ADFC R6 2222H	119
1X RL 2013	89	2X RL 2523	91	3X RL 25722	95	21SO L3252	55	ADCC 2332H	117	ADFC R6 2223	120
1X RL 2022	88	2X RL 2523	92	3X RL 25723	94	21SO L3253	55	ADCC 3113	117	ADFC R6 2223H	120
1X RL 2022	89	2X RL 5713	91	3X RL 25723	95	21SO L3272	55	ADCC 3113H	117	ADFC R6 2331	120
1X RL 2023	88	2X RL 5713	92	3X RS 25713	94	21SO L3273	55	ADCC 3131	118	ADFC R6 2331H	120
1X RL 2023	89	2X RL 5722	91	3X RS 25713	95	21SO L3314	54	ADCC 3131H	118	ADFC R6 2332	120
1X RL 5013	88	2X RL 5722	92	3X RS 25722	94	21SO L3343	54	ADCC 3223	117	ADFC R6 2332H	120
1X RL 5013	89	2X RL 5723	91	3X RS 25722	95	21SO L3353	54	ADCC 3223H	117	ADFC R6 2333	119
1X RL 5022	88	2X RL 5723	92	3X RS 25723	94	21SO L3373	54	ADCC 3232	118	ADFC R6 2333H	119
1X RL 5022	89	2X RS 2513	91	3X RS 25723	95	21SO L3402	55	ADCC 3232H	118	ADFC R6 2444	119
1X RL 5023	88	2X RS 2513	92	3Y RF7 22522	84	21SO L3404	55	ADCC 3331	117	ADFC R6 2444H	119
1X RL 5023	89	2X RS 2522	91	3Y RF7 22523	84	21SO L3442	55	ADCC 3331H	117	ADFC R6 2777	119
1X RL 7013	88	2X RS 2522	92	3Y RF7 25522	84	21SO L3444	55	ADCC 3332	117	ADFC R6 2777H	119
1X RL 7013	89	2X RS 2523	91	3Y RF7 25523	84	21SO L3452	55	ADCC 3332H	117	ADFC R6 2999	119
1X RL 7022	88	2X RS 2523	92	3Y RF7 25722	84	21SO L3454	55	ADCC R6 2111	119	ADFC R6 2999H	119
1X RL 7022	89	2X RS 5713	91	3Y RF7 25723	84	21SO L3472	55	ADCC R6 2111H	119	ADFC R6 3111	119
1X RL 7023	88	2X RS 5713	92	3Y RF7 55722	84	21SO L3474	55	ADCC R6 2113	120	ADFC R6 3111H	119
1X RL 7023	89	2X RS 5722	91	3Y RF7 55723	84	ACAN T001	122	ADCC R6 2113H	120	ADFC R6 3113	120

ADFC R6 3777	119	ADRT 132223H	28	ADST 132322	25	ADST 431113	24	ADTR 2777	147	ADWL 1303HUS	20
ADFC R6 3777H	119	ADRT 132322	29	ADST 132322H	25	ADST 431113H	24	ADTR 2777H	147	ADWL 1303UK	20
ADFC R6 3999	119	ADRT 132322H	29	ADST 132332	23	ADST 431311	26	ADTR 2999	147	ADWL 1303US	20
ADFC R6 3999H	119	ADRT 132332	28	ADST 132332H	23	ADST 431311H	26	ADTR 2999H	147	ADWL 1304	19
ADFL 1273	10	ADRT 132332H	28	ADST 132333	21	ADST 431331	24	ADTR 3111	147	ADWL 1304AU	20
ADFL 1273AU	10	ADRT 133331	28	ADST 132333H	21	ADST 431331H	24	ADTR 3111H	147	ADWL 1304EU	20
ADFL 1273H	10	ADRT 133331H	28	ADST 221111	21	ADST 431333	22	ADTR 3222	147	ADWL 1304H	19
ADFL 1273HAU	10	ADRT 133332	28	ADST 221111H	21	ADST 431333H	22	ADTR 3222H	147	ADWL 1304HAU	20
ADFL 1273HUK	10	ADRT 133332H	28	ADST 221113	23	ADST 432222	22	ADTR 3333	147	ADWL 1304HEU	20
ADFL 1273HUS	10	ADRT 133333	27	ADST 221113H	23	ADST 432222H	22	ADTR 3333H	147	ADWL 1304HUK	20
ADFL 1273UK	10	ADRT 133333H	27	ADST 221311	25	ADST 432223	24	ADTR 3444	147	ADWL 1304HUS	20
ADFL 1273US	10	ADRT 134444	27	ADST 221311H	25	ADST 432223H	24	ADTR 3444H	147	ADWL 1304UK	20
ADFL 1274	10	ADRT 134444H	27	ADST 221331	23	ADST 432322	26	ADTR 3777	147	ADWL 1304US	20
ADFL 1274AU	10	ADRT 137777	27	ADST 221331H	23	ADST 432322H	26	ADTR 3777H	147	ADWL 1307	19
ADFL 1274H	10	ADRT 137777H	27	ADST 221333	21	ADST 432332	24	ADTR 3999	147	ADWL 1307AU	20
ADFL 1274HAU	10	ADRT 139999	27	ADST 221333H	21	ADST 432332H	24	ADTR 3999H	147	ADWL 1307EU	20
ADFL 1274HUK	10	ADRT 139999H	27	ADST 222222	21	ADST 432333	22	ADTRD 2113	148	ADWL 1307H	19
ADFL 1274HUS	10	ADRT 221111	27	ADST 222222H	21	ADST 432333H	22	ADTRD 2113H	148	ADWL 1307HAU	20
ADFL 1274UK	10	ADRT 221111 H	27	ADST 222223	23	ADST 4213333	22	ADTRD 2131	148	ADWL 1307HEU	20
ADFL 1274US	10	ADRT 221113	28	ADST 222223H	23	ADTA 1272	11	ADTRD 2131H	148	ADWL 1307HUK	20
ADFL 1277	10	ADRT 221113H	28	ADST 222322	25	ADTA 1272AU	11	ADTRD 2223	148	ADWL 1307HUS	20
ADFL 1277AU	10	ADRT 221311	29	ADST 222322H	25	ADTA 1272H	11	ADTRD 2223H	148	ADWL 1307UK	20
ADFL 1277H	10	ADRT 221311H	29	ADST 222332	23	ADTA 1272HAU	11	ADTRD 2232	148	ADWL 1307US	20
ADFL 1277HAU	10	ADRT 221331	28	ADST 222332H	23	ADTA 1272HUK	11	ADTRD 2232H	148	ADWL 1309	19
ADFL 1277HUK	10	ADRT 221331H	28	ADST 222333	21	ADTA 1272HUS	11	ADTRD 2331	148	ADWL 1309AU	20
ADFL 1277HUS	10	ADRT 222222	27	ADST 222333H	21	ADTA 1272UK	11	ADTRD 2331H	148	ADWL 1309EU	20
ADFL 1277UK	10	ADRT 222222H	27	ADST 231111	21	ADTA 1272US	11	ADTRD 2332	148	ADWL 1309H	19
ADFL 1277US	10	ADRT 222223	28	ADST 23111H	21	ADTA 1273	11	ADTRD 2332H	148	ADWL 1309HAU	20
ADFL 1279	10	ADRT 222223H	28	ADST 231113	23	ADTA 1273AU	11	ADTRD 3113	148	ADWL 1309HEU	20
ADFL 1279AU	10	ADRT 222322	29	ADST 231113H	23	ADTA 1273H	11	ADTRD 3113H	148	ADWL 1309HUK	20
ADFL 1279H	10	ADRT 222322H	29	ADST 231311	25	ADTA 1273HAU	11	ADTRD 3131	148	ADWL 1309HUS	20
ADFL 1279HAU	10	ADRT 222332	28	ADST 231311H	25	ADTA 1273HUK	11	ADTRD 3131H	148	ADWL 1309UK	20
ADFL 1279HUK	10	ADRT 222332H	28	ADST 231331	23	ADTA 1273HUS	11	ADTRD 3223	148	ADWL 1309US	20
ADFL 1279HUS	10	ADRT 223331	28	ADST 231331H	23	ADTA 1273UK	11	ADTRD 3223H	148	AFDA 31171	96
ADFL 1279UK	10	ADRT 223331H	28	ADST 231333	21	ADTA 1273US	11	ADTRD 3232	148	AFDA 31172	96
ADFL 1279US	10	ADRT 223332	28	ADST 231333H	21	ADTA 1274	11	ADTRD 3232H	148	AFDA 31173	96
ADFL 1303	10	ADRT 223332H	28	ADST 232222	21	ADTA 1274AU	11	ADTRD 3331	148	AFDA 31174	96
ADFL 1303AU	10	ADRT 223333	27	ADST 232222H	21	ADTA 1274H	11	ADTRD 3331H	148	AFDA 31177	96
ADFL 1303H	10	ADRT 223333H	27	ADST 232223	23	ADTA 1274HAU	11	ADTRD 3332	148	AFDA 31179	96
ADFL 1303HAU	10	ADRT 224444	27	ADST 232223H	23	ADTA 1274HUK	11	ADTRD 3332H	148	AFDA 31191	96
ADFL 1303HUK	10	ADRT 224444H	27	ADST 232322	25	ADTA 1274HUS	11	ADTW 2111	147	AFDA 31192	96
ADFL 1303HUS	10	ADRT 227777	27	ADST 232322H	25	ADTA 1274UK	11	ADTW 2111H	147	AFDA 31193	96
ADFL 1303UK	10	ADRT 227777H	27	ADST 232332	23	ADTA 1274US	11	ADTW 2333	147	AFDA 31194	96
ADFL 1303US	10	ADRT 229999	27	ADST 232332H	23	ADTA 1277	11	ADTW 2333H	147	AFDA 31197	96
ADFL 1304	10	ADRT 229999H	27	ADST 232333	21	ADTA 1277AU	11	ADTW 3111	147	AFDA 31199	96
ADFL 1304AU	10	ADRT 231111	27	ADST 232333H	21	ADTA 1277H	11	ADTW 3111H	147	AFDA 31271	96
ADFL 1304H	10	ADRT 231111H	27	ADST 321111	22	ADTA 1277HAU	11	ADTW 3333	147	AFDA 31272	96
ADFL 1304HAU	10	ADRT 231113	28	ADST 321111H	22	ADTA 1277HUK	11	ADTW 3333H	147	AFDA 31273	96
ADFL 1304HUK	10	ADRT 231113H	28	ADST 321113	24	ADTA 1277HUS	11	ADTWD 2113	148	AFDA 31274	96
ADFL 1304HUS	10	ADRT 231311	29	ADST 321113H	24	ADTA 1277UK	11	ADTWD 2113H	148	AFDA 31277	96
ADFL 1304UK	10	ADRT 231311H	29	ADST 321311	26	ADTA 1277US	11	ADTWD 2131	148	AFDA 31279	96
ADFL 1304US	10	ADRT 231331	28	ADST 321311H	26	ADTA 1279	11	ADTWD 2131H	148	AFDA 31291	96
ADFL 1307	10	ADRT 231331H	28	ADST 321331	24	ADTA 1279AU	11	ADTWD 2331	148	AFDA 31292	96
ADFL 1307AU	10	ADRT 232222	27	ADST 321331H	24	ADTA 1279H	11	ADTWD 2331H	148	AFDA 31293	96
ADFL 1307H	10	ADRT 232222H	27	ADST 321333	22	ADTA 1279HAU	11	ADTWD 3113	148	AFDA 31294	96
ADFL 1307HAU	10	ADRT 232223	28	ADST 321333H	22	ADTA 1279HUK	11	ADTWD 3113H	148	AFDA 31297	96
ADFL 1307HUK	10	ADRT 232223H	28	ADST 322222	22	ADTA 1279HUS	11	ADTWD 3131	148	AFDA 31299	96
ADFL 1307HUS	10	ADRT 232322	29	ADST 322222H	22	ADTA 1279UK	11	ADTWD 3131H	148	AFDA 52171	97
ADFL 1307UK	10	ADRT 232322H	29	ADST 322223	24	ADTA 1279US	11	ADTWD 3331	148	AFDA 52172	97
ADFL 1307US	10	ADRT 232332	28	ADST 322223H	24	ADTA 1302	11	ADTWD 3331H	148	AFDA 52173	97
ADFL 1309	10	ADRT 232332H	28	ADST 322322	26	ADTA 1302AU	11	ADWL 1273	19	AFDA 52174	97
ADFL 1309AU	10	ADRT 233331	28	ADST 322322H	26	ADTA 1302H	11	ADWL 1273AU	20	AFDA 52177	97
ADFL 1309H	10	ADRT 233331H	28	ADST 322332	24	ADTA 1302HAU	11	ADWL 1273EU	20	AFDA 52179	97
ADFL 1309HAU	10	ADRT 233332	28	ADST 322332H	24	ADTA 1302HUK	11	ADWL 1273H	19	AFDA 52191	97
ADFL 1309HUK	10	ADRT 233332H	28	ADST 322333	22	ADTA 1302HUS	11	ADWL 1273HAU	20	AFDA 52192	97
ADFL 1309HUS	10	ADRT 233333	27	ADST 322333H	22	ADTA 1302UK	11	ADWL 1273HEU	20	AFDA 52193	97
ADFL 1309UK	10	ADRT 233333H	27	ADST 331111	22	ADTA 1302US	11	ADWL 1273HUK	20	AFDA 52194	97
ADFL 1309US	10	ADRT 234444	27	ADST 331111H	22	ADTA 1303	11	ADWL 1273HUS	20	AFDA 52197	97
ADRT 121111	27	ADRT 234444H	27	ADST 331113	24	ADTA 1303AU	11	ADWL 1273UK	20	AFDA 52199	97
ADRT 121111H	27	ADRT 237777	27	ADST 331113H	24	ADTA 1303H	11	ADWL 1273US	20	AFDA 52271	97
ADRT 121113	28	ADRT 237777H	27	ADST 331311	26	ADTA 1303HAU	11	ADWL 1274	19	AFDA 52272	97
ADRT 121113H	28	ADRT 239999	27	ADST 331311H	26	ADTA 1303HUK	11	ADWL 1274AU	20	AFDA 52273	97
ADRT 121311	29	ADRT 239999H	27	ADST 331331	24	ADTA 1303HUS	11	ADWL 1274EU	20	AFDA 52274	97
ADRT 121311H	29	ADST 121111	21	ADST 331331H	24	ADTA 1303UK	11	ADWL 1274H	19	AFDA 52277	97
ADRT 121331	28	ADST 121111H	21	ADST 331333	22	ADTA 1303US	11	ADWL 1274HAU	20	AFDA 52279	97
ADRT 121331H	28	ADST 121113	23	ADST 331333H	22	ADTA 1304	11	ADWL 1274HEU	20	AFDA 52291	97
ADRT 122222	27	ADST 121113H	23	ADST 332222	22	ADTA 1304AU	11	ADWL 1274HUK	20	AFDA 52292	97
ADRT 122222H	27	ADST 121311	25	ADST 332222H	22	ADTA 1304H	11	ADWL 1274HUS	20	AFDA 52293	97
ADRT 122223	28	ADST 121311H	25	ADST 332223	24	ADTA 1304HAU	11	ADWL 1274UK	20	AFDA 52294	97
ADRT 122223H	28	ADST 121331	23	ADST 332223H	24	ADTA 1304HUK	11	ADWL 1274US	20	AFDA 52297	97
ADRT 122322	29	ADST 121331H	23	ADST 332322	26	ADTA 1304HUS	11	ADWL 1277	19	AFDA 52299	97
ADRT 122322H	29	ADST 121333	21	ADST 332322H	26	ADTA 1304UK	11	ADWL 1277AU	20	AFLC 31171	96
ADRT 122332	28	ADST 121333H	21	ADST 332332	24	ADTA 1304US	11	ADWL 1277EU	20	AFLC 31172	96
ADRT 122332H	28	ADST 122222	21	ADST 332332H	24	ADTA 1307	11	ADWL 1277H	19	AFLC 31173	96
ADRT 123331	28	ADST 122222H	21	ADST 332333	22	ADTA 1307AU	11	ADWL 1277HAU	20	AFLC 31174	96
ADRT 123331H	28	ADST 122223	23	ADST 332333H	22	ADTA 1307H	11	ADWL 1277HEU	20	AFLC 31177	96
ADRT 123332	28	ADST 122223H	23	ADST 421111	22	ADTA 1307HAU	11	ADWL 1277HUK	20	AFLC 31179	96
ADRT 123332H	28	ADST 122322	25	ADST 421111H	22	ADTA 1307HUK	11	ADWL 1277HUS	20	AFLC 31191	96
ADRT 123333	27	ADST 122322H	25	ADST 421113	24	ADTA 1307HUS	11	ADWL 1277UK	20	AFLC 31192	96
ADRT 123333H	27	ADST 122332	23	ADST 421113H	24	ADTA 1307UK	11	ADWL 1277US	20	AFLC 31193	96
ADRT 124444	27	ADST 122332H	23	ADST 421311	26	ADTA 1307US	11	ADWL 1279	19	AFLC 31194	96
ADRT 124444H	27	ADST 122333	21	ADST 421311H	26	ADTA 1309	11	ADWL 1279AU	20	AFLC 31197	96
ADRT 127777	27	ADST 122333H	21	ADST 421331	24	ADTA 1309AU	11	ADWL 1279EU	20	AFLC 31199	96
ADRT 127777H	27	ADST 131111	21	ADST 421331H	24	ADTA 1309H	11	ADWL 1279H	19	AFLC 31271	96
ADRT 129999	27	ADST 131111H	21	ADST 421333H	22	ADTA 1309HAU	11				



















AFLC 52173	97	ALLC 52112	98	ARRI 0121	134	ATWS 1271	36	AUDEX 1301	138	AUSF 1307H	72
AFLC 52174	97	ALLC 52113	98	ARRI 0122	134	ATWS 1272	36	AUDEX 1301	162	AUSF 1309	72
AFLC 52177	97	ALLC 52114	98	ARRI 0129	134	ATWS 1273	36	AUDEX 1302	138	AUSF 1309H	72
AFLC 52179	97	ALLC 52117	98	ARRI 0221	134	ATWS 1274	36	AUDEX 1302	162	AUTR 1722	151
AFLC 52191	97	ALLC 52119	98	ARRI 0222	134	ATWS 1277	36	AUDEX 1303	138	AUTR 1733	151
AFLC 52192	97	ALLC 52211	98	ARRI 0229	134	ATWS 1279	36	AUDEX 1304	138	AUTR 1744	151
AFLC 52193	97	ALLC 52212	98	ARRI 1121	135	ATWS 1301	36	AUDEX 1307	138	AUTR 1777	151
AFLC 52194	97	ALLC 52213	98	ARRI 1122	135	ATWS 1302	36	AUDEX 1309	138	AUTR 1799	151
AFLC 52197	97	ALLC 52214	98	ARRI 1129	135	ATWS 1303	36	AUDY 1271	121	AUTW 1711	151
AFLC 52199	97	ALLC 52217	98	ARRI 1221	135	ATWS 1304	36	AUDY 1271H	121	AUTW 1722	151
AFLC 52271	97	ALLC 52219	98	ARRI 1222	135	ATWS 1307	36	AUDY 1272	121	AUTW 1733	151
AFLC 52272	97	ALPU 31111	98	ARRI 1229	135	ATWS 1309	36	AUDY 1272H	121	AWBI 21111	30
AFLC 52273	97	ALPU 31112	98	ARRI 2121	132	ATWS 1313	36	AUDY 1273	121	AWBI 21111H	30
AFLC 52274	97	ALPU 31113	98	ARRI 2122	132	ATWS 1323	36	AUDY 1273H	121	AWBI 21113	31
AFLC 52277	97	ALPU 31114	98	ARRI 2129	132	ATWS 1331	36	AUDY 1274	121	AWBI 21113H	31
AFLC 52279	97	ALPU 31117	98	ARRI 2221	132	ATWS 1332	36	AUDY 1274H	121	AWBI 21311	32
AFLC 52291	97	ALPU 31119	98	ARRI 2222	132	ATWS 1334	36	AUDY 1277	121	AWBI 21311H	32
AFLC 52292	97	ALPU 31211	98	ARRI 2229	132	ATWS 1337	36	AUDY 1277H	121	AWBI 21331	31
AFLC 52293	97	ALPU 31212	98	ARRI 7121	133	ATWS 1343	36	AUDY 1279	121	AWBI 21331H	31
AFLC 52294	97	ALPU 31213	98	ARRI 7122	133	ATWS 1373	36	AUDY 1279H	121	AWBI 22222	30
AFLC 52297	97	ALPU 31214	98	ARRI 7129	133	ATWS 1773	36	AUDY 1301	121	AWBI 22222H	30
AFLC 52299	97	ALPU 31217	98	ARRI 7221	133	AUAN T001	122	AUDY 1301H	121	AWBI 22223	31
AFPU 31171	96	ALPU 31219	98	ARRI 7222	133	AUAN T002	122	AUDY 1302	121	AWBI 22223H	31
AFPU 31172	96	ALPU 52111	98	ARRI 7229	133	AUAN T003	122	AUDY 1302H	121	AWBI 22322	32
AFPU 31173	96	ALPU 52112	98	ARUP 2111	61	AUAN T004	122	AUDY 1303	121	AWBI 22322H	32
AFPU 31174	96	ALPU 52113	98	ARUP 2112	61	AUAN T007	122	AUDY 1303H	121	AWBI 22332	31
AFPU 31177	96	ALPU 52114	98	ARUP 2119	61	AUAN T009	122	AUDY 1304	121	AWBI 22332H	31
AFPU 31179	96	ALPU 52117	98	ARUP 2121	61	AUCA 1211	74	AUDY 1304H	121	AWBI 23331	31
AFPU 31191	96	ALPU 52119	98	ARUP 2122	61	AUCA 1211H	74	AUDY 1307	121	AWBI 23331H	31
AFPU 31192	96	ALPU 52211	98	ARUP 2129	61	AUCA 1222	74	AUDY 1307H	121	AWBI 23332	31
AFPU 31193	96	ALPU 52212	98	ARUP 2211	61	AUCA 1222H	74	AUDY 1309	121	AWBI 23332H	31
AFPU 31194	96	ALPU 52213	98	ARUP 2212	61	AUCA 1232	74	AUDY 1309H	121	AWBI 23333	30
AFPU 31197	96	ALPU 52214	98	ARUP 2219	61	AUCA 1232H	74	AUIN L001	122	AWBI 23333H	30
AFPU 31199	96	ALPU 52217	98	ARUP 2221	61	AUCA 1242	74	AUIN L002	122	AWBI 24444	30
AFPU 31271	96	ALPU 52219	98	ARUP 2222	61	AUCA 1242H	74	AUIN L003	122	AWBI 24444H	30
AFPU 31272	96	ARIN 0111	134	ARUP 2229	61	AUCA 1272	74	AUIN L004	122	AWBI 27777	30
AFPU 31273	96	ARIN 0112	134	ARUP 7111	61	AUCA 1272H	74	AUIN L007	122	AWBI 27777H	30
AFPU 31274	96	ARIN 0119	134	ARUP 7112	61	AUCA 1292	74	AUIN L009	122	AWBI 29999	30
AFPU 31277	96	ARIN 0121	134	ARUP 7119	61	AUCA 1292H	74	AUSBD 1211	73	AWBI 29999H	30
AFPU 31279	96	ARIN 0122	134	ARUP 7121	61	AUCA 1311	74	AUSBD 1211H	73	AWBI 31111	30
AFPU 31291	96	ARIN 0129	134	ARUP 7122	61	AUCA 1311H	74	AUSBD 1212	73	AWBI 31111H	30
AFPU 31292	96	ARIN 0191	134	ARUP 7129	61	AUCA 1322	74	AUSBD 1212H	73	AWBI 31113	31
AFPU 31293	96	ARIN 0192	134	ARUP 7211	61	AUCA 1322H	74	AUSBD 1213	73	AWBI 31113H	31
AFPU 31294	96	ARIN 0199	134	ARUP 7212	61	AUCA 1332	74	AUSBD 1213H	73	AWBI 31311	32
AFPU 31297	96	ARIN 0211	134	ARUP 7219	61	AUCA 1332H	74	AUSBD 1214	73	AWBI 31311H	32
AFPU 31299	96	ARIN 0212	134	ARUP 7221	61	AUCA 1342	74	AUSBD 1214H	73	AWBI 31331	31
AFPU 52171	97	ARIN 0219	134	ARUP 7222	61	AUCA 1342H	74	AUSBD 1217	73	AWBI 31331H	31
AFPU 52172	97	ARIN 0221	134	ARUP 7229	61	AUCA 1372	74	AUSBD 1217H	73	AWBI 32222	30
AFPU 52173	97	ARIN 0222	134	ARUP L0111	61	AUCA 1372H	74	AUSBD 1219	73	AWBI 32222H	30
AFPU 52174	97	ARIN 0229	134	ARUP L0112	61	AUCA 1392	74	AUSBD 1219H	73	AWBI 32223	31
AFPU 52177	97	ARIN 0291	134	ARUP L0119	61	AUCA 1392H	74	AUSBD 1311	73	AWBI 32223H	31
AFPU 52179	97	ARIN 0292	134	ARUP L0121	61	AUCBD 1211	75	AUSBD 1311H	73	AWBI 32322	32
AFPU 52191	97	ARIN 0299	134	ARUP L0122	61	AUCBD 1211H	75	AUSBD 1312	73	AWBI 32322H	32
AFPU 52192	97	ARIN 1111	135	ARUP L0129	61	AUCBD 1212	75	AUSBD 1312H	73	AWBI 32332	31
AFPU 52193	97	ARIN 1112	135	ARUP L0211	61	AUCBD 1212H	75	AUSBD 1313	73	AWBI 32332H	31
AFPU 52194	97	ARIN 1119	135	ARUP L0212	61	AUCBD 1213	75	AUSBD 1313H	73	AWBI 33331	31
AFPU 52197	97	ARIN 1121	135	ARUP L0219	61	AUCBD 1213H	75	AUSBD 1314	73	AWBI 33331H	31
AFPU 52199	97	ARIN 1122	135	ARUP L0221	61	AUCBD 1214	75	AUSBD 1314H	73	AWBI 33332	31
AFPU 52271	97	ARIN 1129	135	ARUP L0222	61	AUCBD 1214H	75	AUSBD 1317	73	AWBI 33332H	31
AFPU 52272	97	ARIN 1191	135	ARUP L0229	61	AUCBD 1217	75	AUSBD 1317H	73	AWBI 33333	30
AFPU 52273	97	ARIN 1192	135	ARUP L1111	61	AUCBD 1217H	75	AUSBD 1319	73	AWBI 33333H	30
AFPU 52274	97	ARIN 1199	135	ARUP L1112	61	AUCBD 1219	75	AUSBD 1319H	73	AWBI 34444	30
AFPU 52277	97	ARIN 1211	135	ARUP L1119	61	AUCBD 1219H	75	AUSC 1201	72	AWBI 34444H	30
AFPU 52279	97	ARIN 1212	135	ARUP L1121	61	AUCBD 1311	75	AUSC 1201H	72	AWBI 37777	30
AFPU 52291	97	ARIN 1219	135	ARUP L1122	61	AUCBD 1311H	75	AUSC 1202	72	AWBI 37777H	30
AFPU 52292	97	ARIN 1221	135	ARUP L1129	61	AUCBD 1312	75	AUSC 1202H	72	AWBI 39999	30
AFPU 52293	97	ARIN 1222	135	ARUP L1211	61	AUCBD 1312H	75	AUSC 1203	72	AWBI 39999H	30
AFPU 52294	97	ARIN 1229	135	ARUP L1212	61	AUCBD 1313	75	AUSC 1203H	72	AWBU 21111	32
AFPU 52297	97	ARIN 1291	135	ARUP L1219	61	AUCBD 1313H	75	AUSC 1204	72	AWBU 21111H	32
AFPU 52299	97	ARIN 1292	135	ARUP L1221	61	AUCBD 1314	75	AUSC 1204H	72	AWBU 21113	33
ALDA 31111	98	ARIN 1299	135	ARUP L1222	61	AUCBD 1314H	75	AUSC 1207	72	AWBU 21113H	33
ALDA 31112	98	ARIN 2111	132	ARUP L1229	61	AUCBD 1317	75	AUSC 1207H	72	AWBU 21311	33
ALDA 31113	98	ARIN 2112	132	ATWD 2213	37	AUCBD 1317H	75	AUSC 1209	72	AWBU 21311H	33
ALDA 31114	98	ARIN 2119	132	ATWD 2223	37	AUCBD 1319	75	AUSC 1209H	72	AWBU 21331	33
ALDA 31117	98	ARIN 2121	132	ATWD 2231	37	AUCBD 1319H	75	AUSC 1301	72	AWBU 21331H	33
ALDA 31119	98	ARIN 2122	132	ATWD 2232	37	AUCC 1211	74	AUSC 1301H	72	AWBU 22222	32
ALDA 31211	98	ARIN 2129	132	ATWD 2234	37	AUCC 1211H	74	AUSC 1302	72	AWBU 22222H	32
ALDA 31212	98	ARIN 2191	132	ATWD 2237	37	AUCC 1222	74	AUSC 1302H	72	AWBU 22223	33
ALDA 31213	98	ARIN 2192	132	ATWD 2243	37	AUCC 1222H	74	AUSC 1303	72	AWBU 22223H	33
ALDA 31214	98	ARIN 2199	132	ATWD 2271	37	AUCC 1232	74	AUSC 1303H	72	AWBU 22322	33
ALDA 31217	98	ARIN 2211	132	ATWD 2272	37	AUCC 1232H	74	AUSC 1304	72	AWBU 22322H	33
ALDA 31219	98	ARIN 2212	132	ATWD 2273	37	AUCC 1242	74	AUSC 1304H	72	AWBU 22332	33
ALDA 52111	98	ARIN 2219	132	ATWD 2274	37	AUCC 1242H	74	AUSC 1307	72	AWBU 22332H	33
ALDA 52112	98	ARIN 2221	132	ATWD 2277	37	AUCC 1272	74	AUSC 1307H	72	AWBU 23331	33
ALDA 52113	98	ARIN 2222	132	ATWD 2279	37	AUCC 1272H	74	AUSC 1309	72	AWBU 23331H	33
ALDA 52114	98	ARIN 2229	132	ATWD 2301	37	AUCC 1292	74	AUSC 1309H	72	AWBU 23332	33
ALDA 52117	98	ARIN 2291	132	ATWD 2302	37	AUCC 1292H	74	AUSF 1201	72	AWBU 23332H	33
ALDA 52119	98	ARIN 2292	132	ATWD 2303	37	AUCC 1311	74	AUSF 1201H	72	AWBU 23333	32
ALDA 52211	98	ARIN 2299	132	ATWD 2304	37	AUCC 1311H	74	AUSF 1202	72	AWBU 23333H	32
ALDA 52212	98	ARIN 7111	133	ATWD 2307	37	AUCC 1322	74	AUSF 1202H	72	AWBU 24444	32
ALDA 52213	98	ARIN 7112	133	ATWD 2309	37	AUCC 1322H	74	AUSF 1203	72	AWBU 24444H	32
ALDA 52214	98	ARIN 7119	133	ATWD 2313	37	AUCC 1332	74	AUSF 1203H	72	AWBU 27777	32
ALDA 52217	98	ARIN 7121	133	ATWD 2323	37	AUCC 1332H	74	AUSF 1204	72	AWBU 27777H	32
ALDA 52219	98	ARIN 7122	133	ATWD 2331	37	AUCC 1342	74	AUSF 1204H	72	AWBU 29999	32
ALLC 31111	98	ARIN 7129	133	ATWD 2332	37	AUCC 1342H	74	AUSF 1207	72	AWBU 29999H	32
ALLC 31112	98	ARIN 7191	133	ATWD 2334	37	AUCC 1372	74	AUSF 1207H	72	AWBU 31111	32
ALLC 31113	98	ARIN 7192	133	ATWD 2337	37	AUCC 1372H	74	AUSF 1209	72	AWBU 31111H	32
ALLC 31114	98	ARIN 7199	133	ATWD 2343	37	AUCC 1392	74	AUSF 1209H	72	AWBU 31113	33
ALLC 31117	98	ARIN 7211	133	ATWD 2373	37	AUCC 1392H	74	AUSF 1301	72	AWBU 31113H	33
ALLC 31119	98	ARIN 7212	133	ATWD 2773	37	AUDEX 1271	138	AUSF 130			

AWBU 32322	33	AYUP 2223	35	BIINC 1690	123	CODE 9001	51	HEC+ 0213	45	HECE 0023	45
AWBU 32322H	33	AYUP 2223H	35	BIINC 1698	123	CODE 9002	52	HEC+ 0222	45	HECE 0112	45
AWBU 32332	33	AYUP 2231	35	BIINF 1610	123	CODE 9005	52	HEC+ 0223	45	HECE 0113	45
AWBU 32332H	33	AYUP 2231H	35	BIINF 1618	123	CODE 9105	51	HEC+ 0512	45	HECE 0122	45
AWBU 33331	33	AYUP 2232	35	BIINF 1620	123	CODE 9207	52	HEC+ 0513	45	HECE 0123	45
AWBU 33331H	33	AYUP 2232H	35	BIINF 1628	123	CODE 9555	53	HEC+ 0522	45	HECE 0212	45
AWBU 33332	33	AYUP 2233	34	BIINF 1670	123	CODE 9605	51	HEC+ 0523	45	HECE 0213	45
AWBU 33332H	33	AYUP 2233H	34	BIINF 1678	123	CODE 9666	53	HEC+ L012	46	HECE 0222	45
AWBU 33333	32	AYUP 2244	34	BIINF 1680	123	CODE L1005	52	HEC+ L013	46	HECE 0223	45
AWBU 33333H	32	AYUP 2244H	34	BIINF 1688	123	CODE L1006	142	HEC+ L022	46	HECE 0512	45
AWBU 34444	32	AYUP 2277	34	BIINF 1690	123	CODE L1006	166	HEC+ L023	46	HECE 0513	45
AWBU 34444H	32	AYUP 2277H	34	BIINF 1698	123	CODE L2005	52	HEC+ L112	46	HECE 0522	45
AWBU 37777	32	AYUP 2299	34	BIUP 1610	50	CODE L2006	142	HEC+ L113	46	HECE 0523	45
AWBU 37777H	32	AYUP 2299H	34	BIUP 1618	50	CODE L2006	166	HEC+ L122	46	HEC- L012	46
AWBU 39999	32	AYUP 3111	34	BIUP 1620	50	CODE L3005	52	HEC+ L123	46	HEC- L013	46
AWBU 39999H	32	AYUP 3111H	34	BIUP 1628	50	CODE L7005	52	HEC+ L212	46	HEC- L022	46
AYTR 2702	149	AYUP 3113	35	BIUP 1670	50	CODE L7006	142	HEC+ L213	46	HEC- L023	46
AYTR 2702H	149	AYUP 3113H	35	BIUP 1678	50	CODE L7006	166	HEC+ L222	46	HEC- L112	46
AYTR 2703	149	AYUP 3122	34	BIUP 1680	50	CODE L9005	52	HEC+ L223	46	HEC- L113	46
AYTR 2703H	149	AYUP 3122H	34	BIUP 1688	50	COEX 1001	141	HEC+ L512	46	HEC- L122	46
AYTR 2704	149	AYUP 3123	35	BIUP 1690	50	COEX 1001	165	HEC+ L513	46	HEC- L123	46
AYTR 2704H	149	AYUP 3123H	35	BIUP 1698	50	COEX 1002	141	HEC+ L522	46	HEC- L212	46
AYTR 2707	149	AYUP 3131	35	BOEX 1600	140	COEX 1002	165	HEC+ L523	46	HEC- L213	46
AYTR 2707H	149	AYUP 3131H	35	BOEX 1600	164	COEX 1111	143	HEC- 0012	45	HEC- L222	46
AYTR 2709	149	AYUP 3132	35	BOEX 1602	140	COEX 1111	167	HEC- 0013	45	HEC- L223	46
AYTR 2709H	149	AYUP 3132H	35	BOEX 1602	164	COEX 1151	141	HEC- 0022	45	HEC- L512	46
AYTR 2902	150	AYUP 3133	34	BOEX 1608	140	COEX 1151	165	HEC- 0023	45	HEC- L513	46
AYTR 2902H	150	AYUP 3133H	34	BOEX 1608	164	COEX 1211	143	HEC90 0012	45	HEC- L522	46
AYTR 2903	150	AYUP 3144	34	BOEX 1680	140	COEX 1211	167	HEC90 0013	45	HEC- L523	46
AYTR 2903H	150	AYUP 3144H	34	BOEX 1680	164	COEX 1251	142	HEC90 0022	45	HECT 0012	45
AYTR 2904	150	AYUP 3177	34	BOIN 1600	124	COEX 1251	166	HEC90 0023	45	HECT 0013	45
AYTR 2904H	150	AYUP 3177H	34	BOIN 1602	124	COEX 2001	141	HEC90 0112	45	HECT 0022	45
AYTR 2907	150	AYUP 3199	34	BOIN 1608	124	COEX 2001	165	HEC90 0113	45	HECT 0023	45
AYTR 2907H	150	AYUP 3199H	34	BOIN 1680	124	COEX 2002	141	HEC90 0122	45	HECT 0112	45
AYTR 2909	150	AYUP 3211	34	BOWW 1001	50	COEX 2002	165	HEC90 0123	45	HECT 0113	45
AYTR 2909H	150	AYUP 3211H	34	BOWW 1002	50	COEX 2111	143	HEC90 0212	45	HECT 0122	45
AYTR 3702	149	AYUP 3213	35	BOWW 1003	50	COEX 2111	167	HEC90 0213	45	HECT 0123	45
AYTR 3702H	149	AYUP 3213H	35	BOWW 1009	50	COEX 2151	141	HEC90 0222	45	HECT 0212	45
AYTR 3703	149	AYUP 3222	34	BOWW 1101	50	COEX 2151	165	HEC90 0223	45	HECT 0213	45
AYTR 3703H	149	AYUP 3222H	34	BOWW 1102	50	COEX 2211	143	HEC90 0512	45	HECT 0222	45
AYTR 3704	149	AYUP 3223	35	BOWW 1103	50	COEX 2211	167	HEC90 0513	45	HECT 0223	45
AYTR 3704H	149	AYUP 3223H	35	BOWW 1109	50	COEX 2251	142	HEC90 0522	45	HECT 0512	45
AYTR 3707	149	AYUP 3231	35	BOWW 5201	13	COEX 2251	166	HEC90 0523	45	HECT 0513	45
AYTR 3707H	149	AYUP 3231H	35	BOWW 5202	13	COEX 3001	141	HEC90 L012	46	HECT 0522	45
AYTR 3709	149	AYUP 3232	35	BOWW 5203	13	COEX 3001	165	HEC90 L013	46	HECT 0523	45
AYTR 3709H	149	AYUP 3232H	35	BOWW 5209	13	COEX 3002	141	HEC90 L022	46	HECT L012	46
AYTR 3902	150	AYUP 3233	34	BOWW 6010	124	COEX 3002	165	HEC90 L023	46	HECT L013	46
AYTR 3902H	150	AYUP 3233H	34	BOWW 6012	124	COEX 7111	143	HEC90 L112	46	HECT L022	46
AYTR 3903	150	AYUP 3244	34	BUEX 1610	139	COEX 7111	167	HEC90 L113	46	HECT L023	46
AYTR 3903H	150	AYUP 3244H	34	BUEX 1610	163	COEX 7151	141	HEC90 L122	46	HECT L112	46
AYTR 3904	150	AYUP 3277	34	BUEX 1618	139	COEX 7151	165	HEC90 L123	46	HECT L113	46
AYTR 3904H	150	AYUP 3277H	34	BUEX 1618	163	COEX 7211	143	HEC90 L212	46	HECT L122	46
AYTR 3907	150	AYUP 3299	34	BUEX 1620	139	COEX 7211	167	HEC90 L213	46	HECT L123	46
AYTR 3907H	150	AYUP 3299H	34	BUEX 1620	163	COEX 7251	142	HEC90 L222	46	HECT L212	46
AYTR 3909	150	BEWW 6010	140	BUEX 1628	139	COEX 7251	166	HEC90 L223	46	HECT L213	46
AYTR 3909H	150	BEWW 6010	164	BUEX 1628	163	COGU 0051	127	HEC90 L512	46	HECT L222	46
AYTW 2701	149	BEWW 6012	140	BUEX 1670	139	COGU 0052	127	HEC90 L513	46	HECT L223	46
AYTW 2701H	149	BEWW 6012	164	BUEX 1670	163	COGU 0054	128	HEC90 L522	46	HECT L512	46
AYTW 2702	149	BIEXC 1610	139	BUEX 1678	139	CONC 0007	132	HEC90 L523	46	HECT L513	46
AYTW 2702H	149	BIEXC 1610	163	BUEX 1678	163	CONC 0051	129	HEC- 0112	45	HECT L522	46
AYTW 2703	149	BIEXC 1618	139	BUEX 1680	139	CONC 0052	130	HEC- 0113	45	HECT L523	46
AYTW 2703H	149	BIEXC 1618	163	BUEX 1680	163	CONC 0054	131	HEC120 0012	45	HECX 0012	45
AYTW 2901	150	BIEXC 1620	139	BUEX 1688	139	CONC 0070	133	HEC120 0013	45	HECX 0013	45
AYTW 2901H	150	BIEXC 1620	163	BUEX 1688	163	CONC 0110	134	HEC120 0022	45	HECX 0022	45
AYTW 2902	150	BIEXC 1628	139	BUEX 1690	139	CONC 0111	135	HEC120 0023	45	HECX 0023	45
AYTW2902H	150	BIEXC 1628	163	BUEX 1690	163	ELEM 1212	39	HEC120 0112	45	HECX 0112	45
AYTW 2903	150	BIEXC 1670	139	BUEX 1698	139	ELEM 1222	39	HEC120 0113	45	HECX 0113	45
AYTW 2903H	150	BIEXC 1670	163	BUEX 1698	163	ELEM 1313	39	HEC120 0122	45	HECX 0122	45
AYTW 3701	149	BIEXC 1678	139	CODE 1001	51	ELEM 1323	39	HEC120 0123	45	HECX 0123	45
AYTW 3701H	149	BIEXC 1678	163	CODE 1002	52	ELEM 2212	39	HEC120 0212	45	HECX 0212	45
AYTW 3702	149	BIEXC 1680	139	CODE 1005	52	ELEM 2222	39	HEC120 0213	45	HECX 0213	45
AYTW 3702H	149	BIEXC 1680	163	CODE 1006	142	ELEM 2313	39	HEC120 0222	45	HECX 0222	45
AYTW 3703	149	BIEXC 1688	139	CODE 1006	166	ELEM 2323	39	HEC120 0223	45	HECX 0223	45
AYTW 3703H	149	BIEXC 1688	163	CODE 1105	51	ELEM 3212	40	HEC120 0512	45	HECX 0512	45
AYTW 3901	150	BIEXC 1690	139	CODE 1207	52	ELEM 3222	40	HEC120 0513	45	HECX 0513	45
AYTW 3901H	150	BIEXC 1690	163	CODE 1555	53	ELEM 3313	40	HEC120 0522	45	HECX 0522	45
AYTW 3902	150	BIEXC 1698	139	CODE 1605	51	ELEM 3323	40	HEC120 0523	45	HECX 0523	45
AYTW 3902H	150	BIEXC 1698	163	CODE 1666	53	ELEM 4212	40	HEC120 L012	46	HECX L012	46
AYTW 3903	150	BIEXF 1610	139	CODE 2001	51	ELEM 4222	40	HEC120 L013	46	HECX L013	46
AYTW 3903H	150	BIEXF 1610	163	CODE 2002	52	ELEM 4313	40	HEC120 L022	46	HECX L022	46
AYUP 2111	34	BIEXF 1618	139	CODE 2005	52	ELEM 4323	40	HEC120 L023	46	HECX L023	46
AYUP 2111H	34	BIEXF 1618	163	CODE 2006	142	ELEM 5212	41	HEC120 L112	46	HECX L112	46
AYUP 2113	35	BIEXF 1620	139	CODE 2006	166	ELEM 5222	41	HEC120 L113	46	HECX L113	46
AYUP 2113H	35	BIEXF 1620	163	CODE 2105	51	ELEM 5313	41	HEC120 L122	46	HECX L122	46
AYUP 2122	34	BIEXF 1628	139	CODE 2207	52	ELEM 5323	41	HEC120 L123	46	HECX L123	46
AYUP 2122H	34	BIEXF 1628	163	CODE 2405	51	ELEM 6212	41	HEC120 L212	46	HECX L212	46
AYUP 2123	35	BIEXF 1670	139	CODE 2555	53	ELEM 6222	41	HEC120 L213	46	HECX L213	46
AYUP 2123H	35	BIEXF 1670	163	CODE 2666	53	ELEM 6313	41	HEC120 L222	46	HECX L222	46
AYUP 2131	35	BIEXF 1678	139	CODE 3001	51	ELEM 6323	41	HEC120 L223	46	HECX L223	46
AYUP 2131H	35	BIEXF 1678	163	CODE 3002	52	ELEM 7212	42	HEC120 L512	46	HECX L512	46
AYUP 2132	35	BIEXF 1680	139	CODE 3005	52	ELEM 7222	42	HEC120 L513	46	HECX L513	46
AYUP 2132H	35	BIEXF 1680	163	CODE 3105	51	ELEM 7313	42	HEC120 L522	46	HECX L522	46
AYUP 2133	34	BIEXF 1688	139	CODE 3207	52	ELEM 7323	42	HEC120 L523	46	HECX L523	46
AYUP 2133H	34	BIEXF 1688	163	CODE 3555	53	ELEM 8212	42	HEC- 0122	45	HECY 0012	45
AYUP 2144	34	BIEXF 1690	139	CODE 3605	51	ELEM 8222	42	HEC- 0123	45	HECY 0013	45
AYUP 2144H	34	BIEXF 1690	163	CODE 3666	53	ELEM 8313	42	HEC- 0212	45	HECY 0022	45
AYUP 2177	34	BIEXF 1698	139	CODE 7001	51	ELEM 8323	42	HEC- 0213	45	HECY 0023	45
AYUP 2177H	34	BIEXF 1698	163	CODE 7002	52	HEC+ 0012	45	HEC- 0222	45	HECY 0112	45
AYUP 2199	34	BIINC 1610	123	CODE 7005	52	HEC+ 0013	45	HEC- 0223	45	HECY 0113	45
AYUP 2199H	34	BIINC 1618	123	CODE 7006	142	HEC+ 0022	45	HEC- 0512	45	HECY 0122	45
AYUP 2211	34	BIINC 1620									

HECY 0513	45	HVCBD 3312	100	HVWA 1001AU	48	MIGU 4121	128	MUGU 1112	59	PIIN 4102	126
HECY 0522	45	HVCBD 3313	100	HVWA 1001UK	48	MIGU 4122	128	MUGU 1119	59	PIIN 4111	126
HECY 0523	45	HVCBD 3314	100	HVWA 1001US	48	MIGU 4129	128	MUGU 1121	59	PIIN 7101	126
HECY L012	46	HVCBD 3317	100	HVWA 1002	48	MIGU 4191	128	MUGU 1122	59	PIIN 7102	126
HECY L013	46	HVCBD 3319	100	HVWA 1002AU	48	MIGU 4192	128	MUGU 1129	59	PIIN 7111	126
HECY L022	46	HVCBD 3321	100	HVWA 1002UK	48	MIGU 4199	128	MUGU 1211	59	PIIN 9101	126
HECY L023	46	HVCBD 3322	100	HVWA 1002US	48	MIGU 4211	128	MUGU 1212	59	PIIN 9102	126
HECY L112	46	HVCBD 3323	100	HVWA 1003	48	MIGU 4212	128	MUGU 1219	59	PIIN 9111	126
HECY L113	46	HVCBD 3324	100	HVWA 1003AU	48	MIGU 4219	128	MUGU 1221	59	PIUP L1050	57
HECY L122	46	HVCBD 3327	100	HVWA 1003UK	48	MIGU 4221	128	MUGU 1222	59	PIUP L1150	57
HECY L123	46	HVCBD 3329	100	HVWA 1003US	48	MIGU 4222	128	MUGU 1229	59	PIUP L1152	58
HECY L212	46	HVCC 3011	100	HVWA 1004	48	MIGU 4229	128	MUGU 2111	59	PIUP L1154	58
HECY L213	46	HVCC 3012	100	HVWA 1004AU	48	MIGU 4291	128	MUGU 2112	59	PIUP L1156	58
HECY L222	46	HVCC 3013	100	HVWA 1004UK	48	MIGU 4292	128	MUGU 2119	59	PIUP L2050	57
HECY L223	46	HVCC 3014	100	HVWA 1004US	48	MIGU 4299	128	MUGU 2121	59	PIUP L2150	57
HECY L512	46	HVCC 3017	100	HVWA 1007	48	MIP1 1115	125	MUGU 2122	59	PIUP L2152	58
HECY L513	46	HVCC 3019	100	HVWA 1007AU	48	MIP1 1125	125	MUGU 2129	59	PIUP L2154	58
HECY L522	46	HVCC 3021	100	HVWA 1007UK	48	MIP1 1225	125	MUGU 2211	59	PIUP L2156	58
HECY L523	46	HVCC 3022	100	HVWA 1007US	48	MIP1 1235	125	MUGU 2212	59	PIUP L3050	57
HEL+ 0002	44	HVCC 3023	100	HVWA 1009	48	MIP1 1725	125	MUGU 2219	59	PIUP L3150	57
HEL+ 0003	44	HVCC 3024	100	HVWA 1009AU	48	MIP1 1775	125	MUGU 2221	59	PIUP L3152	58
HEL+ L002	44	HVCC 3027	100	HVWA 1009UK	48	MIP1 1925	125	MUGU 2222	59	PIUP L3154	58
HEL+ L003	44	HVCC 3029	100	HVWA 1009US	48	MIP1 1995	125	MUGU 2229	59	PIUP L3156	58
HEL- 0002	44	HVFL 1001	12	HVWB 1001	48	MIP1 2117	125	MUGU 4111	59	PIUP L7050	57
HEL- 0003	44	HVFL 1001AU	12	HVWB 1002	48	MIP1 2227	125	MUGU 4112	59	PIUP L7150	57
HEL90 0002	44	HVFL 1001UK	12	HVWB 1003	48	MIP1 2777	125	MUGU 4119	59	PIUP L7152	58
HEL90 0003	44	HVFL 1001US	12	HVWB 1004	48	MIP1 2997	125	MUGU 4121	59	PIUP L7154	58
HEL90 L002	44	HVFL 1002	12	HVWB 1007	48	MIP1 4711	152	MUGU 4122	59	PIUP L7156	58
HEL90 L003	44	HVFL 1002AU	12	HVWB 1009	48	MIP1 4712	152	MUGU 4129	59	PIUP L9050	57
HEL120 0002	44	HVFL 1002UK	12	HVWT 100149	49	MIP1 4721	153	MUGU 4211	59	PIUP L9150	57
HEL120 0003	44	HVFL 1002US	12	HVWT 1001AU	49	MIP1 4722	153	MUGU 4212	59	PIUP L9152	58
HEL120 L002	44	HVFL 1003	12	HVWT 1001EU	49	MIPRU 1115	56	MUGU 4219	59	PLAS 0007	132
HEL120 L003	44	HVFL 1003AU	12	HVWT 1001UK	49	MIPRU 1225	56	MUGU 4221	59	PLAS 0051	129
HELE 0002	44	HVFL 1003UK	12	HVWT 1001US	49	MIPRU 1775	56	MUGU 4222	59	PLAS 0052	130
HELE 0003	44	HVFL 1003US	12	HVWT 1002	49	MIPRU 1995	56	MUGU 4229	59	PLAS 0054	131
HELE L002	44	HVFL 1004	12	HVWT 1002AU	49	MIPU 1115	56	MUWW 1111	60	PLAS 0070	133
HELE L003	44	HVFL 1004AU	12	HVWT 1002EU	49	MIPU 1225	56	MUWW 1112	60	PLAS 0110	134
HEL- L002	44	HVFL 1004UK	12	HVWT 1002UK	49	MIPU 1525	56	MUWW 1121	60	PLAS 0111	135
HEL- L003	44	HVFL 1004US	12	HVWT 1002US	49	MIPU 1575	56	MUWW 1122	60	SCAR 2850	13
HEL9 2002	43	HVFL 1007	12	HVWT 1003	49	MIPU 1595	56	MUWW 1211	60	SCAR 2851	13
HEL9 2003	43	HVFL 1007AU	12	HVWT 1003AU	49	MIPU 1615	56	MUWW 1212	60	SCAR 2852	13
HEL9 5002	43	HVFL 1007UK	12	HVWT 1003EU	49	MIPU 1775	56	MUWW 1221	60	SCAR 2853	13
HEL9 5003	43	HVFL 1007US	12	HVWT 1003UK	49	MIPU 1995	56	MUWW 1222	60	SCAR 2857	13
HEL9 7002	43	HVFL 1009	12	HVWT 1003US	49	MIPU 2115	56	MUWW 1511	60	SCAR 4011	64
HEL9 7003	43	HVFL 1009AU	12	HVWT 1004	49	MIPU 2225	56	MUWW 1512	60	SCAR 4031	64
HEL9 0022	43	HVFL 1009UK	12	HVWT 1004AU	49	MIPU 2775	56	MUWW 1521	60	SCAR 4035	64
HEL9 0023	43	HVFL 1009US	12	HVWT 1004EU	49	MIPU 2995	56	MUWW 1522	60	SCAR 4035EU	65
HEL9 0024	43	HVSD 1111	99	HVWT 1004UK	49	MIPU 3115	56	MUWW 1611	60	SCAR 4061	64
HEL9 0025	43	HVSD 1112	99	HVWT 1004US	49	MIPU 3225	56	MUWW 1612	60	SCAR 4065	64
HEL9 0032	43	HVSD 1113	99	HVWT 1007	49	MIPU 3315	56	MUWW 1621	60	SCAR 4065EU	65
HEL9 0033	43	HVSD 1114	99	HVWT 1007AU	49	MIPU 3325	56	MUWW 1622	60	SCAR 4075	64
HEL9 0034	43	HVSD 1117	99	HVWT 1007EU	49	MIPU 3375	56	MUWW 2111	60	SCAR 4075EU	65
HEL9 0035	43	HVSD 1119	99	HVWT 1007UK	49	MIPU 3395	56	MUWW 2111P	60	SCAR 4201	62
HEL9 0522	43	HVSC 1001	99	HVWT 1007US	49	MIPU 3775	56	MUWW 2112	60	SCAR 4201D	62
HEL9 0523	43	HVSC 1002	99	HVWT 1009	49	MIPU 3995	56	MUWW 2112P	60	SCAR 4201P	62
HEL9 0524	43	HVSC 1003	99	HVWT 1009AU	49	MIPW 4711	152	MUWW 2121	60	SCAR 4231	62
HEL9 0525	43	HVSC 1004	99	HVWT 1009EU	49	MIPW 4721	153	MUWW 2121P	60	SCAR 4231D	62
HEL9 0532	43	HVSC 1007	99	HVWT 1009UK	49	MIPW 1111	129	MUWW 2122	60	SCAR 4231P	62
HEL9 0533	43	HVSC 1009	99	HVWT 1009US	49	MIPW 1112	129	MUWW 2122P	60	SCAR 4251	62
HEL9 0534	43	HVSU 1001	99	ITRO 1101	106	MIPW 1121	129	MUWW 2211	60	SCAR 4251D	62
HEL9 0535	43	HVSU 1002	99	ITRO 1102	106	MIPW 1122	129	MUWW 2211P	60	SCAR 4251P	62
HEL9 0922	43	HVSU 1003	99	ITRO 1111	106	MIPW 1191	129	MUWW 2212	60	SCAR 4271	62
HEL9 0923	43	HVSU 1004	99	ITRO 1122	106	MIPW 1192	129	MUWW 2212P	60	SCAR 4271D	62
HEL9 0932	43	HVSU 1007	99	ITRO 2201	106	MIPW 1211	129	MUWW 2221	60	SCAR 4271P	62
HEL9 0933	43	HVSU 1009	99	ITRO 2202	106	MIPW 1212	129	MUWW 2221P	60	SCAR 4281	62
HEL9 1022	43	HVSU 4772	151	ITRO 2211	106	MIPW 1221	129	MUWW 2222	60	SCAR 4281D	62
HEL9 1023	43	HVSU 4773	151	ITRO 2222	106	MIPW 1222	129	MUWW 2222P	60	SCAR 4281P	62
HEL9 1024	43	HVSU 4774	151	MIGU 1111	127	MIPW 1291	129	MUWW 4111	60	SCAR 4311	64
HEL9 1025	43	HVSU 4777	151	MIGU 1112	127	MIPW 1292	129	MUWW 4111P	60	SCAR 4331	64
HEL9 1032	43	HVSU 4779	151	MIGU 1119	127	MIPW 2111	130	MUWW 4112	60	SCAR 4335	64
HEL9 1033	43	HVSU 4792	152	MIGU 1121	127	MIPW 2112	130	MUWW 4112P	60	SCAR 4335EU	65
HEL9 1034	43	HVSU 4793	152	MIGU 1122	127	MIPW 2121	130	MUWW 4121	60	SCAR 4361	64
HEL9 1035	43	HVSU 4794	152	MIGU 1129	127	MIPW 2122	130	MUWW 4121P	60	SCAR 4365	64
HEL9 2022	43	HVSU 4797	152	MIGU 1191	127	MIPW 2191	130	MUWW 4122	60	SCAR 4365EU	65
HEL9 2023	43	HVSU 4799	152	MIGU 1192	127	MIPW 2192	130	MUWW 4122P	60	SCAR 4375	64
HEL9 2024	43	HVSW 4771	151	MIGU 1199	127	MIPW 2211	130	MUWW 4211	60	SCAR 4375EU	65
HEL9 2025	43	HVSW 4772	151	MIGU 1211	127	MIPW 2212	130	MUWW 4211P	60	SCAR 4401	62
HEL9 2032	43	HVSW 4773	151	MIGU 1212	127	MIPW 2221	130	MUWW 4212	60	SCAR 4401D	62
HEL9 2033	43	HVSW 4791	152	MIGU 1219	127	MIPW 2222	130	MUWW 4212P	60	SCAR 4401P	62
HEL9 2034	43	HVSW 4792	152	MIGU 1221	127	MIPW 2291	130	MUWW 4221	60	SCAR 4431	62
HEL9 2035	43	HVSW 4793	152	MIGU 1222	127	MIPW 2292	130	MUWW 4221P	60	SCAR 4431D	62
HELT 0002	44	HVTA 1001	12	MIGU 1229	127	MIPW 4111	131	MUWW 4222	60	SCAR 4431P	62
HELT 0003	44	HVTA 1001AU	12	MIGU 1291	127	MIPW 4112	131	MUWW 4222P	60	SCAR 4451	62
HELT L002	44	HVTA 1001UK	12	MIGU 1292	127	MIPW 4121	131	NAGA 1111	57	SCAR 4451D	62
HELT L003	44	HVTA 1001US	12	MIGU 1299	127	MIPW 4122	131	NAGA 1112	57	SCAR 4451P	62
HELX 0002	44	HVTA 1002	12	MIGU 2111	127	MIPW 4191	131	NAGA 1116	57	SCAR 4471	62
HELX 0003	44	HVTA 1002AU	12	MIGU 2112	127	MIPW 4192	131	NAGA 1117	57	SCAR 4471D	62
HELX L002	44	HVTA 1002UK	12	MIGU 2119	127	MIPW 4211	131	NAGA 2111	57	SCAR 4471P	62
HELX L003	44	HVTA 1002US	12	MIGU 2121	127	MIPW 4212	131	NAGA 2112	57	SCAR 4481	62
HELY 0002	44	HVTA 1003	12	MIGU 2122	127	MIPW 4221	131	NAGA 2116	57	SCAR 4481D	62
HELY 0003	44	HVTA 1003AU	12	MIGU 2129	127	MIPW 4222	131	NAGA 2117	57	SCAR 4481P	62
HELY L002	44	HVTA 1003UK	12	MIGU 2191	127	MIPW 4291	131	NAGA 7111	57	SCAR 4511	64
HELY L003	44	HVTA 1003US	12	MIGU 2192	127	MIPW 4292	131	NAGA 7112	57	SCAR 4531	64
HVCA 3011	100	HVTA 1004	12	MIGU 2199	127	MRWW 1101	129	NAGA 7116	57	SCAR 4535	64
HVCA 3012	100	HVTA 1004AU	12	MIGU 2211	127	MRWW 1102	129	NAGA 7117	57	SCAR 4535EU	65
HVCA 3013	100	HVTA 1004UK	12	MIGU 2212	127	MRWW 1201	129	NTRO 1000	107	SCAR 4561	64
HVCA 3014	100	HVTA 1004US	12	MIGU 2219	127	MRWW 1202	129	NTRO 1111	107	SCAR 4565	64
HVCA 3017	100	HVTA 1007	12	MIGU 2221	127	MRWW 2101	130	NTRO 2000	107	SCAR 4565EU	65
HVCA 3019	100	HVTA 1007AU	12	MIGU 2222	127	MRWW 2102	130	NTRO 2222	107	SCAR 4575	64
HVCA 3021	100	HVTA 1007UK	12	MIGU 2229	127	MRWW 2201	130	PIIN 1101	126	SCAR 4575EU	65
HVCA 3022	100	HVTA 1007US	12	MIGU 2291	127	MRWW 2202	130	PIIN 1102	126	SCAR 4701	62
HVCA 3023											

SCAR 4735EU	65	SCAR 8231D	63	SIPR 2107	68	TH3N 28223	113	TPCM 2001	154
SCAR 4761	64	SCAR 8231P	63	SIPR 2111	68	TH3N 28223H	113	TPCM 2002	154
SCAR 4765	64	SCAR 8251	63	SIPR 2112	68	THC 12223	16	TPCO 1001	154
SCAR 4765EU	65	SCAR 8251D	63	SIPR 2117	68	THC 12223H	16	TPCO 1001	158
SCAR 4771	62	SCAR 8251P	63	SIPR 2121	68	THC 17223	16	TPCO 1002	154
SCAR 4771D	62	SCAR 8271	63	SIPR 2122	68	THC 17223H	16	TPCO 1002	158
SCAR 4771P	62	SCAR 8271D	63	SIPR 2127	68	THC 18223	16	TPCO 2001	154
SCAR 4775	64	SCAR 8271P	63	SIPR 2131	69	THC 18223H	16	TPCO 2002	154
SCAR 4775EU	65	SCAR 8281	63	SIPR 2132	69	THC 22223	16	TPEC 1801	155
SCAR 4781	62	SCAR 8281D	63	SIPR 2137	69	THC 22223H	16	TPEC 1802	155
SCAR 4781D	62	SCAR 8281P	63	SIPR 2141	69	THC 27223	16	TPEF 0001	156
SCAR 4781P	62	SCAR 8411	63	SIPR 2142	69	THC 27223H	16	TPEF 0002	156
SCAR 4811	64	SCAR 8411D	63	SIPR 2147	69	THC 28223	16	TPEF 0002	158
SCAR 4831	64	SCAR 8411P	63	SIPR 2601	68	THC 28223H	16	TPEP 2001	156
SCAR 4835	64	SCAR 8431	63	SIPR 2602	68	THF AU 12H	9	TPEP 2002	156
SCAR 4835EU	65	SCAR 8431D	63	SIPR 2607	68	THF AU 17H	9	TPMC 1801	155
SCAR 4861	64	SCAR 8431P	63	SIPR 2611	68	THF AU 18H	9	TPMC 1802	155
SCAR 4865	64	SCAR 8451	63	SIPR 2612	68	THF AU 22H	9	TPOP 2001	156
SCAR 4865EU	65	SCAR 8451D	63	SIPR 2617	68	THF AU 27H	9	TPOP 2002	156
SCAR 4875	64	SCAR 8451P	63	SIPR 2621	68	THF AU 28H	9	TPPL 1001	156
SCAR 4875EU	65	SCAR 8471	63	SIPR 2622	68	THF EU 12H	9	TPPL 1001	159
SCAR 6711	62	SCAR 8471D	63	SIPR 2627	68	THF EU 17H	9	TPPL 1002	156
SCAR 6711D	62	SCAR 8471P	63	SIPR 2631	69	THF EU 18H	9	TPPL 1002	159
SCAR 6711P	62	SCAR 8481	63	SIPR 2632	69	THF EU 22H	9	TPPR 1001	157
SCAR 6731	62	SCAR 8481D	63	SIPR 2637	69	THF EU 27H	9	TPPR 1001	159
SCAR 6731D	62	SCAR 8481P	63	SIPR 2641	69	THF EU 28H	9	TPPR 1002	157
SCAR 6731P	62	SCAR 8711	63	SIPR 2642	69	THF UK 12H	9	TPPR 1002	159
SCAR 7201	62	SCAR 8711D	63	SIPR 2647	69	THF UK 17H	9	TPREC 1802	158
SCAR 7201D	62	SCAR 8711P	63	SISU 1601	108	THF UK 18H	9	TPREP 0002	159
SCAR 7201P	62	SCAR 8731	63	SISU 1602	108	THF UK 22H	9	TPRI 1002	158
SCAR 7211	63	SCAR 8731D	63	SISU 1607	108	THF UK 27H	9	TPRI 2002	158
SCAR 7211P	63	SCAR 8731P	63	SISU 2101	108	THF UK 28H	9	TW3N 12223	114
SCAR 7231	62	SCAR 8751	63	SISU 2102	108	THF US 12H	9	TW3N 12223H	114
SCAR 7231D	62	SCAR 8751D	63	SISU 2107	108	THF US 17H	9	TW3N 17223	114
SCAR 7231P	62	SCAR 8751P	63	SISU 2111	108	THF US 18H	9	TW3N 17223H	114
SCAR 7241	63	SCAR 8771	63	SISU 2112	108	THF US 22H	9	TW3N 18223	114
SCAR 7241P	63	SCAR 8771D	63	SISU 2117	108	THF US 27H	9	TW3N 18223H	114
SCAR 7251	62	SCAR 8771P	63	SISU 2121	108	THF US 28H	9	TWIN 12223	114
SCAR 7251D	62	SCAR 8781	63	SISU 2122	108	THH 22223	18	TWIN 12223H	114
SCAR 7251P	62	SCAR 8781D	63	SISU 2127	108	THH 22223H	18	TWIN 17223	114
SCAR 7252	63	SCAR 8781P	63	SISU 2131	109	THH 27223	18	TWIN 17223H	114
SCAR 7252P	63	SCAR 9211	64	SISU 2132	109	THH 27223H	18	TWIN 18223	114
SCAR 7261	63	SCAR 9211P	64	SISU 2137	109	THH 28223	18	TWIN 18223H	114
SCAR 7261P	63	SCAR 9231	64	SISU 2141	109	THH 28223H	18		
SCAR 7271	62	SCAR 9231P	64	SISU 2142	109	THIN 12223	112		
SCAR 7271D	62	SCAR 9251	64	SISU 2147	109	THIN 12223H	112		
SCAR 7271P	62	SCAR 9251P	64	SISU 2601	108	THIN 17223	112		
SCAR 7281	62	SCAR 9271	64	SISU 2602	108	THIN 17223H	112		
SCAR 7281D	62	SCAR 9271P	64	SISU 2607	108	THIN 18223	112		
SCAR 7281P	62	SCAR 9281	64	SISU 2611	108	THIN 18223H	112		
SCAR 7291	63	SCAR 9281P	64	SISU 2612	108	THIN 22223	113		
SCAR 7291P	63	SCAR 9411	64	SISU 2617	108	THIN 22223H	113		
SCAR 7401	62	SCAR 9411P	64	SISU 2621	108	THIN 27223	113		
SCAR 7401D	62	SCAR 9431	64	SISU 2622	108	THIN 27223H	113		
SCAR 7401P	62	SCAR 9431P	64	SISU 2627	108	THIN 28223	113		
SCAR 7411	63	SCAR 9451	64	SISU 2631	109	THIN 28223H	113		
SCAR 7411P	63	SCAR 9451P	64	SISU 2632	109	THP 22223	16		
SCAR 7431	62	SCAR 9471	64	SISU 2637	109	THP 22223H	16		
SCAR 7431D	62	SCAR 9471P	64	SISU 2641	109	THP 27223	16		
SCAR 7431P	62	SCAR 9481	64	SISU 2642	109	THP 27223H	16		
SCAR 7441	63	SCAR 9481P	64	SISU 2647	109	THP 28223	16		
SCAR 7441P	63	SCAR 9711	64	STEP 1001	138	THP 28223H	16		
SCAR 7451	62	SCAR 9711P	64	STEP 1001	162	THR 22223	18		
SCAR 7451D	62	SCAR 9731	64	STEP 1001H	138	THR 22223H	18		
SCAR 7451P	62	SCAR 9731P	64	STEP 1002	138	THR 27223	18		
SCAR 7452	63	SCAR 9751	64	STEP 1002	162	THR 27223H	18		
SCAR 7452P	63	SCAR 9751P	64	STEP 1002H	138	THR 28223	18		
SCAR 7461	63	SCAR 9771	64	STEP 1007	138	THR 28223H	18		
SCAR 7461P	63	SCAR 9771P	64	STEP 1007	162	THW 12223	17		
SCAR 7471	62	SCAR 9781	64	STEP 1007H	138	THW 12223H	17		
SCAR 7471D	62	SCAR 9781P	64	STEP 1008	138	THW 17223	17		
SCAR 7471P	62	SCLI 3501	66	STEP 1008	162	THW 17223H	17		
SCAR 7481	62	SCLI 3501EU	67	STEP 1008H	138	THW 18223	17		
SCAR 7481D	62	SCLI 3502	66	STEP 1009	138	THW 18223H	17		
SCAR 7481P	62	SCLI 3502EU	67	STEP 1009	162	THWP AU 12	17		
SCAR 7491	63	SCLI 3507	66	STEP 1009H	138	THWP AU 12H	17		
SCAR 7491P	63	SCLI 3507EU	67	STIN 1001	115	THWP AU 17	17		
SCAR 7701	62	SCLI 5001	66	STIN 1001H	115	THWP AU 17H	17		
SCAR 7701D	62	SCLI 5001EU	67	STIN 1002	115	THWP AU 18	17		
SCAR 7701P	62	SCLI 5002	66	STIN 1002H	115	THWP AU 18H	17		
SCAR 7711	63	SCLI 5002EU	67	STIN 1007	115	THWP EU 12	17		
SCAR 7711P	63	SCLI 5007	66	STIN 1007H	115	THWP EU 12H	17		
SCAR 7731	62	SCLI 5007EU	67	STIN 1008	115	THWP EU 17	17		
SCAR 7731D	62	SCLI 7501	66	STIN 1008H	115	THWP EU 17H	17		
SCAR 7731P	62	SCLI 7501P	66	STIN 1009	115	THWP EU 18	17		
SCAR 7741	63	SCLI 7531	65	STIN 1009H	115	THWP EU 18H	17		
SCAR 7741P	63	SCLI 7531D	65	STUP 1001	18	THWP UK 12	17		
SCAR 7751	62	SCLI 7531P	65	STUP 1001H	18	THWP UK 12H	17		
SCAR 7751D	62	SCLI 7561	66	STUP 1002	18	THWP UK 17	17		
SCAR 7751P	62	SCLI 7561P	66	STUP 1002H	18	THWP UK 17H	17		
SCAR 7752	63	SCLI 7571	65	STUP 1007	18	THWP UK 18	17		
SCAR 7752P	63	SCLI 7571D	65	STUP 1007H	18	THWP UK 18H	17		
SCAR 7761	63	SCLI 7571P	65	STUP 1008	18	THWP US 12	17		
SCAR 7761P	63	SCLI 7581	65	STUP 1008H	18	THWP US 12H	17		
SCAR 7771	62	SCLI 7581D	65	STUP 1009	18	THWP US 17	17		
SCAR 7771D	62	SCLI 7581P	65	STUP 1009H	18	THWP US 17H	17		
SCAR 7771P	62	SCLI 7591	66	TH3N 12223	112	THWP US 18	17		
SCAR 7781	62	SCLI 7591P	66	TH3N 12223H	112	THWP US 18H	17		
SCAR 7781D	62	SCLIU 5001	67	TH3N 17223	112	TPBA 1000	154		
SCAR 7781P	62	SCLIU 5002	67	TH3N 17223H	112	TPBA 2000	154		
SCAR 7791	63	SCLIU 5007	67	TH3N 18223	112	TPCE 0901	155		
SCAR 7791P	63	SIPR 1601	68	TH3N 18223H	112	TPCE 0902	155		
SCAR 8211	63	SIPR 1602	68	TH3N 22223	113	TPCI 0901	155		
SCAR 8211D	63	SIPR 1607	68	TH3N 22223H	113	TPCI 0902	155		
SCAR 8211P	63	SIPR 2101	68	TH3N 27223	113	TPCM 1001	154		
SCAR 8231	63	SIPR 2102	68	TH3N 27223H	113	TPCM 1002	154		

## GLOSSARY

	ENGLISH	FRANÇAIS	NEDERLANDS	DEUTSCH
	CE standard	norme CE	CE norm	CE Standard
	fixture class 1	appareil classe 1	toestel klasse 1	Gerät Klasse 1
	fixture class 2	appareil classe 2	toestel klasse 2	Gerät Klasse 2
	fixture class 3	appareil classe 3	toestel klasse 3	Gerät Klasse 3
<b>IP</b>	protection level	indice de protection	beschermingsindicatie	Schutzklasse
	beam	rayon de lumière	lichtbundel	lichtbündel
	upper beam	rayon de lumière supérieur	bovenste lichtbundel	lichtbündel oben
	lower beam	rayon de lumière inférieur	onderste lichtbundel	lichtbündel unter
	left beam	rayon de lumière à gauche	linker lichtbundel	lichtbündel links
	right beam	rayon de lumière à droite	rechter lichtbundel	lichtbündel rechts
	ecologic (LED)	écologique (LED)	ecologisch (LED)	ökologisch (LED)
<b>+B</b>	with base	avec base	met basis	mit Sockel
<b>D+B</b>	driver with base	convertisseur avec base	voeding met basis	Konverter mit Sockel
	1 lighting side	1 face lumineuse	1 zijde verlicht	1 Seite Beleuchtung
	2 lighting sides	2 faces lumineuses	2 zijden verlicht	2 Seiten Beleuchtung
	adjustable	orientable	richtbaar	Schwenkbar
<b>mm</b>	dimensions in mm.	dimensions en mm.	afmetingen in mm.	Abmessungen in mm.
<b>W/C</b>	wall or ceiling	applique ou plafonnier	wand of plafond	Wand oder Decke
<b>L</b>	length	longueur	lengte	Länge
<b>W</b>	width	largeur	breedte	Breite
<b>H</b>	height	hauteur	hoogte	Höhe
	non-dimmable	non dimmable	niet-dimbaar	nicht dimmbar
	1-10V dimmable	1-10V dimmable	1-10V dimbaar	1-10V dimmbar
	PUSH-DIM dimmable	PUSH-DIM dimmable	PUSH-DIM dimbaar	PUSH-DIM dimmbar
	Dali dimmable	Dali dimmable	Dali dimbaar	Dali dimmbar
	TRIAC/IGBT dimmable	TRIAC/IGBT dimmable	TRIAC/IGBT dimbaar	TRIAC/IGBT dimmbar
	IGBT dimmable	IGBT dimmable	IGBT dimbaar	IGBT dimmbar
<b>RS 16</b>	short rod 160mm	tige courte 160mm	korte stang 160mm	kurze Stange 160mm
<b>RL 79</b>	long rod 790mm	tige longue 790mm	lange stang 790mm	lange Stange 790mm
<b>RF 75</b>	fixed rod 750 mm	tige fixe 750 mm	vaste stang 750 mm	feste Stange 750 mm
<b>RF 100</b>	fixed rod 1000 mm	tige fixe 1000 mm	vaste stang 1000 mm	feste Stange 1000 mm

**Trizo21** | Kerrebroek 52 | B-9850 Deinze | Belgium

T +32 (0)9 380 43 43

E [info@trizo21.com](mailto:info@trizo21.com)

W [www.trizo21.com](http://www.trizo21.com)

W [www.elements-configurator.trizo21.com](http://www.elements-configurator.trizo21.com)

 [instagram.com/trizo21](https://www.instagram.com/trizo21)

 [facebook.com/trizo21](https://www.facebook.com/trizo21)

All models | Copyright © Trizo21 & Bruno Van Meenen

All products | Handmade in Belgium

Pricelist | 03.2023

**retail prices in euro, VAT excl.**

**Important notice:**

**For warranty use only Trizo21® supplied LED drivers as mentioned.**

**No warranty when used without the supplied LED drivers!**

All information in this pricelist is without engagement, replaces all preceding information and can always be modified.

Trizo21 bvba has the right to change the technical aspects of its products at any time without prior notice.

All our product carry the CE logo. The CE logo represents an implicit quality assurance.

For further technical information, please visit [www.trizo21.com](http://www.trizo21.com)

All products are supplied without bulbs and/or drivers, unless stated otherwise.

All dimensions are expressed in mm.

No part of this book may be reproduced without written authorisation of Trizo21 bvba.





