

CARPYEN
BARCELONA

2023

TARIFA DE PRECIOS
PRICE LIST

PVP PRECIO RECOMENDADO SIN IVA
RECOMMENDED RETAIL PRICE WITHOUT VAT

Alle Preise zzgl. ges. MwSt.

ÍNDICE INTERACTIVO / INTERACTIVE INDEX

Pulse en el nombre del producto para ir a su página / Click on the product name to go to its page

A	Aitana	3	N	Neil	29, 30
	Alabast	4		Nirvana	31
B	Boop!	4		Nura	32
	Boop! IP55	5	O	Oliver	33
	Boop! XL	5	P	Parme	33
C	Capsule	6		Pedra	33
	Carla	6		Pippet	34
	Còdol	7		Punt	35
	Colette	7, 8	Q	Quadrat	35
E	El Cubo	8	R	Rebound	36
	Equilibrium	9		Robin	37
G	Gala	9, 10		Robinson	37
	Galilea	10	S	Sasha	38
	Garçon	10, 11		Sasha_battery	38
	Greta	11, 12, 13		Sky	39
H	Harry	13		Snaik	39
	Harry plus	13		Sputnik	39
	Hotel-python	14	T	Tema	40
I	Isamu	14, 15, 16		Tiffany 2	40
J	Jerry	16, 17		Totora	41
	Jerry-hotel	18		Triana 1	42
K	Kelly	18, 19		Triana Accessories	42, 43
L	Lineal	20, 21		Triana 2	43
	Lineal biblo	21		Triana Canopy	44
M	Macao	22		Tripod	45
	Magnetic	22		Twist	45
	Mandarina	23	V	Venus	46
	Margot	23	Y	Yoko	46
	Mei	24, 24, 26	Z	Zoom	47
	Mei Móvil	27		Canopy A	48
	Melina	28		Canopy B	49
	Montoya	28		Bombillas / Bulbs	50

MODELO COD. ACABADOS FINISHES EUROS

Aitana

LAMPARA DE PIE / FLOOR LAMP

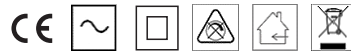
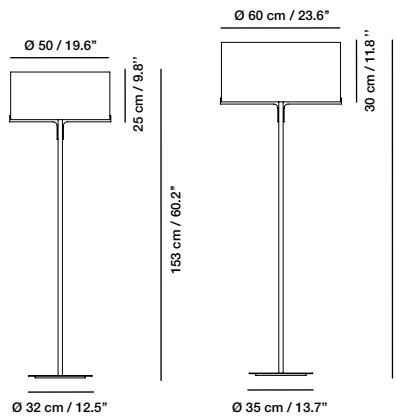

Estructura: metal
Pantalla: algodón

Structure: metal
Shade: cotton

1541011 Ø 50 cm / 19.7"
Níquel mate + Pantalla blanca
1541200 Negro + Pantalla Blanca

Ø 50 cm / 19.7"
Matt nickel + White shade
Black + White shade

680,00
500,00

1531011 Ø 60 cm / 23.6"
Níquel mate + Pantalla blanca
1531200 Negro + Pantalla Blanca

Ø 60 cm / 23.6"
Matt nickel + White shade
Black + White shade

655,00
585,00

Otros colores de pantalla consultar
Equipada con tirador

Other shade colours upon request
Equipped with pull switch

Sin bombilla
2 x E27 LED
30 W / 220-240 V / 50-60 Hz

Without bulb
2 x E27 LED
30 W / 220-240 V / 50-60 Hz



Aitana

SOBREMESA / TABLE LAMP

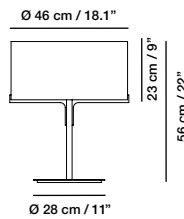

Estructura: metal
Pantalla: algodón

Structure: metal
Shade: cotton

1551011 Níquel mate + Pantalla blanca
1551200 Negro + Pantalla Blanca

Matt nickel + White shade
Black + White shade

480,00
440,00

Otros colores de pantalla consultar
Equipada con tirador

Other shade colours upon request
Equipped with pull switch

Sin bombilla
2 x E27 LED
30 W / 220-240 V / 50-60 Hz

Without bulb
2 x E27 LED
30 W / 220-240 V / 50-60 Hz



Aitana

COLGANTE / SUSPENSION LAMP

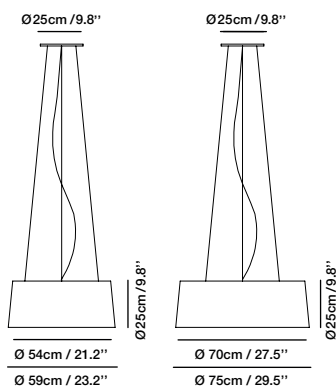

Estructura: metal
Pantalla: algodón

Structure: metal
Shade: cotton

1521011 Ø 59 cm / 23.2"
Níquel mate + Pantalla blanca
1521200 Negro + Pantalla Blanca

Ø 59 cm / 23.2"
Matt nickel + White shade
Black + White shade

480,00
460,00

1511011 Ø 75 cm / 29.5"
Níquel mate + Pantalla blanca
1511200 Negro + Pantalla Blanca

Ø 75 cm / 29.5"
Matt nickel + White shade
Black + White shade

565,00
530,00

Otros colores de pantalla consultar
Equipada con cable eléctrico
2 m (78.7")

Other shade colours upon request
Equipped with 2 m (78.7") of
electric cable

Sin bombilla
2 x E27 LED
25 W / 220-240 V / 50-60 Hz

Without bulb
2 x E27 LED
25 W / 220-240 V / 50-60 Hz





MODELO

COD.

ACABADOS

FINISHES

EUROS

Alabast

SOBREMESA / TABLE LAMP

IN / OUTDOOR



CON CABLE / WITH CABLE

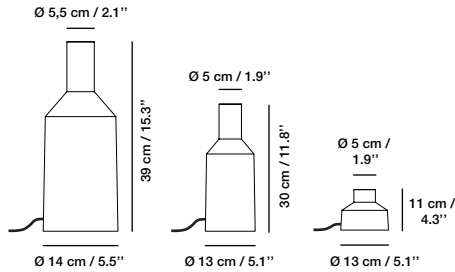

5141225
5131225
5121225

Estructura: Alabastro*
Cable de lino
Interior
h39 cm / 15.3"
h30 cm / 11.8"
h11 cm / 4.3"

Structure: Alabaster*
Linen cable
Interior
h39 cm / 15.3"
h30 cm / 11.8"
h11 cm / 4.3"

374,00
349,00
290,00

Alabast Cable LED INTEGRADO

3 W / 80-264 V / 50-60 Hz
230 Lumen / 2700 K / CRI 80

Regulador de intensidad en cable

Alabast Cable INTEGRATED LED

3 W / 80-264 V / 50-60 Hz
230 Lumen / 2700 K / CRI 80

Dimmer on cable

BATERÍA RECARGABLE / RECHARGEABLE BATTERY

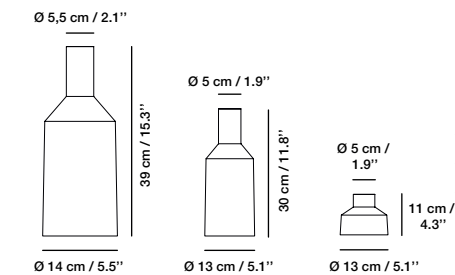

5141220
5131220
5121220

Estructura: Alabastro*
Batería recargable
Exterior - IP65
h39 cm / 15.3"
h30 cm / 11.8"
h11 cm / 4.3"



Structure: Alabaster*
Rechargeable battery
Outdoor - IP65
h39 cm / 15.3"
h30 cm / 11.8"
h11 cm / 4.3"



355,00
330,00
270,00

Alabast Batería Recargable LED INTEGRADO*

3,3 W / 100-240 V / 50-60 Hz
500 Lumen / 3000 K / CRI 80

Regulable con interruptor
Mando a distancia incluido

* Funcionamiento por batería.
Recarga por USB
Batería: autonomía de 8h aprox.

* Producto con vetas naturales
aleatorias

Alabast Rechargeable Battery INTEGRATED LED*

3,3 W / 100-240 V / 50-60 Hz
500 Lumen / 3000 K / CRI 80

Dimmer switch
Remote control included

* Battery operation.
Recharging by USB
Battery: autonomy of 8h approx.

* Product with random natural
veins

Boop!

APLIQUE-PLAFÓN / WALL-CEILING LAMP

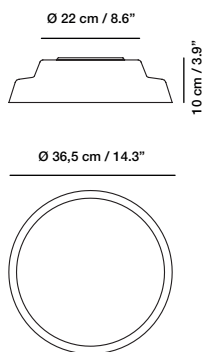

7481110
7481111
7481210
7481211
7481112
7481113
7481114

Estructura: metal
Cristal opal blanco

LED INTEGRADO

Exterior blanco + Interior blanco
Exterior blanco + Interior oro
Exterior negro + Interior blanco
Exterior negro + Interior oro
Exterior negro + Interior azul gris*
Exterior blanco + Interior azul gris*
Exterior blanco + Interior rojo*

Sin interruptor

LED INTEGRADO
20 W / 220-240 V / 50-60 Hz
2300 Lumen / 2700 K / CRI 80

Structure: metal
White opal glass

INTEGRATED LED

Outside white + Inside white
Outside white + Inside gold
Outside black + Inside white
Outside black + Inside gold
Outside black + Inside blue grey*
Outside white + Inside blue grey*
Outside white + Inside red*

Without switch

INTEGRATED LED
20 W / 220-240 V / 50-60 Hz
2300 Lumen / 2700 K / CRI 80

395,00
395,00
395,00
395,00
450,00
450,00
450,00



MODELO

COD.

ACABADOS

FINISHES

EUROS

Boop!

IN / OUTDOOR

APLIQUE-PLAFÓN / WALL-CEILING LAMP

IP55

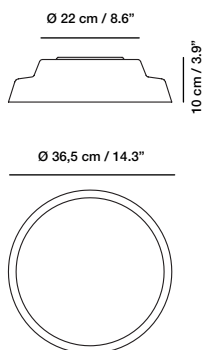

Estructura: metal
Cristal opal blanco

Structure: metal
White opal glass

LED INTEGRADO - IP55

INTEGRATED LED - IP55

7481130	Exterior blanco + Interior blanco	Outside white + Inside white	410,00
7481131	Exterior blanco + Interior oro	Outside white + Inside gold	410,00
7481230	Exterior negro + Interior blanco	Outside black + Inside white	410,00
7481231	Exterior negro + Interior oro	Outside black + Inside gold	410,00
7481132	Exterior negro + Interior azul gris*	Outside black + Inside blue grey*	460,00
7481133	Exterior blanco + Interior azul gris*	Outside white + Inside blue grey*	460,00
7481134	Exterior blanco + Interior rojo*	Outside white + Inside red*	460,00

*acabado metalizado

*metallic finish

Sin interruptor
Apto para baños

Without switch
Suitable for bathrooms

LED INTEGRADO
20 W / 220-240 V / 50-60 Hz
2300 Lumen / 2700 K / CRI 80

INTEGRATED LED
20 W / 220-240 V / 50-60 Hz
2300 Lumen / 2700 K / CRI 80

Boop! XL

APLIQUE-PLAFÓN / WALL-CEILING LAMP

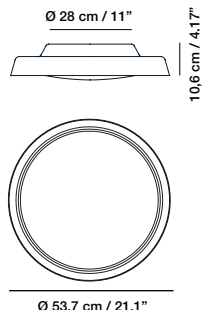

Estructura: metal
Cristal opal blanco

Structure: metal
White opal glass

LED INTEGRADO

INTEGRATED LED

6831301	Exterior negro + Interior oro	Outside black + Inside gold	750,00
6831303	Exterior negro + Interior blanco	Outside black + Inside white	750,00
6831300	Exterior blanco + Interior blanco	Outside white + Inside white	750,00
6831302	Exterior blanco + Interior oro	Outside white + Inside gold	750,00
6831306	Exterior negro + Interior azul gris*	Outside black + Inside blue grey*	1.030,00
6831305	Exterior blanco + Interior azul gris*	Outside white + Inside blue grey*	1.030,00
6831304	Exterior blanco + Interior rojo*	Outside white + Inside red*	1.030,00

*acabado metalizado

*metallic finish

Sin interruptor
Apto para baños

Without switch
Suitable for bathrooms

LED INTEGRADO
43 W / 90-295 V / 50-60 Hz
5800 Lumen / 3000 K / CRI 80

INTEGRATED LED
43 W / 90-295 V / 50-60 Hz
5800 Lumen / 3000 K / CRI 80



MODELO

COD.

ACABADOS

FINISHES

EUROS

Capsule

SOBREMESA / TABLE LAMP

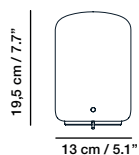

1001010

Estructura: alabastro
Base: latón envejecido

Structure: alabaster
Base: aged brass

Ht 19,5
7 W / 100-240 V / 50-60 Hz
500 Lumen / 1800-2700 K /
CRI 95

Ht 19,5
7 W / 100-240 V / 50-60 Hz
500 Lumen / 1800-2700 K /
CRI 95

495,00

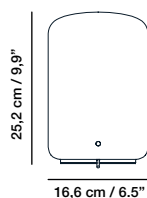

1001011

Ht 25,2
12 W / 100-240 V / 50-60 Hz
980 Lumen / 1800-2700 K /
CRI 95

Ht 25,2
12 W / 100-240 V / 50-60 Hz
980 Lumen / 1800-2700 K /
CRI 95

650,00

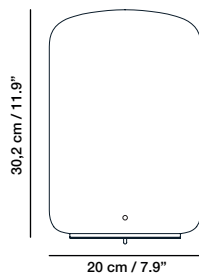

1001012

Ht 30,2
12 W / 100-240 V / 50-60 Hz
980 Lumen / 1800-2700 K /
CRI 95

Ht 30,2
12 W / 100-240 V / 50-60 Hz
980 Lumen / 1800-2700 K /
CRI 95

780,00

Equipada con Touchdim
LED INTEGRADO

Equipped with Touchdim
INTEGRATED LED

Carla

LAMPARA DE PIE / FLOOR LAMP

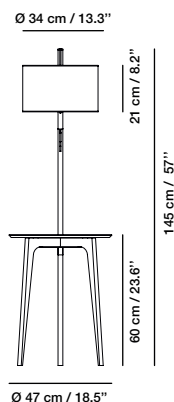

3071000

Estructura: madera de roble

Structure: oak wood

Roble natural

Natural oak

Pantalla: lino beige

Shade: linen beige

825,00

3071110

Pantalla: saguran (fibra natural)

Shade: saguran (natural fiber)

865,00

Roble negro

Black oak

3071200

Pantalla: blanca

Shade: white

825,00

Roble negro

Black oak

3071210

Pantalla: sagurán (fibra natural)

Shade: saguran (natural fiber)

865,00

Equipada con tirador

Equipped with pull switch

Sin bombilla

Without bulb



E27 LED

E27 LED

100 W / 220-240 V / 50-60 Hz

100 W / 220-240 V / 50-60 Hz

MODELO	COD.	ACABADOS	FINISHES	EUROS
Códol APLIQUE-PLAFÓN / WALL-CEILING LAMP	IN / OUTDOOR			
		2041100 Difusor en porcelana Blanco Sin interruptor Bombilla incluida LED GX53 6 W / 220-240 V / 50-60 Hz	Porcelain diffuser White Without switch Bulb included LED GX53 6 W / 220-240 V / 50-60 Hz	

Colette COLGANTE / SUSPENSION LAMP				
	3291100 Blanco 3291400 Terracota 3291700 Verde menta 3291200 Negro LED INTEGRADO 7 W / 100-240 V / 50-60 Hz 704 Lumen / 2700 K / CRI 90 Ángulo de apertura 120°	Structure: metal lacquered Ø 20 cm / 7.8" White Terracotta Mint green Black INTEGRATED LED 7 W / 100-240 V / 50-60 Hz 704 Lumen / 2700 K / CRI 90 120° lighting angle		335,00 335,00 335,00 335,00
	3041100 Blanco 3041400 Terracota 3041700 Verde menta 3041200 Negro LED INTEGRADO 18 W / 220-240 V / 50-60 Hz 2070 Lumen / 3000 K / CRI 80	Structure: metal lacquered Ø 40 cm / 15.7" White Terracotta Mint green Black INTEGRATED LED 18 W / 220-240 V / 50-60 Hz 2070 Lumen / 3000 K / CRI 80		470,00 470,00 470,00 470,00
		Equipada con cable eléctrico de 2 m (78.7")	Equipped with 2 m (78.7") of electric cable	



MODELO

COD.

ACABADOS

FINISHES

EUROS

Equilibrium

COLGANTE / SUSPENSION LAMP

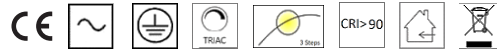
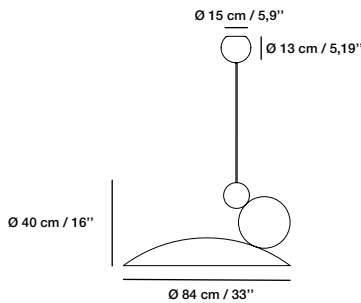
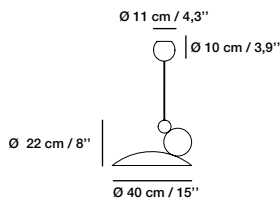
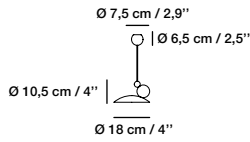

Estructura: metal

Structure: metal

Ø 18 cm / 7.1"

Ø 18 cm / 7.1"

- 1001034 Níquel negro brillante
- 1001035 Cobre brillante
- 1001036 Oro mate
- 1001037 Cromo mate

- Bright black nickel
- Bright copper
- Matt gold
- Matt chrome

- 570,00
- 570,00
- 650,00
- 570,00

LED INTEGRADO
7 W / 220-240 V / 50-60 Hz
704 Lumen / 2700 K / CRI 90

INTEGRATED LED
7 W / 220-240 V / 50-60 Hz
704 Lumen / 2700 K / CRI 90



Ø 40 cm / 15.7"

Ø 40 cm / 15.7"

- 1001038 Níquel negro brillante
- 1001039 Cobre brillante
- 1001040 Oro mate
- 1001041 Cromo mate

- Bright black nickel
- Bright copper
- Matt gold
- Matt chrome

- 1.050,00
- 1.050,00
- 1.150,00
- 1.050,00

LED INTEGRADO
22 W / 220-240 V / 50-60 Hz
2960 Lumen / 2700 K / CRI 80

INTEGRATED LED
22 W / 220-240 V / 50-60 Hz
2960 Lumen / 2700 K / CRI 80



Ø 85 cm / 33.5"

Ø 85 cm / 33.5"

- 1001042 Níquel negro brillante
- 1001043 Cobre brillante
- 1001044 Oro mate
- 1001045 Cromo mate

- Bright black nickel
- Bright copper
- Matt gold
- Matt chrome

- 3.950,00
- 3.950,00
- 4.250,00
- 3.950,00

LED INTEGRADO
42 W / 220-230 V / 50-60 Hz
5300 Lumen / 2700 K / CRI 80

INTEGRATED LED
42 W / 220-230 V / 50-60 Hz
5300 Lumen / 2700 K / CRI 80

Gala

LAMPARA DE PIE / FLOOR LAMP

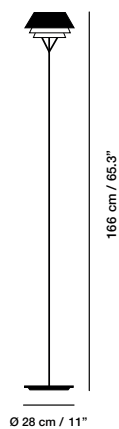

Estructura: metal

Structure: metal

- 1251900 Plomo metalizado
- 1251200 Negro

- Metal lead
- Black

- 535,00
- 535,00

Equipada con dimmer

Equipped with dimmer



Bombilla incluida
LED R7S 118mm
15 W / 220-240 V / 50-60 Hz

Bulb included
LED R7S 118mm
15 W / 220-240 V / 50-60 Hz

MODELO COD. ACABADOS FINISHES EUROS

Gala

APLIQUE / WALL LAMP

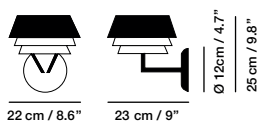

1181900	Estructura: metal	Structure: metal	345,00
1181200	Plomo metalizado	Metal lead	
	Negro	Black	345,00
	Sin interruptor	Without switch	
	Bombilla incluida LED R7S 118mm 15 W / 220-240 V / 50-60 Hz	Bulb included LED R7S 118mm 15 W / 220-240 V / 50-60 Hz	

Galilea

LAMPARA DE PIE / FLOOR LAMP

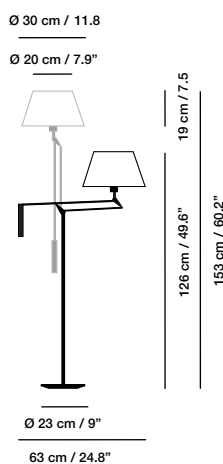

2681110	Estructura: metal	Structure: metal	415,00
2681114	Pantalla: algodón, blanca	Shade: cotton, white	
	Blanco	White	415,00
	Gris piedra	Stone grey	
	Brazo abatible y giratorio	Adjustable and movable arm	
	Interruptor en portalámparas	Switch on lamp holder	
	Sin bombilla E27 LED 100 W / 220-240 V / 50-60 Hz	Without bulb E27 LED 100 W / 220-240 V / 50-60 Hz	

Garçon

LAMPARA DE PIE / FLOOR LAMP

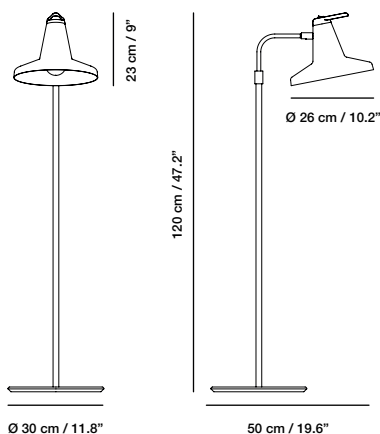

2071800	Estructura: metal negro	Structure: black metal	475,00
2071400	PANTALLA	SHADE	
2071310	Beige	Beige	475,00
2071200	Verde menta	Mint green	495,00
	Cobre	Copper	475,00
	Negro	Black	
	Regulable en altura y giratorio	Adjustable and rotating	
	Interruptor en el reflector	On-off switch on the reflector	
	Sin bombilla E27 LED 100 W / 220-240 V / 50-60 Hz	Without bulb E27 LED 100 W / 220-240 V / 50-60 Hz	

MODELO	COD.	ACABADOS	FINISHES	EUROS	
Garçon SOBREMESA / TABLE LAMP		CE	Estructura: metal negro PANTALLA 2561800 Beige 2561400 Verde menta 2561310 Cobre 2561200 Negro	Structure: black metal SHADE Beige Mint green Copper Black	395,00 395,00 455,00 395,00
			Giratorio Interruptor en el reflector Sin bombilla E27 LED 100 W / 220-240 V / 50-60 Hz	Rotating On-off switch on the reflector Without bulb E27 LED 100 W / 220-240 V / 50-60 Hz	

MODELO	COD.	ACABADOS	FINISHES	EUROS	
Garçon APLIQUE / WALL LAMP		CE	Estructura: metal negro Pantalla pequeña 2571800 Beige 2571400 Verde menta 2571310 Cobre 2571200 Negro	Structure: black metal Small shade Beige Mint green Copper Black	355,00 355,00 395,00 355,00
			Giratorio Interruptor en el reflector Sin bombilla E27 LED 100 W / 220-240 V / 50-60 Hz	Rotating On-off switch on the reflector Without bulb E27 LED 100 W / 220-240 V / 50-60 Hz	
GRANDE / LARGE		CE	Estructura: metal negro Pantalla grande 2581800 Beige 2581400 Verde menta 2581310 Cobre 2581200 Negro	Structure: black metal Large shade Beige Mint green Copper Black	395,00 395,00 450,00 395,00
			Giratorio Interruptor en el reflector Sin bombilla E27 LED 100 W / 220-240 V / 50-60 Hz	Rotating On-off switch on the reflector Without bulb E27 LED 100 W / 220-240 V / 50-60 Hz	

MODELO	COD.	ACABADOS	FINISHES	EUROS	
Greta LAMPARA DE PIE / FLOOR LAMP		CE	Estructura: madera de roble Madera de roble natural 2261000 Pantalla: saguran (fibra natural) 2261300 Pantalla: lino	Structure: oak wood Natural oak wood Shade: saguran (natural fiber) Shade: linen	598,00 598,00
			2261200 Pantalla: blanca 2261288 Pantalla: saguran (fibra natural) Asa: cuero Equipada con interruptor	Black oak wood Shade: white Shade: saguran (natural fiber) Handle: leather Equipped with switch	598,00 598,00
		Sin bombilla E27 LED 47 W / 220-240 V / 50-60 Hz	Without bulb E27 LED 47 W / 220-240 V / 50-60 Hz		

MODELO COD. ACABADOS FINISHES EUROS

Greta

SOBREMESA / TABLE LAMP

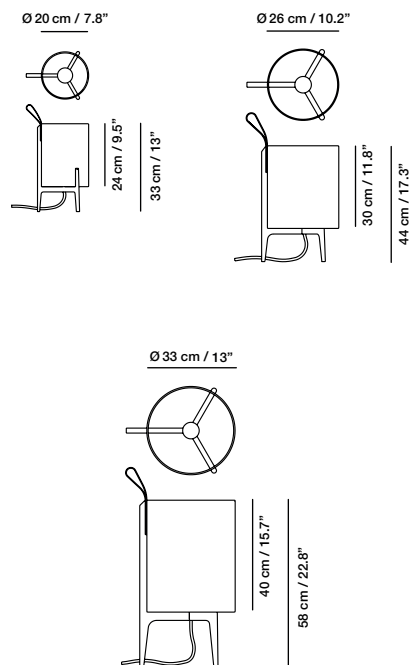

Estructura: madera de roble

Structure: oak wood

Madera de roble natural

Natural oak wood

Pantalla: saguran (fibra natural)

Shade: saguran (natural fiber)

2551000

Ø 20 cm / 7.8"

Ø 20 cm / 7.8"

310,00

2241000

Ø 26 cm / 10.2"

Ø 26 cm / 10.2"

365,00

2251000

Ø 33 cm / 13"

Ø 33 cm / 13"

450,00

Pantalla: lino

Shaded: linen

2551300

Ø 20 cm / 7.8"

Ø 20 cm / 7.8"

310,00

2241300

Ø 26 cm / 10.2"

Ø 26 cm / 10.2"

365,00

2251300

Ø 33 cm / 13"

Ø 33 cm / 13"

450,00

Madera de roble negro

Black oak wood

Pantalla: blanca

Shade: white

2551200

Ø 20 cm / 7.8"

Ø 20 cm / 7.8"

310,00

2241200

Ø 26 cm / 10.2"

Ø 26 cm / 10.2"

365,00

2251200

Ø 33 cm / 13"

Ø 33 cm / 13"

450,00

Madera de roble negro

Black oak wood

Pantalla: saguran (fibra natural)

Shade: saguran (natural fiber)

2551288

Ø 20 cm / 7.8"

Ø 20 cm / 7.8"

310,00

2241288

Ø 26 cm / 10.2"

Ø 26 cm / 10.2"

365,00

2251208

Ø 33 cm / 13"

Ø 33 cm / 13"

450,00

Asa: cuero

Handle: leather

Equipada con interruptor

Equipped with switch

E27 LED / Sin bombilla

E27 LED / Without bulb

Ø 20 cm / 7.8":

Ø 20 cm / 7.8":

30 W / 220-240 V / 50-60 Hz

30 W / 220-240 V / 50-60 Hz

Ø 26 cm / 10.2" - Ø 33 cm / 13":

Ø 26 cm / 10.2" - Ø 33 cm / 13":

47 W / 220-240 V / 50-60 Hz

47 W / 220-240 V / 50-60 Hz



Greta_battery

SOBREMESA / TABLE LAMP

Ø 16 cm / 6.2"

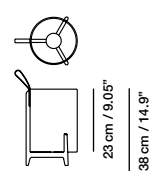

Ø 20 cm / 7.8"

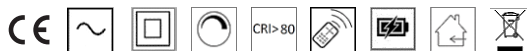
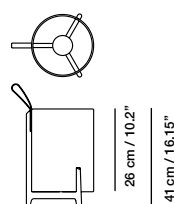

Estructura: madera de roble

Structure: oak wood

Madera de roble natural

Natural oak wood

Pantalla: saguran (fibra natural)

Shade: saguran (natural fiber)

1421000

Ø 16 cm / 6.2"

Ø 16 cm / 6.2"

340,00

1421400

Ø 20 cm / 7.8"

Ø 20 cm / 7.8"

350,00

Madera de roble negro

Black oak wood

Pantalla: blanca

Shade: white

1421200

Ø 16 cm / 6.6"

Ø 16 cm / 6.6"

340,00

1421300

Ø 20 cm / 7.8"

Ø 20 cm / 7.8"

350,00

Madera de roble negro

Black oak wood

Pantalla: saguran (fibra natural)

Shade: saguran (natural fiber)

1421208

Ø 16 cm / 6.6"

Ø 16 cm / 6.6"

340,00

1421308

Ø 20 cm / 7.8"

Ø 20 cm / 7.8"

350,00

Asa: cuero

Handle: leather

Regulable con interruptor

Dimmer switch

Mando a distancia incluido

Remote control included

LED INTEGRADO*

INTEGRATED LED*

3,3 W / 100-240 V / 50-60 Hz

3,3 W / 100-240 V / 50-60 Hz

500 Lumen / 3000 K / CRI 80

500 Lumen / 3000 K / CRI 80

* Funcionamiento por batería.

* Battery operation.

Recarga por USB

Recharging by USB

Batería: autonomía de 8h aprox.

Battery: autonomy of 8h approx.



MODELO

COD.

ACABADOS

FINISHES

EUROS

Greta

APLIQUE / WALL LAMP

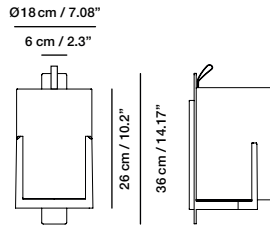

Estructura: madera de roble

Structure: oak wood

Ø 18 cm / 7.08"

Ø 18 cm / 7.08"

2531000

Madera de roble natural
Pantalla: saguran (fibra natural)

Natural oak wood
Shade: saguran (natural fiber)

345,00

2531200

Madera de roble negro
Pantalla: blanca

Black oak wood
Shade: white

345,00

2531201

Madera de roble negro
Pantalla: saguran (fibra natural)

Black oak wood
Shade: saguran (natural fiber)

345,00

Asa: cuero
Sin interruptor

Handle: leather
Without switch



Sin bombilla
E27 LED
30 W / 220-240 V / 50-60 Hz

Without bulb
E27 LED
30 W / 220-240 V / 50-60 Hz

Harry

LAMPARA DE PIE / FLOOR LAMP

IN / OUTDOOR

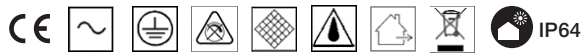
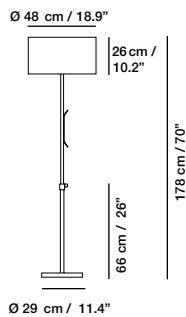

Pantalla: polietileno blanco
Pincho: acero inoxidable

Lampshade: white polyethylene
Spike: stainless steel

5511800

Base pie

Titanio
Blanco

Foot base

Titanium
White

598,00

5511100

Equipada con cable 9 m (354")
Sin interruptor

Equipped with 9 m (354") of cable
Without switch

598,00



Bombilla incluida
E27 LED
11 W / 220-240 V / 50-60 Hz

Bulb included
E27 LED
11 W / 220-240 V / 50-60 Hz

Harry plus

LAMPARA DE PIE / FLOOR LAMP

IN / OUTDOOR

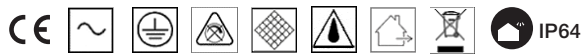
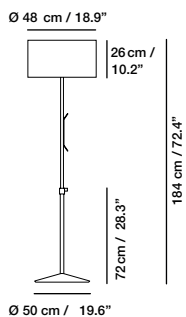

Pantalla: polietileno blanco
Pincho: acero inoxidable
Base pie: blanco

Lampshade: white polyethylene
Spike: stainless steel
Foot base: white

6601100

Equipada con cable 9 m (354")
Base muy pesada (13 Kg)
Sin interruptor

Equipped with 9 m (354") of cable
Very heavy base (13 Kg)
Without Switch

790,00



Bombilla incluida
E27 LED
11 W / 220-240 V / 50-60 Hz

Bulb included
E27 LED
11 W / 220-240 V / 50-60 Hz



MODELO

COD.

ACABADOS

FINISHES

EUROS

Hotel-python

APLIQUE / WALL LAMP

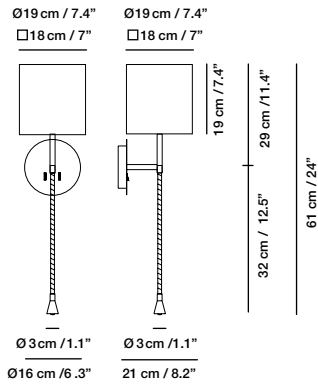

Flexión máxima 90° /
Maximum flexion 90°



Estructura: metal
Pantalla: algodón

Structure: metal
Shade: cotton

Pantalla cuadrada

Square shade

1011000	Níquel mate + Pantalla blanca	Matt nickel + White shade	260,00
1011003	Níquel mate + Pantalla beige	Matt nickel + Beige shade	260,00
1011002	Níquel mate + Pantalla negra	Matt nickel + Black shade	260,00
1011300	Blanco + Pantalla blanca	White + White shade	260,00
1011301	Blanco + Pantalla beige	White + Beige shade	260,00
1011302	Blanco + Pantalla negra	White + Black shade	260,00
	Pantalla redonda	Round shade	
1011010	Níquel mate + Pantalla blanca	Matt nickel + White shade	260,00
1011011	Níquel mate + Pantalla beige	Matt nickel + Beige shade	260,00
1011012	Níquel mate + Pantalla negra	Matt nickel + Black shade	260,00
1011310	Blanco + Pantalla blanca	White + White shade	260,00
1011311	Blanco + Pantalla beige	White + Beige shade	260,00
1011312	Blanco + Pantalla negra	White + Black shade	260,00

Otros colores pantalla consultar
2 Interruptores en la base

Other shade colours upon request
2 Switches on the base



Sin bombilla
E14 LED
15 W / 220-240 V / 50-60 Hz

Without bulb
E14 LED
15 W / 220-240 V / 50-60 Hz

Flexo

LED INTEGRADO
2 W / 100-240 V / 50-60 Hz
65 Lumen / 3000 K
Ángulo de apertura 80°

Flexo

INTEGRATED LED
2 W / 100-240 V / 50-60 Hz
65 Lumen / 3000 K
80° lighting angle

Isamu

LAMPARA DE PIE / FLOOR LAMP

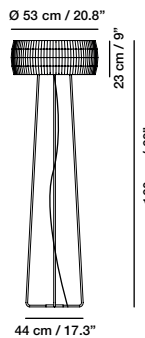

Estructura: metal lacado negro
Pantalla: encintada

Structure: black lacquer metal
Shade: ribboned

6391100	Blanca	White	595,00
6391800	Perla	Pearl	595,00
6391700	Verde oliva	Olive green	595,00

Otros colores pantalla consultar
Equipada con interruptor

Other shade colours upon request
Equipped with switch



Sin bombilla
2 x E27 LED
100 W / 220-240 V / 50-60 Hz

Without bulb
2 x E27 LED
100 W / 220-240 V / 50-60 Hz

MODELO

COD.

ACABADOS

FINISHES

EUROS

Isamu

SOBREMESA / TABLE LAMP

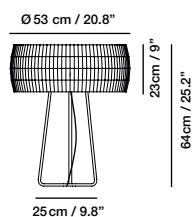

Estructura: metal lacado negro
Pantalla: encintada

Structure: black lacquer metal
Shade: ribboned

6381100

Blanca

White

499,00

6381800

Perla

Pearl

499,00

6381700

Verde oliva

Olive green

499,00

Otros colores pantalla consultar
Equipada con interruptor

Other shade colours upon request
Equipped with switch



Sin bombilla
2 x E27 LED

Without bulb
2 x E27 LED

100 W / 220-240 V / 50-60 Hz

100 W / 220-240 V / 50-60 Hz

Isamu

COLGANTE / SUSPENSION LAMP

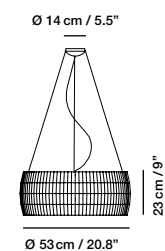

Estructura: metal lacado negro
Pantalla: encintada
Incluye difusor de policarbonato blanco

Structure: black lacquer metal
Shade: ribboned
White polycarbonate diffuser included

Ø 53 cm / 20.8"

6351100

Blanca

Ø 53 cm / 20.8"

White

499,00

6351800

Perla

Pearl

499,00

6351700

Verde oliva

Olive green

499,00

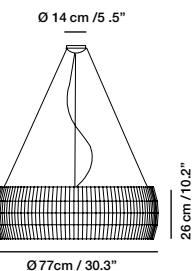

Ø 77 cm / 30.3"

6361100

Blanca

Ø 77 cm / 30.3"

White

725,00

6361800

Perla

Pearl

725,00

6361700

Verde oliva

Olive green

725,00

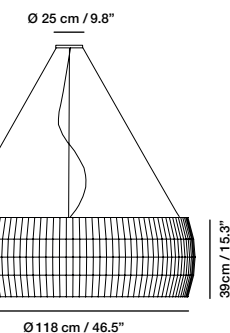

Ø 118 cm / 46.5"

6371100

Blanca

Ø 118 cm / 46.5"

White

1.250,00

6371800

Perla

Pearl

1.250,00

6371700

Verde oliva

Olive green

1.250,00

Otros colores pantalla consultar
Equipada con cable eléctrico de 2 m (78.7")

Other shade colours upon request
Equipped with 2 m (78.7") of electric cable



Sin bombilla
- Ø 53 cm / 20.8": 2 x E27 LED
- Ø 77 cm / 30.3": 2 x E27 LED
- Ø 118 cm / 46.5": 4 x E27 LED

Without bulb
- Ø 53 cm / 20.8": 2 x E27 LED
- Ø 77 cm / 30.3": 2 x E27 LED
- Ø 118 cm / 46.5": 4 x E27 LED

100 W / 220-240 V / 50-60 Hz

100 W / 220-240 V / 50-60 Hz



MODELO

COD.

ACABADOS

FINISHES

EUROS

Isamu

PLAFÓN / CEILING LAMP

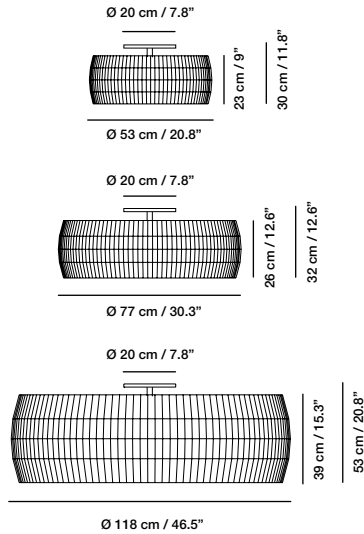

Estructura: metal lacado negro
Pantalla: encintada
Incluye difusor de policarbonato blanco

Structure: black lacquer metal
Shade: ribboned
White polycarbonate diffuser included

COD.	ACABADOS	FINISHES	EUROS
6321100	Blanca	White	440,00
6321800	Perla	Pearl	440,00
6321700	Verde oliva	Olive green	440,00
Ø 53 cm / 20.8"			
6331100	Blanca	White	650,00
6331800	Perla	Pearl	650,00
6331700	Verde oliva	Olive green	650,00
Ø 77 cm / 30.3"			
6341100	Blanca	White	1.150,00
6341800	Perla	Pearl	1.150,00
6341700	Verde oliva	Olive green	1.150,00
Ø 118 cm / 46.5"			

Otros colores pantalla consultar
Sin interruptor

Other shade colours upon request
Without switch

Sin bombilla

Without bulb

- Ø 53 cm / 20.8": 2 x E27 LED
- Ø 77 cm / 30.3": 2 x E27 LED
- Ø 118 cm / 46.5": 4 x E27 LED

- Ø 53 cm / 20.8": 2 x E27 LED
- Ø 77 cm / 30.3": 2 x E27 LED
- Ø 118 cm / 46.5": 4 x E27 LED

100 W / 220-240 V / 50-60 Hz

100 W / 220-240 V / 50-60 Hz

Jerry

LAMPARA DE PIE / FLOOR LAMP

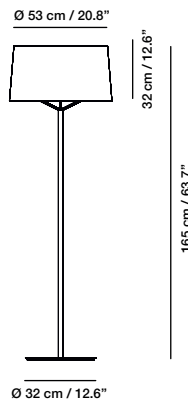

Estructura: metal
Pantalla: algodón

Structure: metal
Shade: cotton

1431100	Blanco + Pantalla blanca	White + White shade	600,00
1431110	Blanco + Pantalla beige	White + Beige shade	600,00
1431000	Níquel mate + Pantalla blanca	Matt nickel + White shade	780,00
1431010	Níquel mate + Pantalla beige	Matt nickel + Beige shade	780,00
1431200	Negro + Pantalla blanca	Black + White shade	600,00

Otros colores pantalla consultar
Equipada con interruptor

Other shade colours upon request
Equipped with switch

Sin bombilla

Without bulb

2 x E27 LED
100 W / 220-240 V / 50-60 Hz

2 x E27 LED
100 W / 220-240 V / 50-60 Hz

MODELO COD. ACABADOS FINISHES EUROS

Jerry

SOBREMESA / TABLE LAMP



Estructura: metal
Pantalla: algodón

Structure: metal
Shade: cotton

PEQUEÑO / SMALL

Ø 35 cm / 13.7"

Ø 30 cm / 11.8"

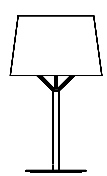

20 cm / 7.8"
53 cm / 20.8"

Ø 19.5 cm / 7.6"

1441100
1441110
1441000
1441010
1441200

Ø35 cm / 13.7"
Blanco + Pantalla blanca
Blanco + Pantalla beige
Níquel mate + Pantalla blanca
Níquel mate + Pantalla beige
Negro + Pantalla blanca

Ø35 cm / 13.7"
White + White shade
White + Beige shade
Matt nickel + White shade
Matt nickel + Beige shade
Black + White shade

340,00
340,00
380,00
380,00
340,00

GRANDE / LARGE

Ø 45 cm / 17.7"

Ø 40 cm / 15.7"

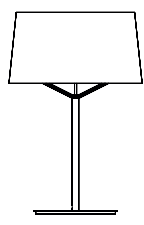

24 cm / 9.4"
65 cm / 25.6"

Ø 23 cm / 9"

2191100
2191110
2191000
2191010
2191200

Ø45 cm / 17.7"
Blanco + Pantalla blanca
Blanco + Pantalla beige
Níquel mate + Pantalla blanca
Níquel mate + Pantalla beige
Negro + Pantalla blanca

Ø45 cm / 17.7"
White + White shade
White + Beige shade
Matt nickel + White shade
Matt nickel + Beige shade
Black + White shade

415,00
415,00
465,00
465,00
415,00

Otros colores pantalla consultar
Equipada con interruptor

Other shade colours upon request
Equipped with switch

Sin bombilla
- Pequeño:
1 x E27 LED
60 W / 220-240 V / 50-60 Hz
- Grande:
2 x E27 LED
100 W / 220-240 V / 50-60 Hz

Without bulb
- Small:
1 x E27 LED
60 W / 220-240 V / 50-60 Hz
- Large:
2 x E27 LED
100 W / 220-240 V / 50-60 Hz



Jerry

APLIQUE / WALL LAMP



Estructura: metal
Foco giratorio 360°

Structure: metal
360° rotating focus

EMPOTRADA / BUILD IN

Sin interruptor / Without switch

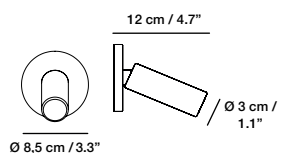

Ø 8,5 cm / 3.3"

6961001
6961000
6961100
6961200

EMPOTRADA
Sin interruptor
Cromo
Níquel mate
Blanco
Negro

BUILD IN
Without switch
Chrome
Nickel matt
White
Black

190,00
190,00
180,00
180,00

Con interruptor / With switch

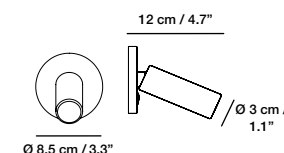

Ø 8,5 cm / 3.3"

6951001
6951000
6951100
6951200

Con interruptor
Cromo
Níquel mate
Blanco
Negro

With switch
Chrome
Nickel matt
White
Black

190,00
195,00
185,00
185,00

SUPERFICIE / SURFACE

Con interruptor / With switch

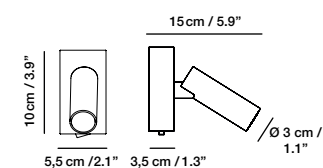

10 cm / 3.9"
5,5 cm / 2.1" 3,5 cm / 1.3" Ø 3 cm / 1.1"

6971001
6971000
6971100
6971200

SUPERFICIE
Con interruptor
Cromo
Níquel mate
Blanco
Negro

SURFACE
With switch
Chrome
Nickel matt
White
Black

210,00
210,00
195,00
195,00

LED INTEGRADO
2 W / 100-240 V / 50-60 Hz
65 Lumen / 3000 K / CRI 80
Ángulo de apertura 60°

INTEGRATED LED
2 W / 100-240 V / 50-60 Hz
65 Lumen / 3000 K / CRI 80
60° lighting angle



MODELO

COD.

ACABADOS

FINISHES

EUROS

Jerry-hotel

APLIQUE / WALL LAMP

JERRY-HOTEL A

Pantalla cónica / Conical shade

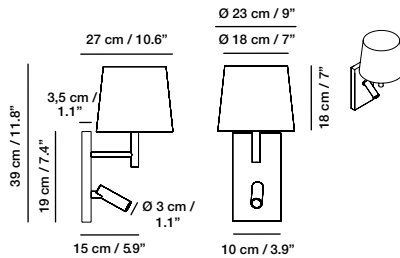

JERRY-HOTEL B

Pantalla piramidal / Pyramidal shade

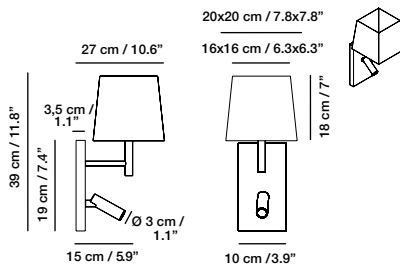

Estructura: metal
Pantalla: algodón
Foco giratorio de 360°

Structure: metal
Shade: cotton
360° rotating focus

6881011

A. Pantalla cónica

Níquel mate + Pantalla blanca

6881010

Níquel mate + Pantalla beige

6881111

Blanco + Pantalla blanca

6881110

Blanco + Pantalla beige

6881021

B. Pantalla piramidal

Níquel mate + Pantalla blanca

6881020

Níquel mate + Pantalla beige

6881121

Blanco + Pantalla blanca

6881120

Blanco + Pantalla beige

A. Conical shade

Nickel matt + White shade

Nickel matt + Beige shade

White + White shade

White + Beige shade

B. Pyramidal shade

Nickel matt + White shade

Nickel matt + Beige shade

White + White shade

White + Beige shade

320,00

320,00

265,00

265,00

320,00

320,00

265,00

265,00

Otros colores pantalla consultar
Equipado con 2 interruptores

Other shade colours upon request
Equipped with 2 switches

Sin bombilla

Without bulb

Base

E14 LED

60 W / 220-240 V / 50-60 Hz

Base

E14 LED

60 W / 220-240 V / 50-60 Hz

Foco

LED INTEGRADO

2 W / 100-240 V / 50-60 Hz

65 Lumen / 3000 K

Ángulo de apertura 60°

Focus

INTEGRATED LED

2 W / 100-240 V / 50-60 Hz 65

Lumen / 3000 K

60° lighting angle

Kelly

LAMPARA DE PIE / FLOOR LAMP

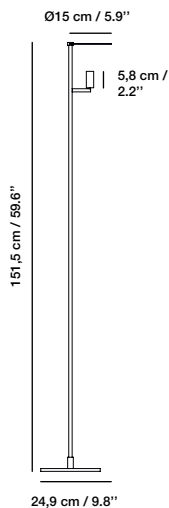

Estructura: metal

Structure: metal

3141000

Oro / Rótula oro

Gold / Gold joint

595,00

3141101

Blanco / Rótula níquel

White / Nickel joint

460,00

3141200

Negro / Rótula oro

Black / Gold joint

460,00

3141201

Negro / Rótula níquel

Black / Nickel joint

460,00

Foco abatible y orientable

Equipado con interruptor

Adjustable and movable spotlight

Equipped with switch

LED INTEGRADO

3,2 W / 100-240 V / 50-60 Hz

420 Lumen / 2700 K / CRI 80

Apertura de ángulo 50°

INTEGRATED LED

3,2 W / 100-240 V / 50-60 Hz

420 Lumen / 2700 K / CRI 80

50° lighting angle

MODELO

COD.

ACABADOS

FINISHES

EUROS

Kelly

SOBREMESA / TABLE LAMP

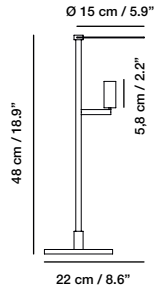

Estructura: metal

Structure: metal

3131000

Oro / Rótula oro

Gold / Gold joint

425,00

3131101

Blanco / Rótula níquel

Blanco / Nickel joint

380,00

3131200

Negro / Rótula oro

Black / Gold joint

380,00

3131201

Negro / Rótula níquel

Black / Nickel joint

380,00

Foco abatible y orientable
Equipado con interruptor

Adjustable and movable spotlight
Equipped with switch

LED INTEGRADO

INTEGRATED LED

3,2 W / 100-240 V / 50-60 Hz

3,2 W / 100-240 V / 50-60 Hz

420 Lumen / 2700 K / CRI 80

420 Lumen / 2700 K / CRI 80

Apertura de ángulo 50°

50° lighting angle

Kelly

APLIQUE / WALL LAMP

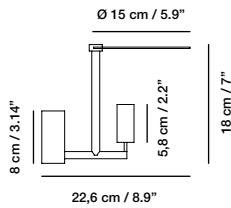

Estructura: metal

Structure: metal

3121000

Oro / Rótula oro

Gold / Gold joint

395,00

3121101

Blanco / Rótula níquel

Blanco / Nickel joint

325,00

3121200

Negro / Rótula oro

Black / Gold joint

325,00

3121201

Negro / Rótula níquel

Black / Nickel joint

325,00

Foco abatible y orientable
Sin interruptor

Adjustable and movable spotlight
Without switch

LED INTEGRADO

INTEGRATED LED

3,2 W / 100-240 V / 50-60 Hz

3,2 W / 100-240 V / 50-60 Hz

340 Lumen / 2700 K / CRI 80

340 Lumen / 2700 K / CRI 80

Apertura de ángulo 50°

50° lighting angle



MODELO

COD.

ACABADOS

FINISHES

EUROS

Lineal

COLGANTE / SUSPENSION LAMP

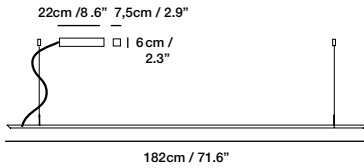
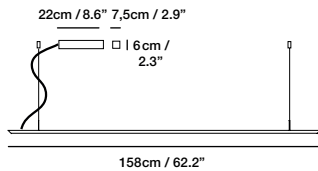
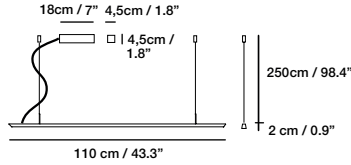

Estructura: aluminio

Structure: aluminum

110 cm / 43.3"	110 cm / 43.3"	
Níquel mate	Matt nickel	480,00
7361000	Blanco	455,00
7361100	Negro	455,00
158 cm / 62.2"	158 cm / 62.2"	
Níquel mate	Matt nickel	550,00
7351000	Blanco	480,00
7351100	Negro	480,00
182 cm / 71.6"	182 cm / 71.6"	
Níquel mate	Matt nickel	575,00
6921000	Blanco	530,00
6921100	Negro	530,00

Cable ajustable en acero inoxidable de 3,5 m (137.7") de largo Sin interruptor

Adjustable stainless steel cable up to 3,5 m (137.7") length Without switch

LED INTEGRADO

INTEGRATED LED

100-240 V / 2700 K / CRI 80	100-240 V / 2700 K / CRI 80
- 110 cm / 43.3": 20 W / 2175 Lumen	- 110 cm / 43.3": 20 W / 2175 Lumen
- 158 cm / 62.2": 28 W / 3320 Lumen	- 158 cm / 62.2": 28 W / 3320 Lumen
- 182 cm / 71.6": 31 W / 3664 Lumen	- 182 cm / 71.6": 31 W / 3664 Lumen
Ángulo de apertura 120°	120° lighting angle

Lineal

APLIQUE / WALL LAMP

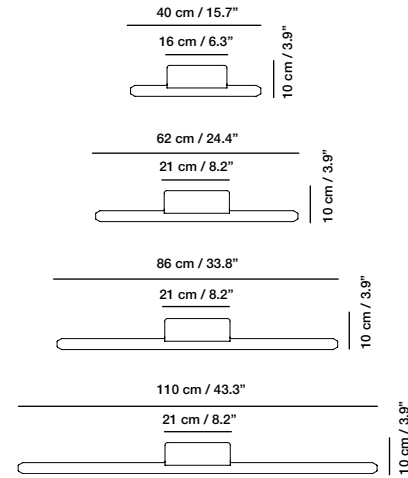

Estructura: aluminio

Structure: aluminum

40 cm / 15.7"	40 cm / 15.7"	
Níquel mate	Matt nickel	350,00
7511000	Blanco	330,00
7511100	Negro	330,00
62 cm / 24.4"	62 cm / 24.4"	
Níquel mate	Matt nickel	370,00
6941000	Blanco	350,00
6941100	Negro	350,00
86 cm / 33.8"	86 cm / 33.8"	
Níquel mate	Matt nickel	390,00
7401000	Blanco	365,00
7401100	Negro	365,00
110 cm / 43.3"	110 cm / 43.3"	
Níquel mate	Matt nickel	430,00
7411000	Blanco	405,00
7411100	Negro	405,00

Emisión de luz directa o indirecta Sin interruptor

Direct or indirect lighting Without switch

LED INTEGRADO

INTEGRATED LED

100-240 V / 2700 K / CRI 80	100-240 V / 2700 K / CRI 80
- 40 cm / 15.7": 11 W / 801 Lumen	- 40 cm / 15.7": 11 W / 801 Lumen
- 62 cm / 24.4": 11 W / 1260 Lumen	- 62 cm / 24.4": 11 W / 1260 Lumen
- 86 cm / 33.8": 16 W / 1830 Lumen	- 86 cm / 33.8": 16 W / 1830 Lumen
- 110 cm / 43.3": 21 W / 2404 Lumen	- 110 cm / 43.3": 21 W / 2404 Lumen
Ángulo de apertura 120°	120° lighting angle

MODELO

COD.

ACABADOS

FINISHES

EUROS

Lineal biblo

SOBREMESA / TABLE LAMP

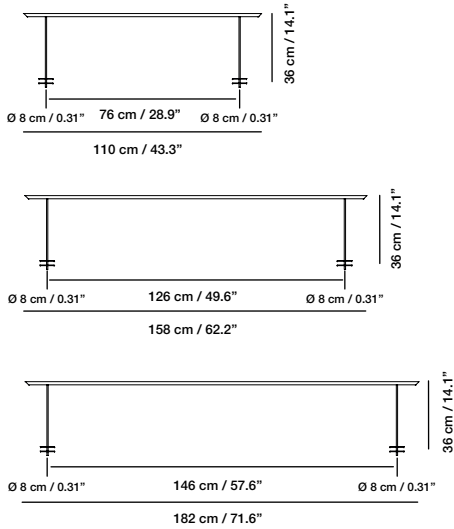

Estructura: aluminio
Sin Interruptor

Structure: aluminum
Without switch

7381000	110 cm / 43.3"	Níquel mate	Matt nickel	495,00
7381100		Blanco	White	470,00
7381200		Negro	Black	470,00
7371000	158 cm / 62.2"	Níquel mate	Matt nickel	580,00
7371100		Blanco	White	530,00
7371200		Negro	Black	530,00
6911000	182 cm / 71.6"	Níquel mate	Matt nickel	660,00
6911100		Blanco	White	610,00
6911200		Negro	Black	610,00
		Con interruptor		
		With switch		
7381000S	110 cm / 43.3"	Níquel mate	Matt nickel	515,00
7381100S		Blanco	White	490,00
7381200S		Negro	Black	490,00
7371000S	158 cm / 62.2"	Níquel mate	Matt nickel	590,00
7371100S		Blanco	White	550,00
7371200S		Negro	Black	550,00
6911000S	182 cm / 71.6"	Níquel mate	Matt nickel	680,00
6911100S		Blanco	White	630,00
6911200S		Negro	Black	630,00

Fijación a la mesa mediante dos arandelas tipo sándwich

Fix table system with two sandwich rings

LED INTEGRADO

100-240 V / 2700 K / CRI 80

- 110 cm / 43.3": 15 W / 1603 Lumen

- 158 cm / 62.2": 30 W / 2748 Lumen

- 182 cm / 71.6": 30 W / 3206 Lumen

Ángulo de apertura 120°

INTEGRATED LED

100-240 V / 2700 K / CRI 80

- 110 cm / 43.3": 15 W / 1603 Lumen

- 158 cm / 62.2": 30 W / 2748 Lumen

- 182 cm / 71.6": 30 W / 3206 Lumen

120° lighting angle

Lineal

LAMPARA DE PIE / FLOOR LAMP

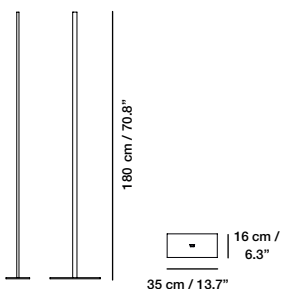

Estructura: aluminio

Structure: aluminum

2291000	Níquel mate	Matt nickel	595,00
2291100	Blanco	White	510,00
2291200	Negro	Black	510,00

Luz indirecta
Equipado con interruptor

Indirect lighting
Equipped with switch

LED INTEGRADO

3,2 W / 100-240 V / 50-60 Hz







2400 Lumen / 2700 K / CRI 80



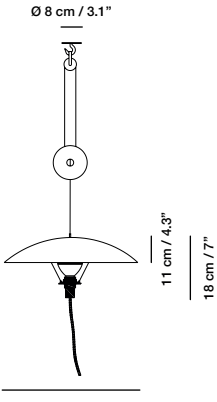



INTEGRATED LED

3,2 W / 100-240 V / 50-60 Hz

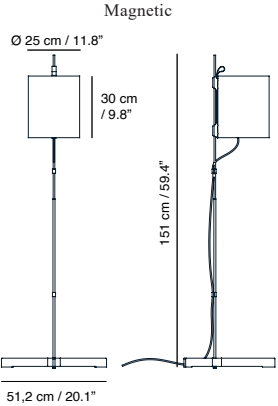
2400 Lumen / 2700 K / CRI 80



MODELO	COD.	ACABADOS	FINISHES	EUROS
Macao COLGANTE / SUSPENSION LAMP 		     		
	Pantalla: metal Interior pantalla siempre blanco Regulable en altura Interruptor en el portalámparas Equipada con 4 m (157") de cable Bombilla incluida E27 Par 30 LED 10 W / 220-240 V / 50-60 Hz 850 Lumen / 3000 K	Shade: metal Inside shade always white Height adjustable Switch on the lampholder Equipped with 4 m (157") of cable Bulb included E27 Par 30 LED 10 W / 220-240 V / 50-60 Hz 850 Lumen / 3000 K	6441100 6441200	Matt white Matt black

Magnetic LAMPARA DE PIE / FLOOR LAMP 		     			
	Estructura: metal y madera Pantalla: tejido Magnetic Roble natural Pantalla: sagurán (fibra natural)	Structure: metal and wood Shade: fabric Magnetic Natural oak Pantalla: saguran (natural fiber)	1001016 1001018	620,00 680,00	
	Magnetic Foco Roble natural Pantalla: sagurán (fibra natural)	Magnetic Foco Natural oak Pantalla: saguran (natural fiber)	1001017	650,00	
	Roble negro Pantalla: caqui	Black oak Shade: khaki	1001019	720,00	
	Foco abatible y orientable Equipado con interruptor Sin bombilla E27 LED 20 W / 220-240 V / 50-60 Hz	Adjustable and movable spotlight Equipped with switch Bulb not included E27 LED Max 20 watts 20 W / 220-240 V / 50-60 Hz			

MODELO COD. ACABADOS FINISHES EUROS

Mandarina

COLGANTE / SUSPENSION LAMP

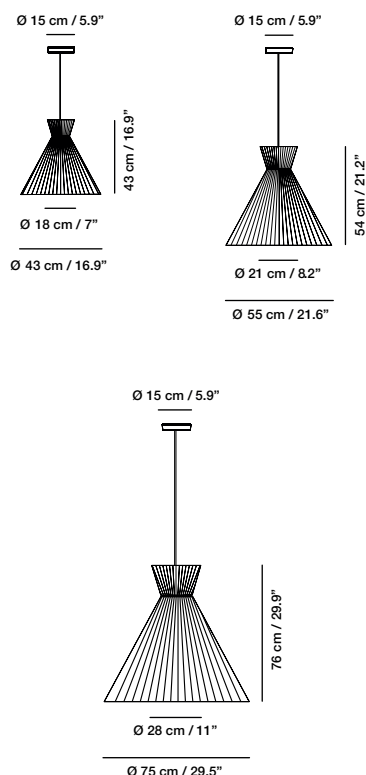

Pantalla: encintada
 Incluye difusor de policarbonato blanco

Shade: ribboned
 White polycarbonate difuser included

COD.	ACABADOS	FINISHES	EUROS
6671100	Blanco	White	515,00
6671800	Perla	Pearl	515,00
6671700	Verde oliva	Olive green	515,00
6681100	Blanco	White	610,00
6681800	Perla	Pearl	610,00
6681700	Verde oliva	Olive green	610,00
6691100	Blanco	White	885,00
6691800	Perla	Pearl	885,00
6691700	Verde oliva	Olive green	885,00

Otros colores pantalla consultar
 Equipada con cable eléctrico de 2 m (78.7")

Other shade colours upon request
 Equipped with 2 m (78.7") of electric cable



Sin bombilla
 E27 LED
 30 W / 220-240 V / 50-60 Hz
 - Ø 43 cm / 16.9": 1 x E27 LED
 - Ø 55 cm / 21.6": 2 x E27 LED
 - Ø 75 cm / 29.5": 3 x E27 LED

Without bulb
 E27 LED
 30 W / 220-240 V / 50-60 Hz
 - Ø 43 cm / 16.9": 1 x E27 LED
 - Ø 55 cm / 21.6": 2 x E27 LED
 - Ø 75 cm / 29.5": 3 x E27 LED

Margot

SOBREMESA / TABLE LAMP

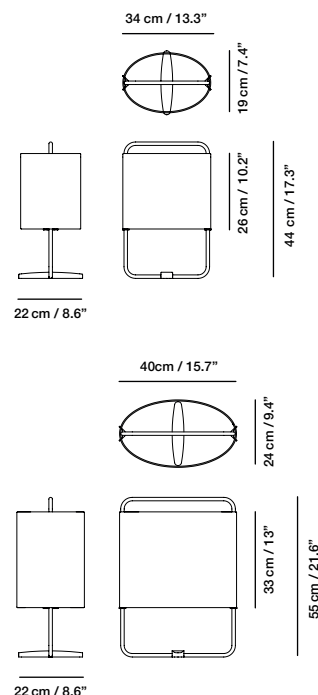

Estructura: metal
 Pantalla: tejido

Structure: metal
 Shade: fabric

COD.	ACABADOS	FINISHES	EUROS
2271001	Nácar	Nacre	355,00
2271002	Níquel negro mate	Matt black nickel	415,00
2271003	Oro mate	Matt gold	415,00
2271004	Cobre mate	Matt copper	395,00
2281001	Nácar	Nacre	380,00
2281002	Níquel negro mate	Matt black nickel	455,00
2281003	Oro mate	Matt gold	455,00
2281004	Cobre mate	Matt copper	415,00



Sin bombilla
 E27 LED
 20 W / 220-240 V / 50-60 Hz

Without bulb
 E27 LED
 20 W / 220-240 V / 50-60 Hz

MODELO COD. ACABADOS FINISHES EUROS

Mei

SOBREMESA / TABLE LAMP

Difusor A / Diffuser A

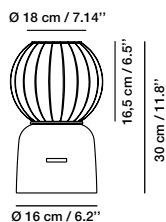

Difusor B / Diffuser B

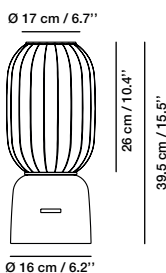

Difusor: porcelana
Base: cerámica

Diffuser: porcelain
Base: Ceramic

Difusor A

- 3361001** Base gris + Aro oro
- 3361002** Base gris + Aro negro
- 3361003** Base rosa + Aro oro
- 3361004** Base rosa + Aro negro
- 3361005** Base verde menta + Aro oro
- 3361006** Base verde menta + Aro negro

Diffuser A

- Grey base + Gold ring
- Grey base + Black ring
- Rose base + Gold ring
- Rose base + Black ring
- Mint green base + Gold ring
- Mint green base + Black ring

- 420,00**
- 420,00**
- 420,00**
- 420,00**
- 420,00**
- 420,00**

Difusor B

- 3361007** Base gris + Aro oro
- 3361008** Base gris + Aro negro
- 3361009** Base rosa + Aro oro
- 3361010** Base rosa + Aro negro
- 3361011** Base verde menta + Aro oro
- 3361012** Base verde menta + Aro negro

Diffuser B

- Grey base + Gold ring
- Grey base + Black ring
- Rose base + Gold ring
- Rose base + Black ring
- Mint green base + Gold ring
- Mint green base + Black ring

- 420,00**
- 420,00**
- 420,00**
- 420,00**
- 420,00**
- 420,00**

Equipado con interruptor

Equipped with switch



Sin bombilla
E27 LED
15 W / 220-240 V / 50-60 Hz

Without bulb
E27 LED
15 W / 220-240 V / 50-60 Hz

Mei

APLIQUE / WALL LAMP

Difusor A / Diffuser A

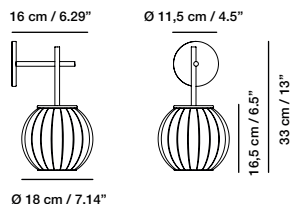

Difusor B / Diffuser B

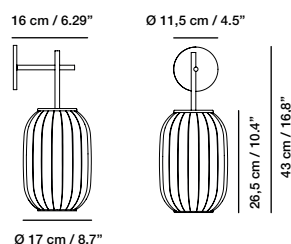

Estructura: metal
Difusor: porcelana

Structure: metal
Diffuser: porcelain

Difusor A

- 3311100** Estructura Blanca
- 3311200** Estructura Negra
- 3311000** Estructura Oro

Diffuser A

- White Structure
- Black Structure
- Gold Structure

- 295,00**
- 295,00**
- 340,00**

Difusor B

- 3321100** Estructura Blanca
- 3321200** Estructura Negra
- 3321000** Estructura Oro

Diffuser B

- White Structure
- Black Structure
- Gold Structure

- 325,00**
- 325,00**
- 375,00**

Sin interruptor

Without switch



Sin bombilla
E27 LED
25 W / 220-240 V / 50-60 Hz

Without bulb
E27 LED
25 W / 220-240 V / 50-60 Hz

MODELO

COD.

ACABADOS

FINISHES

EUROS

Mei

COLGANTE / SUSPENSION LAMP

Difusor A / Diffuser A

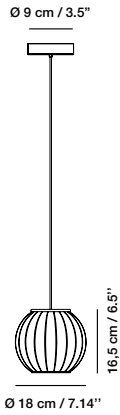

Difusor B / Diffuser B

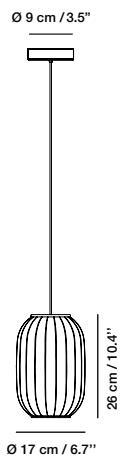

Difusor C / Diffuser C

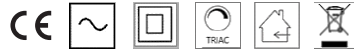
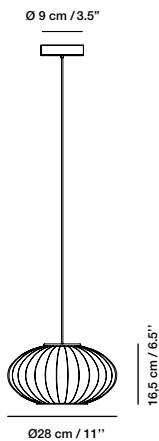

Estructura: metal
Difusor: porcelana

Structure: metal
Diffuser: porcelain

Difusor A

- 3331100 Estructura Blanca
- 3331200 Estructura Negra
- 3331000 Estructura Oro

Diffuser A

- White Structure
- Black Structure
- Gold Structure

- 230,00
- 230,00
- 280,00

Peso Neto 0,77 kg

Equipada con cable eléctrico de 2 m (78.7")

Net Weight 0,77 kg

Equipped with 2 m (78.7") of electric cable

Difusor B

- 3341100 Estructura Blanca
- 3341200 Estructura Negra
- 3341000 Estructura Oro

Diffuser B

- White Structure
- Black Structure
- Gold Structure

- 275,00
- 275,00
- 320,00

Peso Neto 1,05 kg

Equipada con cable eléctrico de 2 m (78.7")

Net Weight 1,05 kg

Equipped with 2 m (78.7") of electric cable

Difusor C

- 3351100 Estructura Blanca
- 3351200 Estructura Negra
- 3351000 Estructura Oro

Diffuser C

- White Structure
- Black Structure
- Gold Structure

- 305,00
- 305,00
- 345,00

Peso Neto 1,62 kg

Equipada con cable eléctrico de 2 m (78.7")

Net Weight 1,62 kg

Equipped with 2 m (78.7") of electric cable



Sin bombilla
E27 LED
25 W / 220-240 V / 50-60 Hz

Without bulb
E27 LED
25 W / 220-240 V / 50-60 Hz

Para adaptar a Florón A / To adapt to Canopy A

Ver página 48 / See page 48

MODELO COD. ACABADOS FINISHES EUROS

Mei

COLGANTE / SUSPENSION LAMP

Difusor A / Diffuser A



Difusor B / Diffuser B

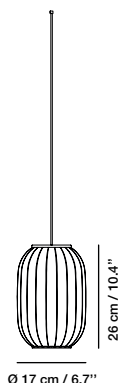

Difusor C / Diffuser C

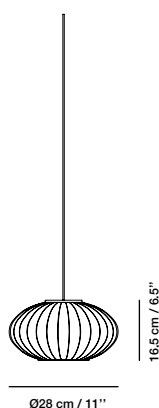

Difusor: porcelana

Diffuser: porcelain

Difusor A

Diffuser A

3331100C Estructura Blanca

White Structure

230,00

3331200C Estructura Negra

Black Structure

230,00

3331000C Estructura Oro

Gold Structure

280,00

Peso Neto 0,65 kg

Net Weight 0,65 kg

Equipada con cable eléctrico de 2 m (78.7")

Equipped with 2 m (78.7") of electric cable

Difusor B

Diffuser B

3341100C Estructura Blanca

White Structure

275,00

3341200C Estructura Negra

Black Structure

275,00

3341000C Estructura Oro

Gold Structure

320,00

Peso Neto 0,95 kg

Net Weight 0,95 kg

Equipada con cable eléctrico de 2 m (78.7")

Equipped with 2 m (78.7") of electric cable

Difusor C

Diffuser C

3351100C Estructura Blanca

White Structure

305,00

3351200C Estructura Negra

Black Structure

305,00

3351000C Estructura Oro

Gold Structure

345,00

Peso Neto 1,5 kg

Net Weight 1,5 kg

Equipada con cable eléctrico de 2 m (78.7")

Equipped with 2 m (78.7") of electric cable



Sin bombilla

Without bulb

E27 LED

E27 LED

25 W / 220-240 V / 50-60 Hz

25 W / 220-240 V / 50-60 Hz

MODELO

COD.

ACABADOS

FINISHES

EUROS

Mei Móvil

COLGANTE / SUSPENSION LAMP

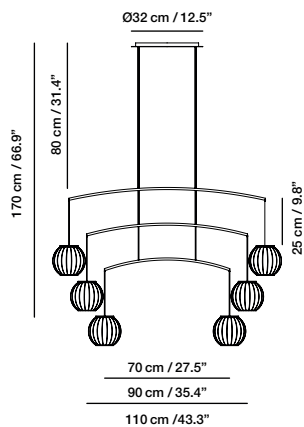
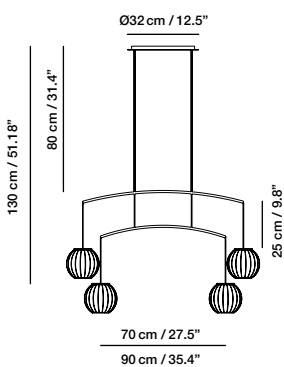
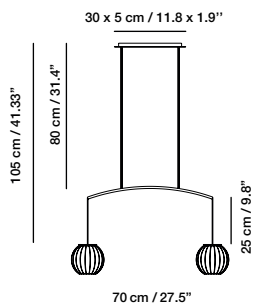

PANTALLAS / SHADES

Difusor A / Diffuser A

Difusor B / Diffuser B

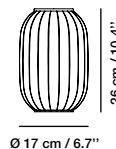

Difusor C / Diffuser C

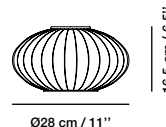

Estructura: metal
Difusor: porcelana

Structure: metal
Diffuser: porcelain

- 3371100** Estructura Blanca
- 3371200** Estructura Negra
- 3371000** Estructura Oro

- Mei móvil 2**
White Structure **300,00**
- Black Structure **300,00**
- Gold Structure **345,00**

- 3381100** Estructura Blanca
- 3381200** Estructura Negra
- 3381000** Estructura Oro

- Mei móvil 4**
White Structure **420,00**
- Black Structure **420,00**
- Gold Structure **750,00**

- 3391100** Estructura Blanca
- 3391200** Estructura Negra
- 3391000** Estructura Oro

- Mei móvil 6**
White Structure **595,00**
- Black Structure **595,00**
- Gold Structure **990,00**

PESO NETO

Mei 2 Estructura (1,61 kg)
Mei 4 Estructura (2 kg)
Mei 6 Estructura (2,51 kg)

NET WEIGHT

Mei 2 Structure (1,61 kg)
Mei 4 Structure (2 kg)
Mei 6 Structure (2,5 kg)

Equipada con cable eléctrico de 2 m (78.7")

Equipped with 2 m (78.7") of electric cable

Difusor de porcelana no incluido Porcelain diffuser not included

E27 LED

Mei 2
2 X 25 W / 220-240 V / 50-60 Hz
Mei 4
4 X 25 W / 220-240 V / 50-60 Hz
Mei 6
6 X 25 W / 220-240 V / 50-60 Hz

E27 LED

Mei 2
2 X 25 W / 220-240 V / 50-60 Hz
Mei 4
4 X 25 W / 220-240 V / 50-60 Hz
Mei 6
6 X 25 W / 220-240 V / 50-60 Hz

PANTALLAS

Difusor de porcelana:

- PAN1330** Difusor A
- PAN1331** Difusor B
- PAN1332** Difusor C

SHADES

Porcelain diffuser:

- Diffuser A** **140,00**
- Diffuser B** **175,00**
- Diffuser C** **185,00**

PESO NETO

Difusor A (0,65 kg)
Difusor B (0,95 kg)
Difusor C (1,5 kg)

NET WEIGHT

Diffuser A (0,65 kg)
Diffuser B (0,95 kg)
Diffuser C (1,5 kg)

Sin bombilla

Mei :Difusor A y B
E27 LED
Mei :Difusor C
E27 LED

Without bulb

Mei :Diffuser A and B
E27 LED
Mei :Diffuser C
E27 LED

MODELO COD. ACABADOS FINISHES EUROS

Melina

SOBREMESA / TABLE LAMP

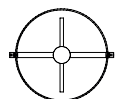

Ø 33 cm / 13"

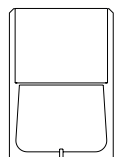

Ø 37 cm / 14.6"

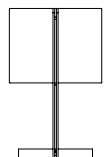

27 cm / 10.6"

26 cm / 10.2"
50 cm / 20.8"



Estructura: madera de roble

Structure: oak wood

Pantalla

5631000 Lino (beige)
5631110 Sagurán (Fibra natural)

Shades

Linen (beige)
Saguran (Natural fiber)

460,00
480,00

Equipado con tirador

Equipped with pull switch

Sin bombilla
E27 LED
100 W / 220-240 V / 50-60 Hz

Without bulb
E27 LED
100 W / 220-240 V / 50-60 Hz

Montoya

APLIQUE / WALL LAMP

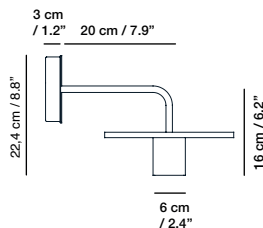

10 YEARS WARRANTY
ANTI-CORROSION ALUMINIUM

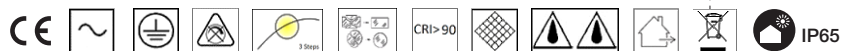

Estructura: metal
Difusor: cristal

Structure: metal
Diffuser: glass

1001020 Gris
1001022 Azul
1001024 Verde
1001046 Rojo

Grey
Blue
Green
Red

595,00
595,00
595,00
595,00

Sin interruptor

Without switch

LED INTEGRADO
6,6 W / 100-240 V / 50-60 Hz
704 Lumen / 2700 K / CRI 90

INTEGRATED LED
6,6 W / 100-240 V / 50-60 Hz
704 Lumen / 2700 K / CRI 90

Montoya

COLGANTE / SUSPENSION LAMP

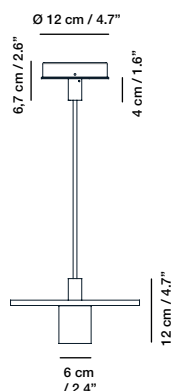

10 YEARS WARRANTY
ANTI-CORROSION ALUMINIUM

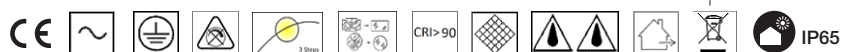

Estructura: metal
Difusor: cristal

Structure: metal
Diffuser: glass

1001021 Gris
1001023 Azul
1001025 Verde
1001047 Rojo

Grey
Blue
Green
Red

650,00
650,00
650,00
650,00

Sin interruptor

Without switch

LED INTEGRADO
6,6 W / 100-240 V / 50-60 Hz
704 Lumen / 2700 K / CRI 90

INTEGRATED LED
6,6 W / 100-240 V / 50-60 Hz
704 Lumen / 2700 K / CRI 90

MODELO

COD.

ACABADOS

FINISHES

EUROS

Neil

COLGANTE / SUSPENSION LAMP

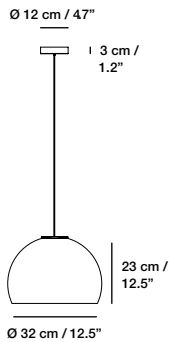
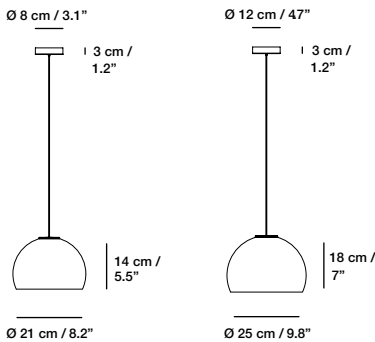
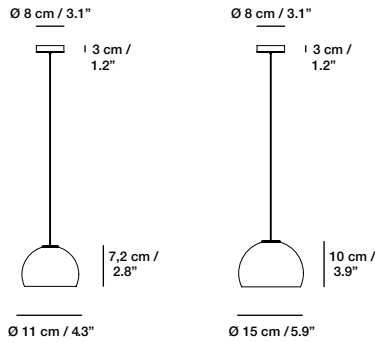

- 3271000
- 3271001
- 3021000
- 3021001
- 3031000
- 3031001
- 3221000
- 3221001
- 3231000
- 3231001

Alabastro

- Ø 11 cm / 4.3"
- Níquel mate
- Oro satinado
- Ø 15 cm / 5.9"
- Níquel mate
- Oro satinado
- Ø 21 cm / 8.2"
- Níquel mate
- Oro satinado
- Ø 25 cm / 9.8"
- Níquel mate
- Oro satinado
- Ø 32 cm / 12.5"
- Níquel mate
- Oro satinado

* Producto con vetas naturales aleatorias

PESO NETO

- Ø11 cm / 4.3" (0,68 kg)
- Ø 15 cm / 5.9" (1,22 kg)
- Ø 21 cm / 8.2" (2,42 kg)
- Ø 25 cm / 9.8" (4,82 kg)
- Ø 32 cm / 12.5" (8,32 kg)

Equipada con cable eléctrico de 2 m (78.7")

LED INTEGRADO

- Ø11 cm / 4.3"
- Ø 15 cm / 5.9"
- Ø 21 cm / 8.2"
- 7 W / 100-240 V / 50-60 Hz
- 704 Lumen / 2700 K / CRI 90
- Ø 25 cm / 9.8"
- Ø 32 cm / 12.5"
- 10 W / 220-240 V / 50-60 Hz
- 973 Lumen / 2700 K / CRI 90

Alabaster

- Ø11 cm / 4.3"
- Matt nickel
- Satin gold
- Ø 15 cm / 5.9"
- Matt nickel
- Satin gold
- Ø 21 cm / 8.2"
- Matt nickel
- Satin gold
- Ø 25 cm / 9.8"
- Matt nickel
- Satin gold
- Ø 32 cm / 12.5"
- Matt nickel
- Satin gold

* Product with random natural veins

NET WEIGHT

- Ø11 cm / 4.3" (0,68 kg)
- Ø 15 cm / 5.9" (1,22 kg)
- Ø 21 cm / 8.2" (2,42 kg)
- Ø 25 cm / 9.8" (4,82 kg)
- Ø 32 cm / 12.5" (8,32 kg)

Equipped with 2 m (78.7") of electric cable

INTEGRATED LED

- Ø11 cm / 4.3"
- Ø 15 cm / 5.9"
- Ø 21 cm / 8.2"
- 7 W / 100-240 V / 50-60 Hz
- 704 Lumen / 2700 K / CRI 90
- Ø 25 cm / 9.8"
- Ø 32 cm / 12.5"
- 10 W / 220-240 V / 50-60 Hz
- 973 Lumen / 2700 K / CRI 90

- 325,00
- 325,00
- 345,00
- 345,00
- 425,00
- 425,00
- 650,00
- 650,00
- 925,00
- 925,00

Para adaptar a Florón A / To adapt to Canopy A

Ver página 48 / See page 48

MODELO COD. ACABADOS FINISHES EUROS

Neil

COLGANTE / SUSPENSION LAMP

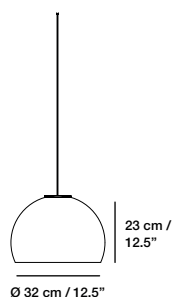
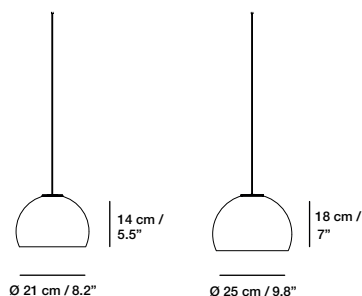
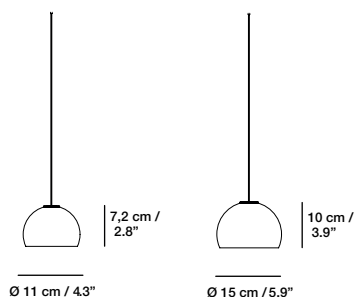

Alabastro

Alabaster

COD.	ACABADOS	FINISHES	EUROS
3271000C	Níquel mate	Matt nickel	325,00
3271001C	Oro satinado	Satin gold	325,00
	Ø 15 cm / 5.9"	Ø 15 cm / 5.9"	
3021000C	Níquel mate	Matt nickel	345,00
3021001C	Oro satinado	Satin gold	345,00
	Ø 21 cm / 8.2"	Ø 21 cm / 8.2"	
3031000C	Níquel mate	Matt nickel	425,00
3031001C	Oro satinado	Satin gold	425,00
	Ø 25 cm / 9.8"	Ø 25 cm / 9.8"	
3221000C	Níquel mate	Matt nickel	650,00
3221001C	Oro satinado	Satin gold	650,00
	Ø 32 cm / 12.5"	Ø 32 cm / 12.5"	
3231000C	Níquel mate	Matt nickel	925,00
3231001C	Oro satinado	Satin gold	925,00

* Producto con vetas naturales aleatorias

* Product with random natural veins

PESO NETO

Ø11 cm / 4.3" (0,58 kg)
 Ø 15 cm / 5.9" (1,12 kg)
 Ø 21 cm / 8.2" (2,32 kg)
 Ø 25 cm / 9.8" (4,72 kg)
 Ø 32 cm / 12.5" (8,22 kg)

NET WEIGHT

Ø11 cm / 4.3" (0,58 kg)
 Ø 15 cm / 5.9" (1,12 kg)
 Ø 21 cm / 8.2" (2,32 kg)
 Ø 25 cm / 9.8" (4,72 kg)
 Ø 32 cm / 12.5" (8,22 kg)

Equipada con cable eléctrico de 2 m (78.7")

Equipped with 2 m (78.7") of electric cable

LED INTEGRADO

-Ø11 cm / 4.3", Ø 15 cm / 5.9",
 Ø 21 cm / 8.2":
 7 W / 100-240 V / 50-60 Hz
 704 Lumen / 2700 K / CRI 90
 -Ø 25 cm / 9.8", Ø 32 cm / 12.5":
 10 W / 220-240 V / 50-60 Hz
 973 Lumen / 2700 K / CRI 90

INTEGRATED LED

-Ø11 cm / 4.3", Ø 15 cm / 5.9",
 Ø 21 cm / 8.2":
 7 W / 100-240 V / 50-60 Hz
 704 Lumen / 2700 K / CRI 90
 -Ø 25 cm / 9.8", Ø 32 cm / 12.5":
 10 W / 220-240 V / 50-60 Hz
 973 Lumen / 2700 K / CRI 90

MODELO COD. ACABADOS FINISHES EUROS

Nirvana

LAMPARA DE PIE / FLOOR LAMP

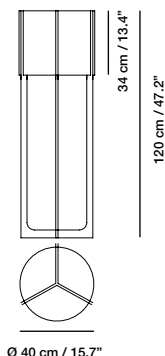

Estructura: metal

Structure: metal

5711000	Níquel mate + Pantalla blanca	Matt nickel + White shade	885,00
5711014	Níquel mate + Pant. gris metalizado	Matt nickel + Metal grey shade	925,00
5711110	Blanco + Pantalla blanca	White + White shade	620,00
5711214	Negro + Pantalla gris metalizado	Black + Metal grey shade	670,00

Equipado con tirador

Equipped with pull switch



Sin bombilla

Without bulb

E27 LED

E27 LED

100 W / 220-240 V / 50-60 Hz

100 W / 220-240 V / 50-60 Hz

Nirvana

SOBREMESA / TABLE LAMP

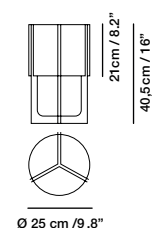

Ø 25 cm / 9.8"

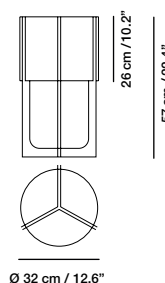

Ø 32 cm / 12.6"

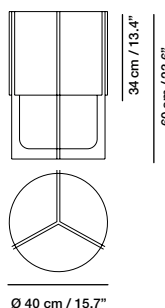

Ø 40 cm / 15.7"



Estructura: metal

Structure: metal

5731000	Níquel mate + Pantalla blanca	Matt nickel + White shade	475,00
5731014	Níquel mate + Pant. gris metalizado	Matt nickel + Metal grey shade	499,00
5731110	Blanco + Pantalla blanca	White + White shade	400,00
5731214	Negro + Pantalla gris metalizado	Black + Metal grey shade	425,00
	Ø 25 cm / 9.8"	Ø 25 cm / 9.8"	
5641000	Níquel mate + Pantalla blanca	Matt nickel + White shade	575,00
5641014	Níquel mate + Pant. gris metalizado	Matt nickel + Metal grey shade	615,00
5641110	Blanco + Pantalla blanca	White + White shade	475,00
5641214	Negro + Pantalla gris metalizado	Black + Metal grey shade	500,00
	Ø 32 cm / 12.6"	Ø 32 cm / 12.6"	
5721000	Níquel mate + Pantalla blanca	Matt nickel + White shade	660,00
5721014	Níquel mate + Pant. gris metalizado	Matt nickel + Metal grey shade	680,00
5721110	Blanco + Pantalla blanca	White + White shade	546,00
5721214	Negro + Pantalla gris metalizado	Black + Metal grey shade	580,00

Equipada con tirador

Equipped with pull switch



Sin bombilla

Without bulb

E27 LED

E27 LED

100 W / 220-240 V / 50-60 Hz

100 W / 220-240 V / 50-60 Hz

MODELO COD. ACABADOS FINISHES EUROS

Nura

COLGANTE / SUSPENSION LAMP



Estructura: metal

Structure: metal

Nura 1

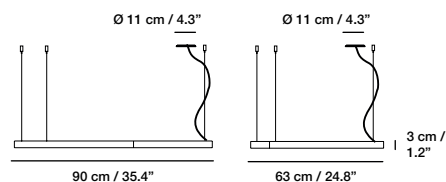

2201100
2161100

Blanco

Nura 1
Nura 2

White

Nura 1
Nura 2

865,00
2.470,00

Níquel negro brillante

Nura 1
Nura 2

Bright black nickel

Nura 1
Nura 2

1.420,00
4.100,00

Equipada con cable eléctrico de 3 m (118,11")

Equipped with 3 m (118,11") of electric cable

LED INTEGRADO

- Nura 1:
40 W / 100-240 V / 50-60 Hz
4600 Lumen / 2700 K / CRI 80
- Nura 2:
85 W / 100-240 V / 50-60 Hz
10510 Lumen / 2700 K / CRI 80

INTEGRATED LED

- Nura 1:
40 W / 100-240 V / 50-60 Hz
4600 Lumen / 2700 K / CRI 80
- Nura 2:
85 W / 100-240 V / 50-60 Hz
10510 Lumen / 2700 K / CRI 80

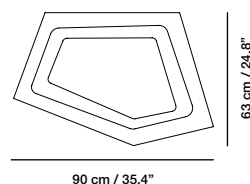

Nura 2

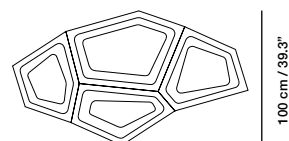
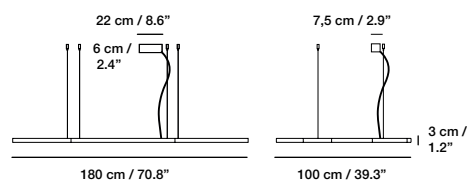

Nura

APLIQUE-PLAFÓN / WALL-CEILING LAMP



Estructura: metal

Structure: metal

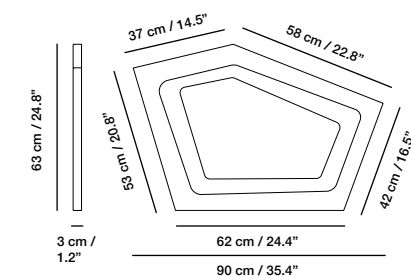

2151100
2151000

Blanco

Pan de oro

White

Gold leaf

600,00
920,00

Uso individual o modular

Luz indirecta
Sin interruptor

Individual or modular use

Indirect lighting
Without switch

LED INTEGRADO

30 W / 100-240 V / 50-60 Hz
2900 Lumen / 2700 K / CRI 80

INTEGRATED LED

30 W / 100-240 V / 50-60 Hz
2900 Lumen / 2700 K / CRI 80

MODELO COD. ACABADOS FINISHES EUROS

Oliver

APLIQUE-PLAFÓN / WALL-CEILING LAMP

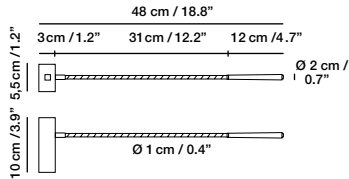

Flexión máxima 90° /
Maximum flexion 90°



Estructura: metal

Structure: metal

6711100 Blanco
6711001 Cromo
6711000 Níquel mate
6711200 Negro

White
Chrome
Matt nickel
Black

245,00
245,00
245,00
245,00

Interruptor en la base

Switch on the base

LED INTEGRADO
2 W / 100-240 V / 50-60 Hz
100 Lumen / 3000 K / CRI 80
Color cálido
Ángulo de apertura 50°

INTEGRATED LED
2 W / 100-240 V / 50-60 Hz
100 Lumen / 3000 K / CRI 80
Warm colour
50° lighting angle

Parme

APLIQUE / WALL LAMP

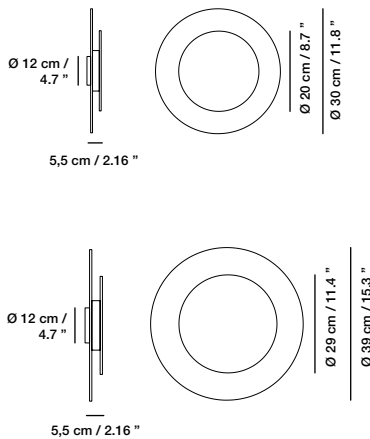

Estructura metálica formada por
discos superpuestos

Metal structure made of
overlapping discs

1151000 Oro
1151020 Blanco

1151100 Oro
1151120 Blanco

Ø 30 cm / 11.8"
Oro
Blanco

Ø 39 cm / 15.3"
Oro
Blanco

Ø 30 cm / 11.8"
Gold
White

Ø 39 cm / 15.3"
Gold
White

390,00
350,00

415,00
390,00

Sin interruptor

Without switch

LED INTEGRADO
15 W / 100-240 V / 50-60 Hz
2 x 704 Lumen / 2700 K / CRI 90

INTEGRATED LED
15 W / 100-240 V / 50-60 Hz
2 x 704 Lumen / 2700 K / CRI 90

Pedra

APLIQUE / WALL LAMP

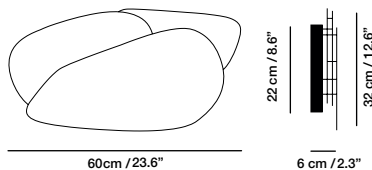

Estructura metálica formada por
lamas superpuestas

Metal structure made of
overlapping slats

6841100 Blanco
6841200 Oro

White
Gold

White
Gold

450,00
485,00

Sin interruptor

Without switch

LED INTEGRADO
25 W / 100-240 V / 50-60 Hz
2290 Lumen / 2700 K / CRI 80

INTEGRATED LED
25 W / 100-240 V / 50-60 Hz
2290 Lumen / 2700 K / CRI 80

MODELO COD. ACABADOS FINISHES EUROS

Pippet

COLGANTE / SUSPENSION LAMP

Peso neto / Net weight
0,29 kg

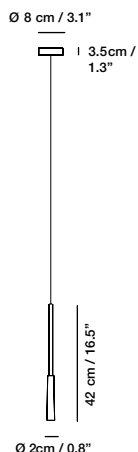

Estructura: metal

Structure: metal

COD.	ACABADOS	FINISHES	EUROS
2011100	Blanco	White	240,00
2011001	Níquel mate	Matt nickel	250,00
2011200	Negro	Black	240,00
2011002	Oro	Gold	275,00
2011003	Níquel negro brillante	Bright black nickel	285,00
2011004	Azul gris metalizado	Metallic blue grey	285,00
2011005	Turquesa metalizado	Metallic turquoise	285,00
2011006	Rojo metalizado	Metallic Red	285,00

Equipada con cable eléctrico de 2 m (78.7")

Equipped with 2 m (78.7") of electric cable

LED INTEGRADO

INTEGRATED LED

2 W / 100-240 V / 50-60 Hz
100 Lumen / 3000 K / CRI 80

2 W / 100-240 V / 50-60 Hz
100 Lumen / 3000 K / CRI 80

Para adaptar a Florón B / To adapt to Canopy B

Ver página 49 / See page 49

Pippet

COLGANTE / SUSPENSION LAMP

Peso neto / Net weight
0,19 kg

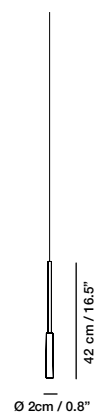

Estructura: metal

Structure: metal

COD.	ACABADOS	FINISHES	EUROS
2011100C	Blanco	White	240,00
2011001C	Níquel mate	Matt nickel	250,00
2011200C	Negro	Black	240,00
2011002C	Oro	Gold	275,00
2011003C	Níquel negro brillante	Bright black nickel	285,00
2011004C	Azul gris metalizado	Metallic blue grey	285,00
2011005C	Turquesa metalizado	Metallic turquoise	285,00
2011006C	Rojo metalizado	Metallic Red	285,00

Equipada con cable eléctrico de 2 m (78.7")

Equipped with 2 m (78.7") of electric cable

LED INTEGRADO

INTEGRATED LED

2 W / 100-240 V / 50-60 Hz
100 Lumen / 3000 K / CRI 80

2 W / 100-240 V / 50-60 Hz
100 Lumen / 3000 K / CRI 80



MODELO

COD.

ACABADOS

FINISHES

EUROS

Punt

APLIQUE-PLAFÓN / WALL-CEILING LAMP



CON INTERRUPTOR / WITH SWITCH

Estructura: fundición de aluminio inyectado

Structure: Die cast injected aluminum

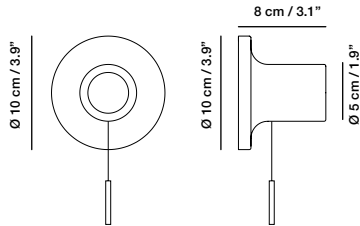

- 2141100**
- 2141300**
- 2141400**
- 2141200**

Con tirador
 Blanco
 Oro satinado
 Terracota
 Negro

With pull switch
 White
 Satin gold
 Terracotta
 Black

- 165,00**
- 170,00**
- 165,00**
- 165,00**

SIN INTERRUPTOR / WITHOUT SWITCH

Sin tirador
 Blanco
 Oro satinado
 Terracota
 Negro

Without pull switch
 White
 Satin gold
 Terracotta
 Black

- 140,00**
- 155,00**
- 140,00**
- 140,00**

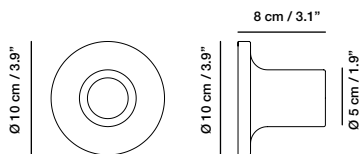

Sin bombilla
 E27 LED
 100 W / 220-240 V / 50-60 Hz

Without bulb
 E27 LED
 100 W / 220-240 V / 50-60 Hz

Quadrat

APLIQUE / WALL LAMP



Estructura: Fundición de aluminio

Structure: Die cast aluminum

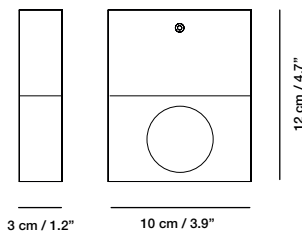

- 6901000**
- 6901100**
- 6901200**
- 6901001**

Níquel mate
 Blanco
 Negro
 Oro

Matt nickel
 White
 Black
 Gold

- 300,00**
- 285,00**
- 285,00**
- 300,00**

Giratorio
 Sin interruptor

Turnable
 Without switch

LED INTEGRADO
 6 W / 220-240 V / 50-60 Hz
 690 Lumen / 3000 K / CRI 80
 Ángulo de apertura 120°

INTEGRATED LED
 6 W / 220-240 V / 50-60 Hz
 690 Lumen / 3000 K / CRI 80
 120° lighting angle



MODELO

COD.

ACABADOS

FINISHES

EUROS

Rebound

COLGANTE / SUSPENSION LAMP

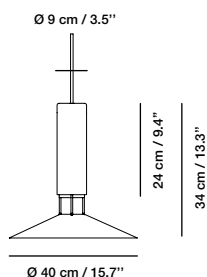

Estructura: Mármol
Difusor: Latón y cuero

Structure: Marble
Diffuser: Brass and leather

Con cuero

With leather

Cuero marrón

Brown leather

1003004

Travertino

Travertine

1.560,00

Cuero negro

Black leather

1003001

Mármol de carrara

Carrara marble

1.380,00

1003002

Mármol negro

Black marble

1.380,00

1003003

Mármol verde

Green marble

1.270,00

Sin cuero

Without leather

1003005

Mármol de carrara

Carrara marble

1.150,00

1003006

Mármol negro

Black marble

1.150,00

1003007

Mármol verde

Green marble

1.050,00

1003008

Travertino

Travertine

1.260,00

Peso Neto 5,85 kg

Net Weight 5,85 kg



Bombilla GU10 LED incluida
9 W / 220-240 V / 50-60 Hz
880 Lumen / 3000 K / CRI 80

GU10 LED bulb included
9 W / 220-240 V / 50-60 Hz
880 Lumen / 3000 K / CRI 80

Rebound

SOBREMESA / TABLE LAMP

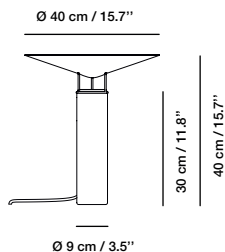

Estructura: Piedra
Difusor: Latón y cuero

Structure: Stone
Diffuser: Brass and leather

Con cuero

With leather

Cuero marrón

Brown leather

1003012

Travertino

Travertine

1.560,00

Cuero negro

Black leather

1003009

Mármol de carrara

Carrara marble

1.390,00

1003010

Mármol negro

Black marble

1.390,00

1003011

Mármol verde

Green marble

1.270,00

Sin cuero

Without leather

1003013

Mármol de carrara

Carrara marble

1.150,00

1003014

Mármol negro

Black marble

1.150,00

1003015

Mármol verde

Green marble

1.050,00

1003016

Travertino

Travertine

1.260,00

Peso Neto 6,85 kg

Net Weight 6,85 kg



Equipada con interruptor
Bombilla GU10 LED incluida
9 W / 220-240 V / 50-60 Hz
880 Lumen / 3000 K / CRI 80

Equipped with switch
GU10 LED bulb included
9 W / 220-240 V / 50-60 Hz
880 Lumen / 3000 K / CRI 80

MODELO

COD.

ACABADOS

FINISHES

EUROS

Robin

LAMPARA DE PIE / FLOOR LAMP

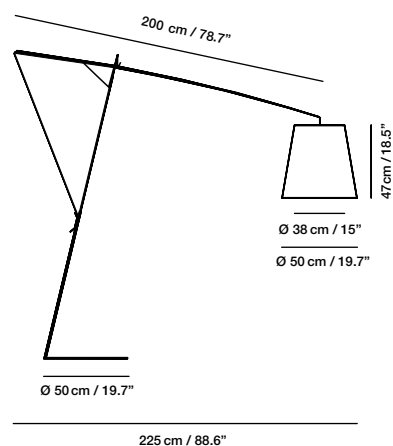

- 6281001
- 6281003
- 6281010
- 6281011
- 6281110



Estructura: metal
 Brazo: fibra de carbono flexible
 Pantalla: algodón o policarbonato

Structure: Metal
 Arm: flexible black fiber
 Shade: cotton or polycarbonate

Estructura negra

- Pantalla algodón blanca
- Pantalla algodón beige
- Pantalla policarbonato blanca
- Pantalla policarbonato beige

Black structure

- White cotton shade
- Beige cotton shade
- White polycarbonate shade
- Beige polycarbonate shade

- 720,00
- 720,00
- 720,00
- 720,00

Estructura blanca

- Pantalla policarbonato blanca

White structure

- White polycarbonate shade

- 720,00

Otros colores pantalla consultar

Other shade colours upon request

Altura regulable
 Interruptor en el portalámparas
 Equipada con cable eléctrico de 8 m (315")

Height adjustable
 Switch on the lampholder
 Equipped with 8 m (315") of electric cable

PESO BASE 13,6 kg

BASE WEIGHT 13,6 kg



Sin bombilla
 E27 LED
 150 W / 220-240 V / 50-60 Hz

Without bulb
 E27 LED
 150 W / 220-240 V / 50-60 Hz

Robinson

COLGANTE / SUSPENSION LAMP

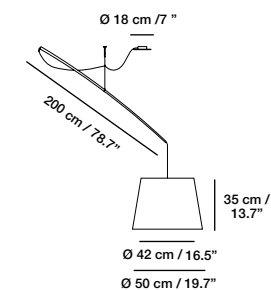

- 1681010
- 1681011



Estructura: Negra
 Brazo: fibra de carbono flexible
 Pantalla: algodón

Structure: Black
 Arm: flexible black fiber
 Shade: cotton

Ø 50 cm / 19.7"

- Pantalla blanca
- Pantalla beige

Ø 50 cm / 19.7"

- White shade
- Beige shade

- 445,00
- 445,00

Ø 64 cm / 25.2"

- Pantalla blanca
- Pantalla beige

Ø 64 cm / 25.2"

- White shade
- Beige shade

- 465,00
- 465,00

Otros colores pantalla consultar

Other shade colours upon request

Ø 64 cm / 25.2": Equipada con cable eléctrico 3,5 m (138")
Ø 50 cm / 19.7": Equipada con cable eléctrico 3,5 m (138")

Ø 64 cm / 25.2": Equipped with 3,5 m (138") of electric cable
Ø 50 cm / 19.7": Equipped with 3,5 m (138") of electric cable

Móvil, gira en sentido circular 360° y basculante
 Altura regulable
 Interruptor en el portalámparas

Mobile with a turn of 360° and tilting
 Height adjustable
 Switch on the lampholder

Sin bombilla
 E27 LED
 150 W / 220-240 V / 50-60 Hz

Without bulb
 E27 LED
 150 W / 220-240 V / 50-60 Hz

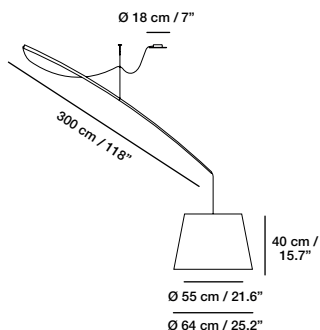



MODELO COD. ACABADOS FINISHES EUROS

Sasha

IN / OUTDOOR

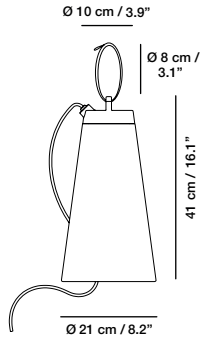
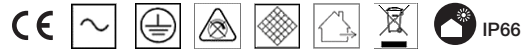

6721100

Asa: aluminio lacado blanco
Pantalla: polietileno blanco
Brida: silicona transparente

Handle: aluminum painted in white
Shade: white polyethylene
Strap: transparent silicone

245,00

Otros colores bajo consulta
Se puede colocar en el suelo o como colgante
Equipada con cable 7 m (275,6")

Other colours upon request
To be used as floor or suspension lamp
Equipped with 7 m (275,6") of cable



Bombilla incluida
E27 LED
11 W / 220-240 V / 50-60 Hz
1055 Lumen / 3000 K

Bulb included
E27 LED
11 W / 220-240 V / 50-60 Hz
1055 Lumen / 3000 K

Sasha_battery

SOBREMESA / TABLE LAMP

IN / OUTDOOR

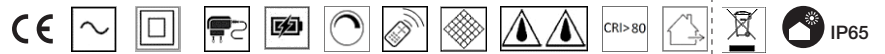

PEQUEÑA / SMALL

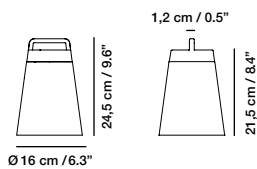

3061000

3061500

3061700

Asa: aluminio lacado
Pantalla: polietileno blanco
Brida: silicona transparente

Handle: painted aluminum
Shade: white polyethylene
Strap: transparent silicone

Pequeña

Blanco
Rojo vino
Verde oliva

Small

White
Red wine
Green olive

295,00

300,00

300,00

Grande

3051000

3051500

3051700

Blanco
Rojo vino
Verde oliva

Large

White
Red wine
Green olive

315,00

325,00

325,00

GRANDE / LARGE

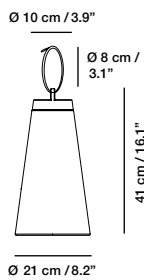

Otros colores bajo consulta
Regulable con interruptor
Mando a distancia incluido

Other colours upon request
Dimmer switch
Remote control included



LED INTEGRADO
3,3 W / 100-240 V / 50-60 Hz
500 Lumen / 3000 K / CRI 80

INTEGRATED LED
3,3 W / 100-240 V / 50-60 Hz
500 Lumen / 3000 K / CRI 80

ACCESORIOS / ACCESSORIES

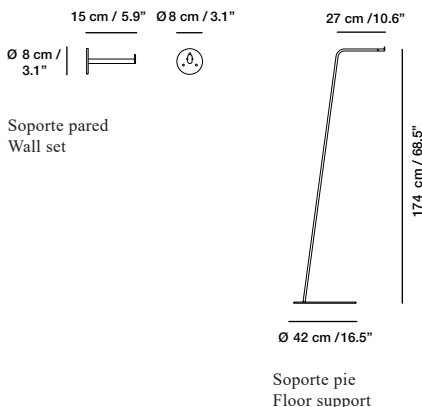

Soporte pared
Wall set

Soporte pie
Floor support

Funcionamiento por batería
Recarga por USB
Batería: autonomía de 8h aprox.

Battery operation
Recharging by USB
Battery: autonomy of 8h approx.

ACCESORIOS

Compatibles con sasha, sasha battery.

Metal pintado blanco:
Soporte pared
Soporte pie

ACC1007

ACC1008

Otros colores bajo consulta

ACCESSORIES

Compatible with Sasha, Sasha battery.

Painted white metal:
Wall set
Floor support

78,00

340,00

Other colours upon request

MODELO COD. ACABADOS FINISHES EUROS

Sky

APLIQUE-PLAFÓN / WALL-CEILING LAMP

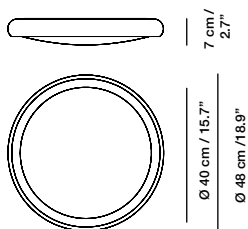

Estructura: metal
Cristal opal blanco

Structure: metal
White opal glass

2391110	Exterior blanco + Interior blanco	Outside white + Inside white	495,00
2391111	Exterior blanco + Interior oro	Outside white + Inside gold	495,00
2391210	Exterior negro + Interior blanco	Outside black + Inside white	495,00
2391211	Exterior negro + Interior oro	Outside black + Inside gold	495,00

Sin interruptor

Without switch

LED INTEGRADO
20 W / 220-240 V / 50-60 Hz
3110 Lumen / 3000 K / CRI 80

INTEGRATED LED
20 W / 220-240 V / 50-60 Hz
3110 Lumen / 3000 K / CRI 80

Snaik

APLIQUE / WALL LAMP

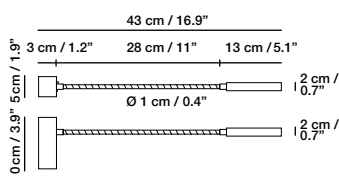

Flexión máxima 90° /
Maximum flexion 90°



Estructura: metal

Structure: metal

1381001	Cromo	Chrome	265,00
1381000	Níquel mate	Matt nickel	265,00
1381100	Blanco	White	255,00
1381200	Negro	Black	255,00

Equipada con interruptor

Equipped with switch

LED INTEGRADO
3,2 W / 100-240 V / 50-60 Hz
420 Lumen / 2700 K / CRI 80
Apertura de ángulo 120°

INTEGRATED LED
3,2 W / 100-240 V / 50-60 Hz
420 Lumen / 2700 K / CRI 80
120° lighting angle

Sputnik

LAMPARA DE PIE / FLOOR LAMP

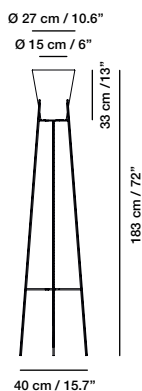

Estructura: metal lacado

Structure: lacquered metal

3081100	Blanco	White	895,00
3081001	Oro	Gold	895,00
3081200	Negro	Black	895,00
3081008	Níquel negro	Black nickel	895,00

Doble encendido: superior e inferior / Equipado con regulador de intensidad

Double lighting: upper and lower / Equipped with dimmer

LED INTEGRADO
- Superior:
32 W / 220-240 V / 50-60 Hz
3110 Lumen / 3000 K / CRI 80
- Inferior:
20 W / 220-240 V / 50-60 Hz
2300 Lumen / 2700 K / CRI 80

INTEGRATED LED
- Upper:
32 W / 220-240 V / 50-60 Hz
3110 Lumen / 3000 K / CRI 80
- Lower:
20 W / 220-240 V / 50-60 Hz
2300 Lumen / 2700 K / CRI 80



MODELO

COD.

ACABADOS

FINISHES

EUROS

Tema

LAMPARA DE PIE / FLOOR LAMP

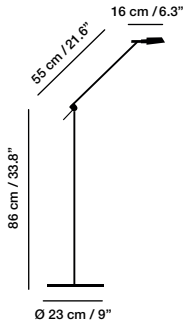

Estructura: metal

Structure: metal

7431011
7431012
7431100
7431200
2161103

Níquel mate
Oro satinado
Blanco
Negro
Níquel negro brillante

Matt nickel
Satin gold
White
Black
Bright black nickel

560,00
580,00
450,00
450,00
780,00

Lámpara articulada
Brazo abatible y cabezal orientable
Equipada con interruptor

Joined lamp
Folding arm & swivel head
Equipped with switch

LED INTEGRADO
7 W / 120-240 V / 50-60 Hz
704 Lumen / 2700 K / CRI 90
Ángulo de apertura 120°

INTEGRATED LED
67 W / 120-240 V / 50-60 Hz
704 Lumen / 2700 K / CRI 90
120° lighting angle

Tema

SOBREMESA / TABLE LAMP

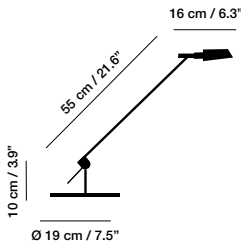

Estructura: metal

Structure: metal

7421011
7421012
7421100
7421200
2161104

Níquel mate
Oro satinado
Blanco
Negro
Níquel negro brillante

Matt nickel
Satin gold
White
Black
Bright black nickel

450,00
470,00
420,00
420,00
680,00

Lámpara articulada
Brazo abatible y cabezal orientable
Equipada con interruptor

Joined lamp
Folding arm & swivel head
Equipped with switch

LED INTEGRADO
7 W / 120-240 V / 50-60 Hz
704 Lumen / 2700 K / CRI 90
Ángulo de apertura 120°

INTEGRATED LED
7 W / 120-240 V / 50-60 Hz
704 Lumen / 2700 K / CRI 90
120° lighting angle

Tiffany 2

IN / OUTDOOR

LAMPARA DE PIE / FLOOR LAMP

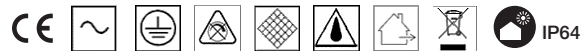
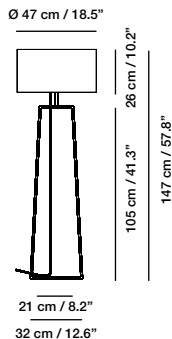

Estructura metálica
Pantalla en polietileno blanco

Metallic structure
Lampshade: white polyethylene

2101100
2101200

Base pie
Blanco
Negro

Foot base
White
Black

920,00
920,00

Equipada con cable 7 m (275,6")

Equipped with 7 m (275,6") of cable



Bombilla incluida
E27 LED
11 W / 220-240 V / 50-60 Hz
1055 Lumen / 3000 K

Bulb included
E27 LED
11 W / 220-240 V / 50-60 Hz
1055 Lumen / 3000 K

MODELO

COD.

ACABADOS

FINISHES

EUROS

Totora

LAMPARA DE PIE / FLOOR LAMP

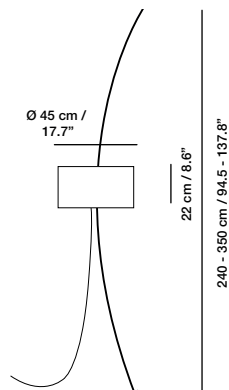

Estructura negra	Black structure
Pantalla: algodón	Shade: cotton
Barra: fibra de carbono flexible	Stem: flexible black fiber
Altura regulable	Height adjustable
Interruptor en el portalámparas	Switch on the lampholder

Pantalla

5991004	Blanco
5991001	Beige
5991002	Roja
5991088	Sagurán

Shade

White	430,00
Beige	430,00
Red	430,00
Saguran	450,00

Sin bombilla	Without bulb
2 x E27 LED	2 x E27 LED
100 W / 220-240 V / 50-60 Hz	100 W / 220-240 V / 50-60 Hz

MODELO COD. ACABADOS FINISHES EUROS

Triana 1

COLGANTE / SUSPENSION LAMP

Individual / Single
Peso neto / Net weight
0,82 kg



Estructura: metal

Cable negro

- 1411000 Níquel - Níquel
- 1411001 Oro - Oro
- 1411110 Blanco - Blanco
- 1411120 Blanco - Oro
- 1411130 Blanco - Níquel
- 1411200 Negro - Negro
- 1411210 Negro - Oro
- 1411220 Negro - Níquel

Structure: metal

Black cable

- Matt nickel - Matt nickel **230,00**
- Satin gold - Satin gold **230,00**
- White - White **220,00**
- White - Satin gold **225,00**
- White - Matt nickel **225,00**
- Black - Black **220,00**
- Black - Satin gold **220,00**
- Black - Matt nickel **225,00**

Estructura: metal

Cable Blanco

- 1411021 Níquel - Níquel
- 1411081 Oro - Oro
- 1411111 Blanco - Blanco
- 1411121 Blanco - Oro
- 1411131 Blanco - Níquel
- 1411132 Blanco - Roble natural

Structure: metal

White cable

- Matt nickel - Matt nickel **225,00**
- Satin gold - Satin gold **225,00**
- White - White **210,00**
- White - Satin gold **235,00**
- White - Matt nickel **220,00**
- White - Natural oak **260,00**

Equipada con cable eléctrico de 2 m (78.7")

Equipped with 2 m (78.7") of electric cable



Bombilla incluida

GU10 LED
10 W / 220-240 V / 50-60 Hz
900 Lumen / 3000 K

Bulb included

GU10 LED
10 W / 220-240 V / 50-60 Hz
900 Lumen / 3000 K

Triana Accessories

COLGANTE / SUSPENSION LAMP

Doble / Double
Peso neto / Net weight:
2,13 kg

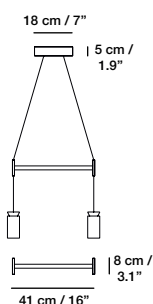

Triple / Triple
Peso neto / Net weight:
3,34 kg

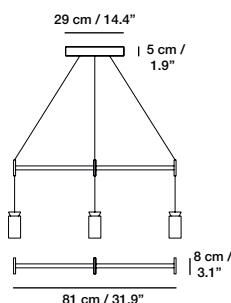

Para adaptar a Triana 1 /
To adapt to Triana 1

Ver arriba / See above



Estructura: metal

ACCESORIOS NEGRO

- ACC1003 Accesorio doble
- ACC1004 Accesorio triple
- ACC1005 Accesorio triple circular

Structure: metal

ACCESSORIES BLACK

- Double accessory **120,00**
- Triple accessory **160,00**
- Triple accessory circular **180,00**

ACCESORIOS NÍQUEL

- ACC1073 Accesorio doble
- ACC1074 Accesorio triple
- ACC1075 Accesorio triple circular

ACCESSORIES NICKEL

- Double accessory **115,00**
- Triple accessory **145,00**
- Triple accessory circular **180,00**

ACCESORIOS BLANCO

- ACC1083 Accesorio doble
- ACC1084 Accesorio triple
- ACC1085 Accesorio triple circular

ACCESSORIES WHITE

- Double accessory **115,00**
- Triple accessory **145,00**
- Triple accessory circular **175,00**

ACCESORIOS ORO

Ver página 42

ACCESORIOS ORO

See page 42

MODELO

COD.

ACABADOS

FINISHES

EUROS

Triana Accessories

COLGANTE / SUSPENSION LAMP

Para adaptar a Triana 1 /
To adapt to Triana 1

Ver página 42 / See page 42

Triple circular / Triple circular

Peso neto / Net weight:
3,12 kg

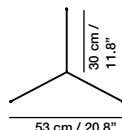
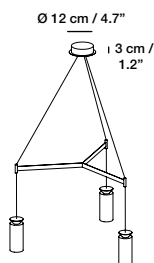

ACC1035	Accesorio doble
ACC1036	Accesorio triple
ACC1037	Accesorio triple circular

ACCESORIOS ORO	Double accessory	115,00
ACCESORIOS GOLD	Triple accessory	145,00
	Triple accessory circular	180,00

PESO NETO

Accesorio doble (0,28 kg)
Accesorio triple (0,54 kg)
Accesorio triple circular (0,61 kg)

NET WEIGHT

Double accessory (0,28 kg)
Triple accessory (0,54 kg)
Triple accessory circular (0,61 kg)

*Las lámparas se venden por separado (**ver página 39**) para elegir los acabados.

*The lamps are sold separately (**see page 39**) to choose the finishes.

Equipada con cable eléctrico de 2 m (78.7")

Equipped with 2 m (78.7") of electric cable



Bombilla incluida
GU10 LED
10 W / 220-240 V / 50-60 Hz
900 Lumen / 3000 K

Bulb included
GU10 LED
10 W / 220-240 V / 50-60 Hz
900 Lumen / 3000 K

Triana 2

COLGANTE / SUSPENSION LAMP

Individual sin florón / Single without canopy

Peso neto / Net weight
0,75 kg

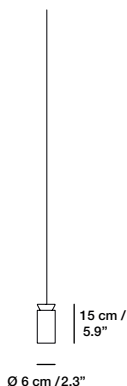

Para adaptar a Florón B /
To adapt to Canopy B

Ver página 49 / See page 49



	Cable negro
1411000C	Níquel - Níquel
1411001C	Oro - Oro
1411110C	Blanco - Blanco
1411120C	Blanco - Oro
1411130C	Blanco - Níquel
1411200C	Negro - Negro
1411210C	Negro - Oro
1411220C	Negro - Níquel

	Black cable
	Matt nickel - Matt nickel
	Satin gold - Satin gold
	White - White
	White - Satin gold
	White - Matt nickel
	Black - Black
	Black - Satin gold
	Black - Matt nickel

230,00
230,00
220,00
225,00
225,00
220,00
220,00
225,00

	Cable Blanco
1411021C	Níquel - Níquel
1411081C	Oro - Oro
1411111C	Blanco - Blanco
1411121C	Blanco - Oro
1411131C	Blanco - Níquel
1411132C	Blanco - Roble natural

	White cable
	Matt nickel - Matt nickel
	Satin gold - Satin gold
	White - White
	White - Satin gold
	White - Matt nickel
	White - Natural oak

225,00
225,00
210,00
235,00
220,00
260,00

Equipada con cable eléctrico de 2 m (78.7")

Equipped with 2 m (78.7") of electric cable



Bombilla incluida
GU10 LED
10 W / 220-240 V / 50-60 Hz
900 Lumen / 3000 K

Bulb included
GU10 LED
10 W / 220-240 V / 50-60 Hz
900 Lumen / 3000 K

MODELO COD. ACABADOS FINISHES EUROS

Triana Canopy

COLGANTE / SUSPENSION LAMP



Florón circular A3 /
Circular canopy A3

Ø 35 cm / 13.78"

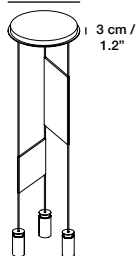

Florón rectangular B3 /
Rectangular canopy B3

Ø 60 cm / 23.6"

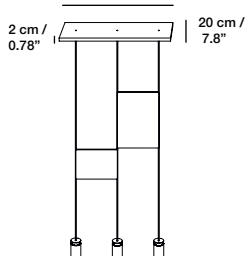

ACC2001
ACC2007
ACC2013
ACC2019

Florón A3 - Ø 35 cm / 14,17"
Apto para 3 Colgantes

Blanco
Negro
Oro
Níquel

Canopy A3 - Ø 35 cm / 14,17"
Suitable for 3 Pendant lamps

White
Black
Oro
Nickel

310,00
310,00
310,00
310,00

Florón rectangular B3
Apto para 3 Colgantes

ACC1019
ACC1020
ACC1041
ACC1021

Blanco
Negro
Oro
Níquel

Rectangular canopy B3
Suitable for 3 Pendant lamps

White
Black
Oro
Nickel

230,00
230,00
230,00
230,00

Florón rectangular B4 / Rectangular canopy B4

Ø 89 cm / 35"

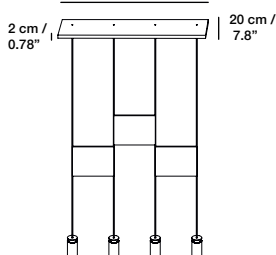

ACC1022
ACC1023
ACC1042
ACC1024

Florón rectangular B4
Apto para 4 Colgantes

Blanco
Negro
Oro
Níquel

Rectangular canopy B4
Suitable for 4 Pendant lamps

White
Black
Oro
Nickel

270,00
270,00
270,00
270,00

Florón zig-zag C4 / Canopy zig-zag C4

Ø 89 cm / 35"

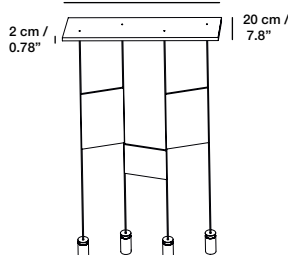

ACC1025
ACC1026
ACC1043
ACC1027

Florón zig-zag C4
Apto para 4 Colgantes

Blanco
Negro
Oro
Níquel

Zig-zag canopy C4
Suitable for 4 Pendant lamps

White
Black
Oro
Nickel

285,00
285,00
285,00
285,00

Paneles de madera / Wood panels

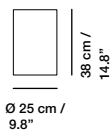
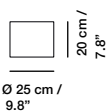

ACC1028
ACC1029
ACC1030

ACC1031
ACC1032
ACC1033

Paneles de madera

20cm / 8,66"

Madera de roble natural
Madera blanca
Madera negra

38cm / 15"

Madera de roble
Madera blanca
Madera negra

Wood Panels

20cm / 8,66"

Natural oak wood
White wood
Black wood

38cm / 15"

Natural oak wood
White wood
Black wood

99,00
99,00
99,00

145,00
145,00
145,00

*Las lámparas se venden por separado (**ver página 39**) para elegir los acabados.

Equipada con cable eléctrico de 2 m (78.7")

Bombilla incluida

GU10 LED
10 W / 220-240 V / 50-60 Hz
900 Lumen / 3000 K



*The lamps are sold separately (**see page 39**) to choose the finishes.

Equipped with 2 m (78.7") of electric cable

Bulb included

GU10 LED
10 W / 220-240 V / 50-60 Hz
900 Lumen / 3000 K

MODELO

COD.

ACABADOS

FINISHES

EUROS

Tripod

LAMPARA DE PIE / FLOOR LAMP

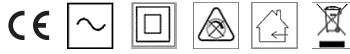
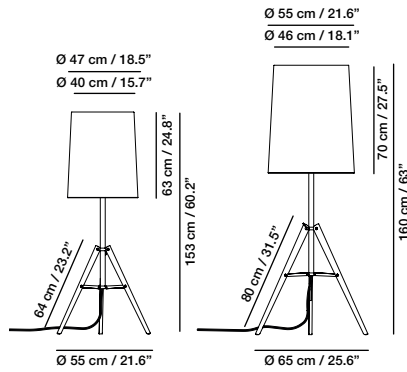

Estructura: madera de roble y metal (beige)

Structure: oak wood and metal (beige)

2661000

Pantalla: lino

h 153 cm / 60.2"

Shade: linen

h 153 cm / 60.2"

860,00

2651000

h 160 cm / 63"

h 160 cm / 63"

950,00

2661100

Pantalla: sagurán (fibra natural)

h 153 cm / 60.2"

Shade: saguran (natural fiber)

h 153 cm / 60.2"

890,00

2651100

h 160 cm / 63"

h 160 cm / 63"

950,00

Equipada con interruptor

Equipped with switch

Sin bombilla

Without bulb

2 x E27 LED

2 x E27 LED

100 W / 220-240 V / 50-60 Hz

100 W / 220-240 V / 50-60 Hz



Twist

COLGANTE / SUSPENSION LAMP

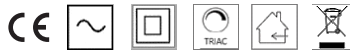
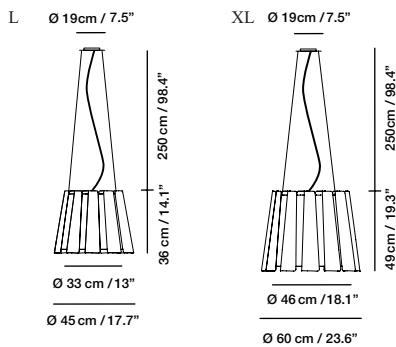

Estructura: aluminio lacado brillante

Structure: shiny lacquered aluminum

4131001

L (Ø45 cm / 17.7")

Blanco

L (Ø45 cm / 17.7")

White

760,00

4121001

XL (Ø60 cm / 23.6")

Blanco

XL (Ø60 cm / 23.6")

White

980,00

4111001

XXL (Ø90 cm / 35.4")

Blanco

XXL (Ø90 cm / 35.4")

White

1.650,00

Equipada con cable eléctrico de 2,75 m (108,2")

Equipped with 2,75 m (108,2") of electric cable

Sin bombilla

Without bulb

L (Ø 45 cm / 17.7"):

2 x E27 LED

20 W / 220-240 V / 50-60 Hz

L (Ø 45 cm / 17.7"):

2 x E27 LED

20 W / 220-240 V / 50-60 Hz

XL (Ø60 cm / 23.6"):

3 x E27 LED

25 W / 220-240 V / 50-60 Hz

XL (Ø60 cm / 23.6"):

3 x E27 LED

25 W / 220-240 V / 50-60 Hz

XXL (Ø90 cm / 35.4"):

4 x E27 LED

25 W / 220-240 V / 50-60 Hz

XXL (Ø90 cm / 35.4"):

4 x E27 LED

25 W / 220-240 V / 50-60 Hz

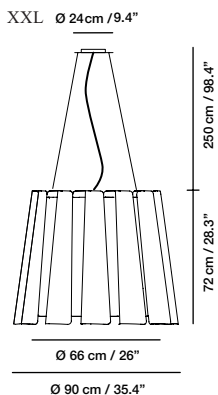



MODELO COD. ACABADOS FINISHES EUROS

Venus IN / OUTDOOR
 APLIQUE-PLAFÓN / WALL-CEILING LAMP

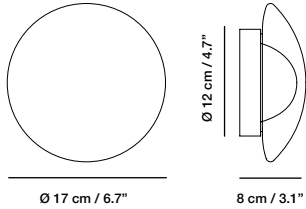

2051100	Estructura: Cristal	Structure: Glass	325,00
	Sin interruptor	Without switch	
	Bombilla incluida LED GX53 6 W / 220-240 V / 50-60 Hz	Bulb included LED GX53 6 W / 220-240 V / 50-60 Hz	
			



Yoko
 APLIQUE / WALL LAMP

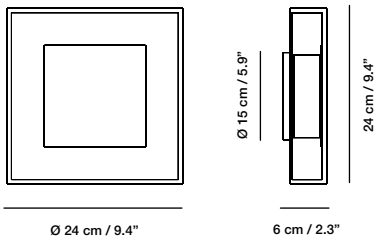









	Estructura: metal	Structure: metal	398,00 650,00 520,00
2081100	Blanco	White	
2081000	Pan de oro	Gold leaf	
2081001	Grafito níquel metalizado	Metallic graphite nickel	
	Incluye dos fuentes de luz: superior e inferior	Two light sources: upper and lower	
	Sin interruptor	Without switch	
	LED INTEGRADO 15 W / 120-240 V / 50-60 Hz 2 x 704 Lumen / 2700 K / CRI 90	INTEGRATED LED 15 W / 120-240 V / 50-60 Hz 2 x 704 Lumen / 2700 K / CRI 90	



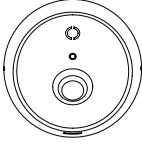
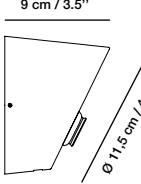
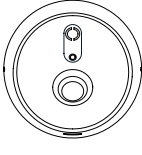

Solicitar presupuesto / Price upon request

MODELO	COD.	ACABADOS	FINISHES	EUROS
Zoom APLIQUE / WALL LAMP		        		
		Cuerpo: policarbonato y ABS Superficie de laminado personalizable USB de carga	Body: polycarbonate and ABS Customizable laminate surface Charging USB	
 Ø 11,7 cm / 4.6"	 9 cm / 3.5" Ø 11,5 cm / 4.5"	1004001 Terracota 1004002 Mostaza 1004003 Caqui 1004004 Azul 1004005 Gris 1004007 Cuero negro 1004010 Olmo	Terracotta Mustard Khaki Blue Grey Black leather Elm	345,00 345,00 345,00 345,00 345,00 345,00 345,00
 Ø 11,7 cm / 4.6"		1004006 Cobre rosa 1004008 Oro 1004009 Carbón	Pink copper Gold Carbon	345,00 345,00 345,00
		Más de 1000 acabados diferentes. Colores bajo pedido Interruptores táctiles	More than 1000 different finishes. Colours upon request Touch switches	
		LED INTEGRADO 4 W perimetral 2700 K + 2 W spot 3000 K / 100-240 V / 50-60 Hz / 120-80 Lumen / CRI 80	INTEGRATED LED 4 W perimetral 2700 K + 2 W spot 3000 K / 100-240 V / 50-60 Hz / 120-80 Lumen / CRI 80	
		Foco orientable con la apertura del LED ajustable Luz perimetral de ambiente USB: 2,5 Amp. máx.	Adjustable focus with adjustable LED aperture Ambient perimeter light USB: 2,5 Amp. max.	

MODELO	COD.	ACABADOS	FINISHES	EUROS
--------	------	----------	----------	-------

Florón A / Canopy A

Los precios no incluyen colgantes / Prices do not include pendant lamps

Florón A3 / Canopy A3

Ø 35 cm / 13.77"



Ø 30,4 cm / 11.9"

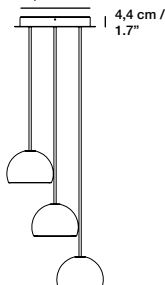

Florón A5 / Canopy A5

Ø 35 cm / 13.77"



Ø 30,4 cm / 11.9"

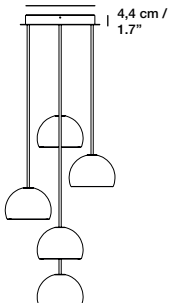

ACC2001
ACC2007
ACC2013
ACC2019

Estructura: metal
Lámparas hasta Ø 21 cm

Structure: metal
Lamps up to Ø 21 cm

LÁMPARAS COMPATIBLES / COMPATIBLE LAMPS

Colette (Ø20cm / Ø40cm), Mei difusor A B y C, y Neil (Ø 11cm / Ø15 cm / Ø 21 cm)

FLORÓN A3 (Ø35 cm / 13,7")
Apto para 3 Colgantes

CANOPY A3 (Ø35 cm / 13,7")
Suitable for 3 Pendant lamps

Blanco
Negro
Oro
Níquel

White
Black
Gold
Nickel

310,00
310,00
310,00
310,00

FLORÓN A5 (Ø35 cm / 13,7")
Apto para 5 Colgantes

CANOPY A5 (Ø35 cm / 13,7")
Suitable for 5 Pendant lamps

ACC2002
ACC2008
ACC2014
ACC2020

Blanco
Negro
Oro
Níquel

White
Black
Gold
Nickel

315,00
315,00
315,00
315,00

Florón A7 / Canopy A7

Ø 45 cm / 17.7"



Ø 40,4 cm / 15.9"

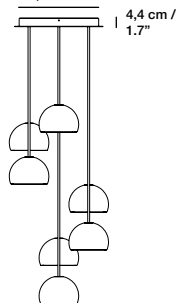

Florón A9 / Canopy A9

Ø 45 cm / 17.7"



Ø 40,4 cm / 15.9"

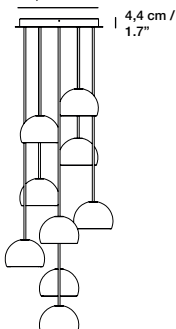

ACC2003
ACC2009
ACC2015
ACC2021

FLORÓN A7 (Ø45 cm / 17.7")
Apto para 7 Colgantes

CANOPY A7 (Ø45 cm / 17.7")
Suitable for 7 Pendant lamps

Blanco
Negro
Oro
Níquel

White
Black
Gold
Nickel

360,00
360,00
360,00
360,00

FLORÓN A9 (Ø45 cm / 17.7")
Apto para 9 Colgantes

CANOPY A9 (Ø45 cm / 17.7")
Suitable for 9 Pendant lamps

ACC2004
ACC2010
ACC2016
ACC2022

Blanco
Negro
Oro
Níquel

White
Black
Gold
Nickel

360,00
360,00
360,00
360,00

Florón A11 / Canopy A 11

Ø 60 cm / 23.6"



Ø 55,4 cm / 21.8"

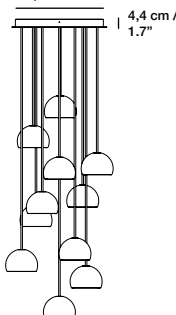

Florón A15 / Canopy A15

Ø 60 cm / 23.6"



Ø 55,4 cm / 21.8"

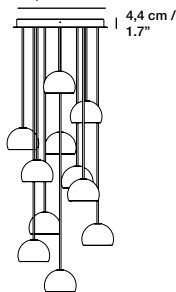

ACC2005
ACC2011
ACC2017
ACC2023

FLORÓN A11 (Ø60 cm / 23.6")
Apto para 11 Colgantes

CANOPY A11 (Ø60 cm / 23.6")
Suitable for 11 Pendant lamps

Blanco
Negro
Oro
Níquel

White
Black
Gold
Nickel

380,00
380,00
380,00
380,00

FLORÓN A15 (Ø60 cm / 23.6")
Apto para 15 Colgantes

CANOPY A15 (Ø60 cm / 23.6")
Suitable for 15 Pendant lamps

ACC2006
ACC2012
ACC2018
ACC2024

Blanco
Negro
Oro
Níquel

White
Black
Gold
Nickel

380,00
380,00
380,00
380,00

MODELO	COD.	ACABADOS	FINISHES	EUROS
--------	------	----------	----------	-------

Florón B / Canopy B

Los precios no incluyen colgantes / Prices do not include pendant lamps

Florón B3 / Canopy B3

Ø 20 cm / 7.8"



Florón B5 / Canopy B5

Ø 20 cm / 7.8"



Ø 17,4 cm / 6.8"
4,4 cm / 1.7"

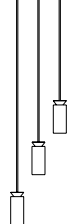

Ø 17,4 cm / 6.8"
4,4 cm / 1.7"



Estructura: metal
Lámparas hasta Ø11 cm

Structure: metal
Lamps up to Ø11 cm

FLORÓN B3 (Ø 20 cm / 7.8")
Apto para 3 Colgantes

- ACC2025 Blanco
- ACC2031 Negro
- ACC2037 Oro
- ACC2043 Níquel

CANOPY B3 (Ø 20 cm / 7.8")
Suitable for 3 Pendant lamps

- White
- Black
- Gold
- Nickel

285,00
285,00
285,00
285,00

FLORÓN B5 (Ø 20 cm / 7.8")
Apto para 5 Colgantes

- ACC2026 Blanco
- ACC2032 Negro
- ACC2038 Oro
- ACC2044 Níquel

CANOPY B5 (Ø 20 cm / 7.8")
Suitable for 5 Pendant lamps

- White
- Black
- Gold
- Nickel

285,00
285,00
285,00
285,00

Florón B7 / Canopy B7

Ø 30 cm / 11.8"



Florón B9 / Canopy B9

Ø 30 cm / 11.8"



Ø 25,4 cm / 10"
4,4 cm / 1.7"

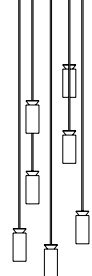

Ø 25,4 cm / 10"
4,4 cm / 1.7"

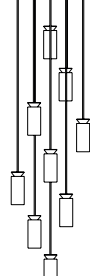

FLORÓN B7 (Ø 35 cm / 13.7")
Apto para 5 Colgantes

- ACC2027 Blanco
- ACC2033 Negro
- ACC2039 Oro
- ACC2045 Níquel

CANOPY B7 (Ø 35 cm / 13.7")
Suitable for 7 Pendant lamps

- White
- Black
- Gold
- Nickel

310,00
310,00
310,00
310,00

FLORÓN B9 (Ø 35 cm / 13.7")
Apto para 9 Colgantes

- ACC2028 Blanco
- ACC2034 Negro
- ACC2040 Oro
- ACC2046 Níquel

CANOPY B9 (Ø 35 cm / 13.7")
Suitable for 9 Pendant lamps

- White
- Black
- Gold
- Nickel

310,00
310,00
310,00
310,00

Florón B11 / Canopy B11

Ø 35 cm / 13.77"



Florón B15 / Canopy B15

Ø 35 cm / 13.77"



Ø 31,9 cm / 12.5"
4,4 cm / 1.7"

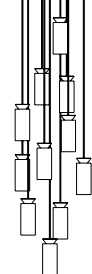

Ø 31,9 cm / 12.5"
4,4 cm / 1.7"

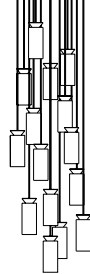

FLORÓN B11 (Ø 35 cm / 14.17")
Apto para 11 Colgantes

- ACC2029 Blanco
- ACC2035 Negro
- ACC2041 Oro
- ACC2047 Níquel

CANOPY B11 (Ø 35 cm / 14.17")
Suitable for 11 Pendant lamps

- White
- Black
- Gold
- Nickel

330,00
330,00
330,00
330,00

FLORÓN B15 (Ø 35 cm / 14.17")
Apto para 15 Colgantes

- ACC2030 Blanco
- ACC2036 Negro
- ACC2042 Oro
- ACC2048 Níquel

CANOPY B15 (Ø 35 cm / 14.17")
Suitable for 15 Pendant lamps

- White
- Black
- Gold
- Nickel

330,00
330,00
330,00
330,00















LÁMPARAS COMPATIBLES:

Pippet (0,19 kg)
Triana 2 (0,75 kg)
Neil Ø 11 cm / 4.3" (0,68 kg)

COMPATIBLE LAMPS:

Pippet (0,19 kg)
Triana 2 (0,75 kg)
Neil Ø 11 cm / 4.3" (0,68 kg)

Bombillas / Bulbs

MODELO	COD.	DESCRIPCIÓN / DESCRIPTION	LAMP.	EUROS
	BOM1135	GU10 LED* 9,5 W 950 Lumen 3000 K 	No dimerizable / Not dimmable Triana	32,00
	BOM1115	Par 30 LED* 10 W 850 Lumen 3000 K 	No dimerizable / Not dimmable Macao	39,50
	BOM1097	E27 LED* 11 W 1055 Lumen 3000 K 	No dimerizable / Not dimmable Aitana, Carla, Galilea, Garçon applique grande/large wall lamp & Garçon pie/ floor lamp, Greta, Harry, Harry plus, Isamu, Jerry, Lektor, Mandarinina, Mei A & B, Melina, Nirvana, Tiffany, Totoro, Tripod, Twist, Sasha, Woody	19,50
	BOM1114	GX53 LED* 6 W 500 Lumen 3000 K 	No dimerizable / Not dimmable Códol, Happy, Venus	40,00
	BOM1015	E27 Ø95 Full Glass* 9 W 720 Lumen 2700 K 	No dimerizable / Not dimmable Punt, Robin, Robinson	44,00
	BOM1043	E27 Bajo Consumo* 23 W 1600 Lumen 2700 K 	No dimerizable / Not dimmable Mei C	24,00
	BOM1044	E27 Ø95 LED* 7 W 750 Lumen 2700 K 	No dimerizable / Not dimmable El cubo	35,00

*220-240V

Notas / Notes

A series of horizontal dotted lines for writing notes.

Condiciones de venta

PORTES, ENVÍOS Y PEDIDO MÍNIMO

Pedidos nacionales superiores a 200,00€ (Netos sin IVA) se remitirán a portes pagados (excepto Canarias, Ceuta, Melilla y Andorra).

Pedidos nacionales que no superen los 200,00€ (Neto sin IVA) tendrán el coste de transporte siguiente:

- Catalunya (Barcelona incluida): 15,00€ por envío.
- Resto de España: 25,00€ por envío (excepto Canarias, Ceuta, Melilla y Andorra).

PEDIDOS QUE NO SUPEREN LOS 100,00€ NETOS, SE PAGARÁN POR ADELANTADO

- Para nuevos clientes, primer pedido mínimo 1.500,00€ (neto sin IVA).
- Pedidos mínimos de reposición: 200,00€ (Neto sin IVA).
- Solo se aceptarán pedidos por mail: comercial@carpyen.com

Pedidos especiales y/o personalizados: antony@carpyen.com

Nota: Las bombillas NO están incluidas excepto donde esté indicado.

IMPORTANTE: RECLAMACIÓN EN UN PLAZO MÁXIMO DE 48 HORAS

- Sin el embalaje original, no se aceptará ninguna reclamación.
- En el momento de la entrega, y en presencia del transportista, le rogamos que compruebe:
 - Que el número de palés y paquetes corresponde al albarán de entrega.
 - El estado aparente de los paquetes ante el conductor (paquetes dañados o abiertos).
- En caso de faltantes o daños a la llegada, tome sistemáticamente fotos de los palés/paquetes afectados y haga reservas fechadas en el bono de transporte (waybill o CMR), detallando el estado de los bultos y, en su caso, las piezas dañadas y su importe.
- Dispone de 3 días a partir de la entrega para comprobar con precisión la mercancía y confirmar estas reservas con el transportista por correo certificado.
- Tenga en cuenta que menciones como “pendiente a verificar” o “paquete perdido” sin ninguna información adicional no justifican un litigio.
- Las reservas deben ser claras, precisas y motivadas.

Condiciones para exportación

PORTES, ENVÍOS Y PEDIDO MÍNIMO

Los pedidos de exportación (CE) que superen los 500,00€ serán enviados gratuitamente, a excepción de:

- Escandinavia
- Países de los Balcanes
- Bulgaria
- Reino Unido
- Irlanda
- Suiza
- y TODAS las islas europeas

Los pedidos que no superen el mínimo de 500,00€ tendrán un coste de transporte de 50,00€, excepto para los países mencionados anteriormente.

TODOS LOS DEMÁS PAÍSES EX-WORKS

PEDIDOS QUE NO SUPEREN LOS 100,00€ NETOS, SE PAGARÁN POR ADELANTADO

- Para los nuevos clientes, primer pedido mínimo de 1.500,00€.
- Sólo se aceptan pedidos por correo electrónico: export@carpyen.com

Pedidos especiales y/o a medida: antony@carpyen.com

Nota: Las bombillas NO están incluidas, excepto cuando este indicado.

IMPORTANTE: RECLAMACIÓN EN UN PLAZO MÁXIMO DE 48 HORAS

- Sin el embalaje original, no se aceptará ninguna reclamación.
- En el momento de la entrega, y en presencia del transportista, le rogamos que compruebe:
 - Que el número de palés y paquetes corresponde al albarán de entrega.
 - El estado aparente de los paquetes ante el conductor (paquetes dañados o abiertos).
- En caso de faltantes o daños a la llegada, tome sistemáticamente fotos de los palés/paquetes afectados y haga reservas fechadas en el bono de transporte (waybill o CMR), detallando el estado de los bultos y, en su caso, las piezas dañadas y su importe.
- Dispone de 3 días a partir de la entrega para comprobar con precisión la mercancía y confirmar estas reservas con el transportista por correo certificado.
- Tenga en cuenta que menciones como “pendiente a verificar” o “paquete perdido” sin ninguna información adicional no justifican un litigio.
- Las reservas deben ser claras, precisas y motivadas.

Terms and conditions

PORTS, SHIPPING AND MINIMUM ORDER

National orders over 200,00€ (Net without VAT) will be sent carriage paid (except Canary Islands, Ceuta, Melilla and Andorra).

National orders not exceeding 200,00€ (Net without VAT) will have the following shipping cost:

- Catalonia (Barcelona included): 15,00€ per shipment.
- Rest of Spain: 25,00€ per shipment (except Canary Islands, Ceuta, Melilla and Andorra).

ORDERS NOT EXCEEDING 100,00€ NET, TO BE PAID IN ADVANCE

- For new customers, first order minimum € 1.500,00 (net without VAT)
- Reorders minimum: 200,00€ (Net without VAT)
- Only orders by mail will be accepted: comercial@carpyen.com

Special and/or custom made orders: antony@carpyen.com

Note: Bulbs are NOT included except where indicated.

IMPORTANT: COMPLAINT WITHIN 48 HOURS MAXIMUM

- Without the original packaging, no claim can be accepted.
- At the time of delivery, and in the presence of the carrier, we ask you to check:
 - That the number of pallets and packages corresponds to the delivery note.
 - The apparent state of the packages in front of the driver (damaged or open packages)..
- In the event of shortages or damage upon arrival, systematically take photos of the affected pallets/packages and make dated reservations on the transport voucher (waybill or CMR), detailing the status of the packages and, if applicable, the damaged parts and its amount.
- You have 3 days from delivery to accurately check the merchandise and confirm these reservations with the carrier by certified mail.
- Please note that mentions such as "subject to count" or "parcel missing" without any additional information do not justify a dispute.
- Reservations must be clear, precise and motivated.

Export terms and conditions

PORTS, SHIPPING AND MINIMUM ORDER

Export orders within the EC that exceed 500,00€ will be sent free of charge. Exception of:

- Scandinavia
- Balkan countries
- Bulgaria
- Uk
- Ireland
- Switzerland
- And ALL European Islands

Orders that do not exceed the minimum of 500,00€ will have a transport fee of 50,00€. Except for countries mentioned above.

ALL OTHER COUNTRIES EX-WORKS

ORDERS NOT EXCEEDING 100,00€ NET, TO BE PAID IN ADVANCE

- For new customers, first order minimum € 1.500,00
- Only orders by mail will be accepted: export@carpyen.com

Special and/or custom made orders: antony@carpyen.com

Note: Bulbs are NOT included except where indicated.

IMPORTANT: COMPLAINT WITHIN 48 HOURS MAXIMUM

- Without the original packaging, no claim can be accepted.
- At the time of delivery, and in the presence of the carrier, we ask you to check:
 - That the number of pallets and packages corresponds to the delivery note.
 - The apparent state of the packages in front of the driver (damaged or open packages)..
- In the event of shortages or damage upon arrival, systematically take photos of the affected pallets/packages and make dated reservations on the transport voucher (waybill or CMR), detailing the status of the packages and, if applicable, the damaged parts and its amount.
- You have 3 days from delivery to accurately check the merchandise and confirm these reservations with the carrier by certified mail.
- Please note that mentions such as "subject to count" or "parcel missing" without any additional information do not justify a dispute.
- Reservations must be clear, precise and motivated.

Condiciones generales de venta

ARTÍCULO 1

Estas condiciones generales de venta constituyen el régimen general que rige las ventas de CARPYEN, las cuales cancelan y reemplazan aquellas que pueda haber distribuido antes esta empresa. Ninguna condición especial o excepción puede, salvo que el vendedor lo acepte formalmente y por escrito, prevalecer sobre estos términos y condiciones generales. El hecho de que el vendedor no aproveche una de estas condiciones generales de venta en un momento dado no debe interpretarse como que implica que ha renunciado a aprovechar una de estas condiciones en una fecha posterior.

ARTÍCULO 2

Cualquier pedido hecho solo será definitivo siempre y cuando CARPYEN no lo rechace dentro de un período de 10 días a partir de la recepción del pedido por parte del vendedor. Como consecuencia, CARPYEN se reserva el derecho de no actuar sobre los compromisos asumidos por sus representantes o empleados. Por acuerdo expreso de las partes, si el vendedor no celebra un contrato no puede ocasionar daños de ningún tipo que se puedan pagar al comprador. El beneficio del pedido es personal para el comprador y no puede transferirse sin el acuerdo del vendedor.

ARTÍCULO 3

El vendedor se reserva el derecho, por iniciativa propia, de hacer modificaciones menores, en particular con respecto a la forma, el color, las dimensiones o los materiales utilizados en las colecciones que ha presentado, cualquiera que sea el canal publicitario utilizado, que no comprometan la apariencia del producto.

En lo que respecta a pedidos específicos, es decir, pedidos de bienes que no forman parte de la colección que ofrece el vendedor, los términos de la oferta de CARPYEN se refieren exclusivamente a los términos del presupuesto que ha preparado este último. En caso de necesidad, el vendedor mantiene la opción de sustituir bienes que considere de calidad equivalente. Esta oferta será válida durante el período especificado dentro de la oferta según lo determine el vendedor.

ARTÍCULO 4

En función de las fluctuaciones del mercado:

- Los precios solo son válidos durante el período indicado en este documento. El precio firme y definitivo es el precio vigente al momento de la aceptación del pedido por parte del vendedor.

Los bienes vendidos (tanto en lo que respecta a los pedidos iniciales como al reabastecimiento) solo se suministrarán dentro de los límites de las existencias disponibles. El comprador, al reconocer y aceptar el principio, acuerda como consecuencia no iniciar ningún procedimiento contra el vendedor en este contexto.

El comprador no puede confiar bajo ninguna circunstancia en estándares, especificaciones, requisitos, regulaciones y prácticas normales que no haya aceptado específicamente el vendedor.

En el caso de transacciones que involucren grandes cantidades que normalmente no se mantienen en stock, el plazo de entrega se acordará las partes.

ARTÍCULO 5

Todos los precios emitidos por CARPYEN son precios netos. Cualquier descuento vinculado a una cantidad o una promoción, etc. debe estar sujeto a un acuerdo previo por escrito entre el vendedor y el comprador.

ARTÍCULO 6

Los métodos de parcelado, empaquetado y agrupamiento son los vigentes dentro de la empresa CARPYEN. El transporte se liquida mediante los INCOTERMS 2010 (Términos Comerciales Internacionales de 2010).

Cualquiera que sea el método de entrega seleccionado y el lugar de entrega elegido, el comprador asume la responsabilidad total de todos los riesgos a los que los bienes pueden estar sujetos desde que el vendedor inicia el envío. El envío se considera desde el momento en que los bienes almacenados en las instalaciones del vendedor se transfieren a la empresa de transporte con el fin de la entrega o se transfieren al comprador en caso de entrega en fábrica, o en la presentación de los bienes por la empresa de transporte en caso de entrega por transporte pagado. En caso de daños o pérdidas, es responsabilidad del comprador comunicarlo dentro de los 2 días posteriores a la recepción de la mercancía e informar del problema a la empresa de transporte que ha utilizado CARPYEN por carta certificada con un formulario de acuse de recibo cuando el vendedor proporciona el transporte. Solo con el cumplimiento de este procedimiento permitirá a CARPYEN emitir un crédito por los bienes dañados o reemplazarlos. Los productos dañados durante el transporte no son productos que faltan en la entrega, sino productos entregados y facturados que, cuando se cumple el procedimiento de declaración, están sujetos a reembolso o reemplazo a discreción de CARPYEN. El comprador no puede basarse en los daños durante el transporte para responsabilizar al vendedor por no cumplir con sus compromisos.

Los plazos de entrega o envío son indicativos y la superación de estos plazos no da derecho al comprador de cancelar el pedido. Las sanciones por incumplimiento de la tarifa del servicio solo se pueden aplicar según los términos del artículo 9.

Las partes decidirán el método de transporte y los costos relacionados con este servicio para entregas fuera de España cuando se recibe el pedido.

Además, en caso de fuerza mayor o circunstancias fuera de su control liberan a CARPYEN de todos los compromisos de entrega. Todas las causas no atribuibles que impiden o detienen la fabricación o entrega del vendedor o la fabricación o entrega de sus proveedores se consideran casos de fuerza mayor o circunstancias fuera del control de CARPYEN.

ARTÍCULO 7

Sin perjuicio del procedimiento a seguir respecto a la empresa de transporte, las quejas relacionadas con defectos obvios o con la no conformidad del producto entregado deben expresarse por escrito y enviarse al vendedor dentro de los 2 días posteriores a la entrega de la mercancía. Es responsabilidad del comprador proporcionar evidencia sobre la realidad de los fallos o defectos. El comprador debe dar al vendedor todas las oportunidades para determinar la naturaleza de estos defectos. Además, el comprador debe abstenerse de llevar a cabo cualquier manipulación sobre los productos que estén sujetos a disputa, aunque sea a través de un tercero, salvo que el vendedor lo haya acordado previamente por adelantado.

No se pueden devolver los bienes sin el acuerdo por escrito del vendedor y la aceptación de dichos bienes no implica el reconocimiento de responsabilidad por parte de este último. Todos los productos que se devuelvan sin dicho acuerdo permanecerán disponibles para el comprador y no darán lugar a la creación de un crédito. Los gastos y riesgos inherentes a la devolución de los bienes son siempre responsabilidad del comprador.

En cualquier caso, la responsabilidad de CARPYEN, en la medida en que se incurre, está estrictamente limitada a la obligación de reemplazar o reembolsar los productos defectuosos o no conformes como se indica en este artículo.

ARTÍCULO 8

El embalaje no se devuelve al vendedor, siendo su costo, excepto cuando hay condiciones especiales que indiquen lo contrario, una parte integral del precio cotizado al comprador. Sin embargo, estos precios no pueden cubrir procedimientos de embalaje especiales que haya solicitado el comprador y aceptado el vendedor.

Si no hay ninguna indicación especial, el vendedor se encarga del embalaje. El embalaje de CARPYEN está totalmente aprobado por el comprador, por lo que este último se compromete a liberar a CARPYEN de cualquier procedimiento dirigido contra él por ello.

ARTÍCULO 9

CARPYEN ofrece productos decorativos de calidad para su venta vinculados a las tendencias de decoración. Estos productos se suministran en la medida en que están disponibles en stock y la empresa anticipa el lanzamiento de compras y fabricación en relación con el potencial del mercado. La empresa no acepta sanciones vinculadas a un concepto de tarifa de servicio que no forme parte de un acuerdo previo con el comprador, un acuerdo que debe especificar una lista de los productos en cuestión y las previsiones de consumo emitidas por el comprador y el cálculo de las cuales cumple con el método de cálculo definido en el Código de Buena Conducta para Prácticas Comerciales entre Profesionales en el Comercio de Decoración Apéndice IV firmado el 22 de abril de 2005 por F.M.B. y UNIBAL.

ARTÍCULO 10

Todas las facturas se pagan a nuestra oficina central en Barcelona. Todos los pedidos son pagaderos en factura proforma. Se solicita un depósito del 30 % del monto total del pedido para confirmarlo. El pago se liquida mediante transferencia bancaria.

Cualquier monto no liquidado en el momento de su vencimiento dará lugar automáticamente y sin la necesidad de una notificación oficial previa a multas por pagos atrasados calculados sobre el monto restante adeudado a tres veces la tasa de interés legal vigente en ese momento. Además, el comprador deberá una indemnización fija de cobro de 40 € en caso de retraso en el pago de cualquier deuda cuyo plazo de pago comenzaría después del 1 de enero de 2013.

Los intereses y la compensación de cobro fijo de 40 € se incurre desde el día siguiente a la fecha de vencimiento hasta el pago total de los montos adeudados. Además, la falta de pago de una sola factura significa que los montos adeudados a CARPYEN por otras facturas que permanecen pendientes de pago se vuelven pagaderos de forma inmediata. Todos los montos en cuestión incurrir en intereses de inmediato de acuerdo con los procedimientos definidos en este párrafo.

Se considera que las facturas se han pagado cuando el importe que se muestra en ellas se acredita a la cuenta bancaria de CARPYEN.

Todas las deducciones o compensaciones se excluyen específicamente, excepto cuando se acuerde específicamente por adelantado con CARPYEN. En caso de una deducción o compensación indebida hecha por el comprador, se calculará una multa sobre los montos deducidos incorrectamente de acuerdo con el método de cálculo de las multas por pago atrasado según lo establecido en este artículo.

ARTÍCULO 11

En caso de retraso en el pago, y sin perjuicio de la aplicación del principio descrito en el artículo 8 de este documento, el vendedor puede, a su propia discreción:

- Suspender sus obligaciones con respecto al pedido afectado por el retraso, así como todos los pedidos actuales, hasta que se paguen en su totalidad todas las sumas adeudadas por el comprador.

- Cancelar la venta automáticamente. El vendedor puede solicitar un requerimiento provisional para la devolución de los bienes involucrados sin perjuicio del pago de daños a este respecto.

Esta terminación no solo afectará al pedido actual, sino también, si el vendedor lo desea, a todos los pedidos anteriores o futuros no pagados, se hayan entregado o estén en curso de entrega y si el pago se debe o no. El comprador debe reembolsar todos los costos incurridos por la recuperación contenciosa de las sumas adeudadas. El vendedor retendrá todos los pagos anticipados que ha hecho el comprador.

ARTÍCULO 12

Cualquier deterioro en la solvencia crediticia del comprador, el incumplimiento por parte de este último de los términos del negocio actual especificado por CARPYEN y, de forma general, cualquier cambio en las circunstancias del comprador, sea cual sea la causa, puede justificarse mediante un acuerdo específico entre las partes, el requisito de una garantía o procedimientos especiales de pago especificados por el vendedor, incluso la negativa de CARPYEN a proceder con los pedidos hechos por el comprador.

ARTÍCULO 13

Todas nuestras ventas están sujetas a la retención del título hasta el pago total del precio por parte del comprador. Por lo tanto, la transferencia de propiedad de los bienes suministrados al comprador está subordinada al pago efectivo del precio completo, capital, intereses y gastos incidentales incluidos. Sin embargo, se entiende que la simple entrega de un pedido que crea una obligación de pago, ya sea una letra de cambio u otro instrumento similar, no constituye un pago en el sentido de esta cláusula.

La deuda original del vendedor en relación con el comprador permanece con todas las garantías que se le atribuyen, incluida la reserva de título, hasta que dicha factura comercial se haya pagado efectivamente de conformidad con el artículo 10 de estas condiciones generales de venta.

Las disposiciones anteriores no constituyen un impedimento en la entrega de los bienes a la transferencia al comprador de los riesgos asociados con la pérdida o el deterioro de los bienes sujetos a la reserva de la propiedad, así como cualquier daño que puedan causar.

El comprador debe contratar un seguro para cubrir los riesgos que surjan de la entrega de los bienes.

Mientras no se paguen los bienes en su totalidad, el comprador debe mantener los bienes separados con respecto a este contrato y no debe mezclarlos con otros bienes del mismo tipo originarios de otros proveedores. En caso de que el comprador no mantenga los productos separados, el vendedor puede solicitar un reembolso o recuperar los que aún están en stock.

En caso de incautación o cualquier otra intervención de un tercero en relación con los bienes, el comprador tiene la obligación de informar al vendedor sin demora, lo que permite a este último oponerse a la incautación y preservar sus derechos.

Además, el comprador debe abstenerse de prometer o transferir la propiedad de los bienes como garantía.

El comprador está autorizado, en el contexto del funcionamiento normal de su establecimiento, a revender los bienes que son objeto de este contrato. Sin embargo, antes de venderlos está obligado, a discreción del vendedor, a pagar de inmediato el saldo del precio que aún le debe al vendedor o informar a los subcompradores que los bienes en cuestión están sujetos a una cláusula de reserva de título e informar al vendedor sobre esta transferencia para que pueda preservar sus derechos y, de ser necesario, hacer un reclamo sobre el precio de reventa con respecto al subcomprador.

ARTÍCULO 14

Si no se llega a un acuerdo amistoso, el vendedor y el comprador acuerdan específicamente que todas las disputas, dificultades de interpretación, terminación, consecuencias y repercusiones de los presentes términos estarán sujetas a la jurisdicción del tribunal de nuestro domicilio social, incluso en el caso de múltiples acusados o inclusión de terceros. Las condiciones generales de venta, las transacciones de compra y venta resultantes de las mismas y cualquier otro documento se rigen por la legislación española.

General Terms of Sales

ARTICLE 1

These general conditions of sale constitute the general regime governing CARPYEN's sales. They cancel and replace those that may have been distributed earlier by this Company. No special condition and/or exception can, except where the vendor agrees to it formally and in writing, take precedence over these general terms and conditions. The fact that the vendor does not take advantage of one of these general conditions of sale at any given moment, should not be interpreted as implying that it has renounced taking advantage of one of these conditions at a later date.

ARTICLE 2

Any order taken only becomes definitive to the extent that it is not rejected by CARPYEN within a period of 10 days as from receipt of the order by the vendor. As a result of this, CARPYEN reserves the right not to act on commitments made by its representatives or employees. By express agreement of the parties, failure on the part of the vendor to enter into a contract cannot lead to damages of any sort being payable to the purchaser. The benefit of the order is personal to the purchaser and may not be transferred without the vendor's agreement.

ARTICLE 3

The vendor reserves the right at its own initiative alone, to make minor modifications, in particular concerning the shape, color, dimensions or materials used in the collections it has presented, whatever the advertising channel used, that do not compromise the appearance of the product. As far as specific orders are concerned - by this is meant orders for goods that are not part of the collection offered by the vendor - the terms of the offer made by CARPYEN relate exclusively to the terms of the quotation prepared by the latter. In case of necessity, the vendor retains the option of substituting goods that it deems to be of equivalent quality. This offer will be valid for the period specified within the offer as determined by the vendor.

ARTICLE 4

In the light of market fluctuations:

•Prices are only valid for the period indicated in this document. The firm and final price is the price in force on acceptance of the order by the vendor.

Goods sold (both as far as initial orders and resupplying are concerned) will only be supplied within the limits of available stock - the purchaser, recognizing and accepting the principle, and as a consequence agreeing not to initiate any proceedings against the vendor in this context.

Under no circumstances may the purchaser rely on standards, specifications, requirements, regulations and normal practice not specifically accepted by the vendor.

In the case of transactions involving large quantities not normally kept in stock, the delivery deadline must be agreed by the parties.

ARTICLE 5

All prices issued by CARPYEN are net prices. Any discount linked to a quantity or a promotion, etc. must be the subject of a prior written agreement between the vendor and the purchaser.

ARTICLE 6

The methods of parceling, packaging and grouping are those in force within the CARPYEN Company. The transport is settled by the INCOTERMS 2010 (International Commercial Terms of 2010).

Whatever the method of delivery selected and the place of delivery chosen, the purchaser bears full responsibility for all risks to which the goods may be subject from their release by the vendor. Release is considered as being from the time when the goods stored in the vendor's premises are handed over to the transport company for the purpose of delivery or handed over to the purchaser in case of delivery ex-works, or on presentation of the goods by the transport company in case of delivery carriage paid. In case of damage and/or loss, it is the purchaser's responsibility to express its concerns within 2 days of receipt of the goods and to inform the transport company used by CARPYEN of the dispute by registered letter with a form for acknowledgement of receipt when transport is provided by the vendor. Only compliance with this procedure will enable CARPYEN to issue a credit for the damaged goods or replace them. Products damaged during transport are not products missing from the delivery, but products delivered and invoiced which, when the declaration procedure is complied with, are subject to reimbursement or replacement at CARPYEN's discretion. The Purchaser may not rely on damage during transport to hold the Vendor responsible for not complying with its commitments.

Delivery or release deadlines are given as an indication only, and when these deadlines are exceeded, this does not give the purchaser the right to cancel the order. Any penalties for a service rate failure can only be applied under the terms of article 9.

The method of transport and the costs relating to this service for deliveries outside mainland France will be decided by the parties when the order is taken

In addition, force majeure or circumstances outside its control releases CARPYEN from all delivery commitments. All causes not-attributable to the vendor impeding or halting manufacturing and/or delivery or its suppliers' manufacturing and/or delivery are considered as cases of force majeure or circumstances outside CARPYEN's control.

ARTICLE 7

Without prejudice to the procedure to be followed in relation to the transport company, complaints concerning obvious faults or concerning the non-conformity of the product delivered must be expressed in writing and sent to the vendor within 2 days as from delivery of the goods. It is the purchaser's responsibility to supply evidence as to the reality of the defects or faults observed. The purchaser must give the vendor every opportunity to ascertain the nature of these faults. The purchaser must in addition, except where previously specifically agreed by the vendor in advance, refrain from carrying out any work on the goods that are subject to dispute either itself or via a third-party.

No goods can be returned without the written agreement of the vendor and acceptance of such goods does not imply recognition of liability by the latter. All products returned without such agreement will remain available to the purchaser and will not give rise to the creation of a credit. The expenses and risks inherent to the return of goods are always the purchaser's responsibility.

In any case, CARPYEN's liability, to the extent that it is incurred, is strictly limited to the obligation to replace or reimburse the defective and/or non-compliant goods as stated in this article.

ARTICLE 8

Packaging is not taken back by the vendor, its cost being, except where there are special conditions to the contrary, an integral part of the price quoted to the purchaser. These prices cannot however cover special packing procedures requested by the purchaser and accepted by the vendor.

In the absence of any special indications, the packaging is prepared by the vendor - packaging carried out by CARPYEN being fully approved by the purchaser, the latter as a result undertakes to release CARPYEN from any proceedings directed against it on this basis.

ARTICLE 9

CARPYEN offers quality decorative products for sale linked to decorating trends. These products are supplied to the extent that they are available in stock, the Company anticipating the launch of procurement and manufacturing in relation to market potential.

The Company accepts no penalties linked to a concept of service rate, that are not part of a prior agreement with the purchaser, an agreement that should in particular specify a list of the products concerned and consumption forecasts issued by the purchaser and the calculation of which complies with the method of calculation defined in the Code of Good Conduct for Commercial Practice between Professionals in the Decorating Trade Appendix IV signed on 22 April 2005 by F.M.B. and UNIBAL.

ARTICLE 10

All invoices are payable at our head office, in Barcelona. All orders are payable on proforma invoice. A deposit of 30% of the total amount of the order is requested to confirm the order. The payment is settled by bank transfer.

Any amounts not settled when they become due will automatically and without the need for prior official notification give rise to late payment penalties calculated on the amount remaining due, at three times the legal interest rate in force at the time. Moreover, a fixed collection compensation of 40 € will be owed by the purchaser in case of delay in payment of any debt whose term payment would have begun after the 1st January 2013.

Interest and fixed collection compensation of 40€ are incurred from the day following the due date until full payment of the amounts due. In addition, non-payment of a single invoice means that amounts owed to CARPYEN from other invoices that remain outstanding automatically become payable immediately - all the amounts in question immediately incur interest according to the procedures defined in this paragraph.

Invoices are considered as having been paid when the amount shown on them is credited to CARPYEN's bank account.

All deductions and/or set-off are specifically excluded except where specifically agreed in advance with CARPYEN. In case of improper deduction or set-off made by the purchaser, a penalty will be calculated on the improperly deducted amounts according to the calculation method of the late payment penalties as stated in this article.

ARTICLE 11

In circumstances of late payment - and without prejudice to the application of the principle described in article 8 of this document - the vendor may at its own discretion:

•Suspend its obligations concerning the order affected by the delay as well as all current orders until all sums owed it by the purchaser are paid in full.

•Cancel the sale automatically - the vendor being able to seek an interim injunction for the return of the goods involved without prejudice to the payment of any damages in this respect.

This termination will not only affect the current order but also - should the vendor so wish - all previous or future orders not paid for, whether they have been delivered or are in the course of delivery and whether payment for them is due or not. The purchaser must reimburse all the costs incurred by the contentious recovery of the sums due. Advance payments made by the purchaser will be retained by the vendor.

ARTICLE 12

Any deterioration in the credit-worthiness of the purchaser, non-compliance by the latter with the terms of current business specified if need be by CARPYEN and in a general manner any change in the purchaser's circumstances whatever the cause, may justify by specific agreement by the parties, the requirement of a guarantee and/or special payment procedures specified by the vendor, even the refusal by CARPYEN to proceed with orders placed by the purchaser.

ARTICLE 13

All our sales are subject to retention of title until full payment of the price by the purchaser. Therefore, the transfer of ownership to the purchaser of the goods supplied is subordinated to the effective payment of the entire price, principal, interest and incidental expenses included.

It is however understood that the simple handover of an order creating an obligation to pay, whether a bill of exchange or other such instrument, does not constitute payment within the meaning of this clause, the vendor's original debt in relation to the purchaser remaining with all the guarantees attaching to it, including reservation of title, until the aforesaid commercial bill has effectively been paid in accordance with article 10 of these general conditions of sale.

The above provisions do not constitute an impediment, on delivery of the goods, to the transfer to the purchaser of the risks associated with the loss or deterioration of the goods subject to reservation of title as well as any damage they may cause.

The purchaser must take out insurance cover for the risks that arise as from the delivery of the goods. As long as the goods have not been paid for in full, the purchaser must keep the goods supplied in respect of this contract separate and must not mix them with other goods of the same type originating from other suppliers. Should the purchaser fail to keep the goods separate, the vendor may require reimbursement or take back those still in stock.

In case of seizure, or any other intervention by a third-party in relation to the goods, the purchaser is duty bound to inform the vendor without delay, allowing the vendor to oppose the seizure and preserve its rights.

The purchaser must in addition refrain from pledging or transferring ownership of the goods as a guarantee.

The purchaser is authorized, in the context of the normal operation of its establishment, to resell the goods that are the subject of this contract. However prior to selling them, it is obliged, at the vendor's discretion, to pay the balance of the price still owing to the vendor immediately or to inform the sub-purchasers that the goods in question are subject to a clause of reservation of title and to advise the vendor of this transfer so that it can preserve its rights, and if need be, make a claim on the resale price with regard to the sub-purchaser.

ARTICLE 14

Failing an amicable agreement, the vendor and the purchaser specifically agree that all disputes, difficulty in interpretation, termination, consequences, and repercussions of the present terms, shall be subject to the jurisdiction of the court of our registered office, even in the case of multiple defendants or introduction of third parties. The General Terms of Sale, the purchase and sale transactions resulting therefrom and any other document, are governed by Spanish Law.

SÍMBOLOS / SYMBOLS

	Fabricado en la Comunidad Europea / Manufactured in the European Community
	Producto conforme normativa americana / Product approved according to American regulations
	220 Vac.
	Aparatos con toma de tierra clase I / Earthed equipment's class I
	Aparatos sin toma de tierra clase II. Doble aislamiento / Unearthed class II equipment's. Double insulation
	Clase III / Class III
	No regulable / Not dimmable
	Regulable / Dimmable
	Regulable TRIAC / Dimmable TRIAC
	Regulable DALI / Dimmable DALI
	Regulable 0-10 / Dimmable 0-10
	3 posiciones / 3 steps
	Cargador incluido / Charger included
	Batería recargable / Rechargeable battery
	Con mando / With remote control
	IP6X
	IP5X
	IPX4
	IPX5
	Cambio cristal / Glass change
	CRI 80
	CRI 90
	Interior / Indoor
	Exterior / Outdoor
	Reciclado / Recycling

YOUR PROJECT REQUESTS

WE DESIGN

Made in Barcelona

WE CREATE

100% CARPYEN

WE ADAPT

Contract Projects

CUSTOMIZING OUR PRODUCTS

From commercial to residential projects

Hotels – Restaurants – Spas – Shops – Banking
Offices – Public spaces & Private projects



CARPYEN Pere IV, 78-84 08005 T +34 93 320 99 90 www.carpyen.com